



Dahua AI Network Video Recorder

User's Manual



Foreword

General





This user's manual (hereinafter referred to be "the Manual") introduces the installation, functions and operations of the AI Network Video Recorder (AI NVR) devices (hereinafter referred to be "the Device").

Models

Series	Model
NVR2	DHI-NVR2104HS-I; DHI-NVR2108HS-I; NVR2116HS-I; DHI-NVR2104HS-P-I; DHI-NVR2104-I; DHI-NVR2108-I; DHI-NVR2116-I; DHI-NVR2204-I; DHI-NVR2208-I; DHI-NVR2216-I; DHI-NVR2104-P-I; DHI-NVR2108-8P-I; DHI-NVR2204-P-I; DHI-NVR2108HS-8P-I; DHI-NVR2208-8P-I; DHI-NVR2216-16P-I; DHI-NVR2104H-4G-I; DHI-NVR2108H-4G-I
NVR4	DHI-NVR4832-I; DHI-NVR4432-I; DHI-NVR4416-16P-I; DHI-NVR4216-16P-I; DHI-NVR4216-I; DHI-NVR4208-8P-I
NVR5	DHI-NVR5864-I; DHI-NVR5832-I; DHI-NVR5432-16P-I; DHI-NVR5216-16P-I; NVR5216-8P-I
NVR6	DHI-NVR608-32-4KS2; DHI-NVR608-128-4KS2; DHI-NVR608-64-4KS2; DHI-NVR608R-128-4KS2; DHI-NVR608R-64-4KS2; DHI-NVR616-128-4KS2; DHI-NVR616D-128-4KS2; DHI-NVR616R-128-4KS2; DHI-NVR616DR-128-4KS2; DHI-NVR616-64-4KS2; DHI-NVR616D-64-4KS2; DHI-NVR616R-64-4KS2; DHI-NVR616DR-64-4KS2

Safety Instructions

The following categorized signal words with defined meaning might appear in the manual.

Signal Words	Meaning
 CAUTION	Indicates a potential risk which, if not avoided, could result in property damage, data loss, lower performance, or unpredictable result.
 ESD	Electrostatic Sensitive Devices. Indicates a device that is sensitive to electrostatic discharge.
 TIPS	Provides methods to help you solve a problem or save you time.
 NOTE	Provides additional information as the emphasis and supplement to the text.

Revision History

Version	Revision Content	Release Time
V1.0.7	<ul style="list-style-type: none"> Added 2 models. Added "4.11.6 Cellular Network". 	August 2020
V1.0.6	<ul style="list-style-type: none"> Added "4.3.3.8 Picture Search", "4.6.4 Picture Search Playback", "4.12.7.3 Disk Health Monitoring", "4.7.3.2 Exporting/Importing Face Database" Updated "4.7.1.1 Face Detection", "4.7.1.5 Human Detection", "4.7.2.3 Face Recognition", and "4.16.1 Display" 	May 2020
V1.0.5	Added "4.3.9 Split Tracking", "4.7.2.11 Master-slave Tracking", "4.7.1.11 Analytics List", "4.7.2.12 Video Quality Analytics", "4.12.11 Setting iSCSI" and "5.4 Cluster Service".	May 2020
V1.0.4	<ul style="list-style-type: none"> Added 16 models. Added "4.2.8 Checking PoE Status" and "4.11.16 Setting Switch". Updated "4.16.1 Display". 	April 2020
V1.0.3	<ul style="list-style-type: none"> New GUI baseline, replaces all interfaces. Added AI functions. 	July 2019
V1.0.2	Updated the description of rear panel.	May 2019
V1.0.1	<ul style="list-style-type: none"> Added NVR 5216-16P-I and NVR5216-8P-I. Updated relevant info. Updated icons on the rear panel. Added video metadata function and non-motor vehicle detection function. 	September 2018

Privacy Protection Notice

As the device user or data controller, you might collect personal data of others such as face, fingerprints, car plate number, Email address, phone number, GPS and so on. You need to be in compliance with the local privacy protection laws and regulations to protect the legitimate rights and interests of other people by implementing measures including but not limited to: providing clear and visible identification to inform data subject the existence of surveillance area and providing related contact.

About the Manual

- The manual is for reference only. If there is inconsistency between the manual and the actual product, the actual product shall prevail.
- We are not liable for any loss caused by the operations that do not comply with the manual.
- The manual would be updated according to the latest laws and regulations of related regions. For detailed information, see the paper manual, CD-ROM, QR code or our official website. If there is inconsistency between paper manual and the electronic version, the

electronic version shall prevail.

- All the designs and software are subject to change without prior written notice. The product updates might cause some differences between the actual product and the manual. Please contact the customer service for the latest program and supplementary documentation.
- There still might be deviation in technical data, functions and operations description, or errors in print. If there is any doubt or dispute, please refer to our final explanation.
- Upgrade the reader software or try other mainstream reader software if the manual (in PDF format) cannot be opened.
- All trademarks, registered trademarks and the company names in the manual are the properties of their respective owners.
- Please visit our website, contact the supplier or customer service if there is any problem occurred when using the device.
- If there is any uncertainty or controversy, please refer to our final explanation.

Important Safeguards and Warnings

The following description is the correct application method of the device. Read the manual carefully before use to prevent danger and property loss. Strictly conform to the manual during application and keep it properly after reading.

Operating Requirement

- Install the PoE front-end device indoors.
- The device does not support wall mount.
- Do not place and install the device in an area exposed to direct sunlight or near heat generating device.
- Do not install the device in a humid, dusty or fuliginous area.
- Keep its horizontal installation, or install it at stable places, and prevent it from falling.
- Do not drip or splash liquids onto the device; do not put on the device anything filled with liquids, in order to prevent liquids from flowing into the device.
- Install the device at well-ventilated places; do not block its ventilation opening.
- Use the device only within rated input and output range.
- Do not dismantle the device arbitrarily.
- Transport, use and store the device within allowed humidity and temperature range.

Power Requirement

- Use the designated battery type. Otherwise there may be explosion risk.
- Use batteries according to requirements. Otherwise, it may result in fire, explosion or burning risks of batteries!
- When replacing batteries, use the same type of batteries.
- Dispose the exhausted batteries according to the instructions.
- Use electric wires (power wires) recommended by this area and within its rated specification.
- Use standard power adapter matched with this device. Otherwise, the user shall undertake resulting personnel injuries or device damages.
- Use power supply that meets SELV (safety extra low voltage) requirements, and supply power with rated voltage that conforms to Limited Power Source in IEC60950-1. For specific power supply requirements, please refer to device labels.
- Products with category I structure shall be connected to grid power output socket, which is equipped with protective grounding.
- Appliance coupler is a disconnecting device. During normal use, please keep an angle that facilitates operation.

Table of Contents

Foreword	I
Important Safeguards and Warnings	IV
1 Features	1
1.1 Overview	1
1.2 Features	1
2 Front Panel and Rear Panel	4
2.1 Front Panel.....	4
2.1.1 NVR2 Series.....	4
2.1.1.1 NVR21-I Series	4
2.1.1.2 NVR22-I Series	4
2.1.1.3 NVR21-P-I Series	5
2.1.1.4 NVR22-P-I Series	5
2.1.1.5 NVR21-8P-I Series	6
2.1.1.6 NVR22-8P-I Series	6
2.1.1.7 NVR22-16P-I Series	6
2.1.1.8 NVR21HS-I Series	7
2.1.1.9 NVR21HS-P-I Series	8
2.1.1.10 NVR21HS-8P-I Series	8
2.1.1.11 NVR21H-4G-I Series	9
2.1.2 NVR5 Series.....	9
2.1.2.1 NVR58-I Series	9
2.1.2.2 NVR5432-16P-I/5216-16P-I/5216-8P-I Series	10
2.1.3 NVR6 Series.....	10
2.1.3.1 NVR608-4KS2 Series	10
2.1.3.2 NVR616-4KS2 Series	12
2.1.3.3 NVR624-4KS2Advanced 4U 24HDD AI NVR Series.....	14
2.2 Rear Panel.....	15
2.2.1 NVR2 Series.....	15
2.2.1.1 NVR21-I Series	15
2.2.1.2 NVR22-I Series	16
2.2.1.3 NVR21-P-I Series	17
2.2.1.4 NVR22-P-I Series	18
2.2.1.5 NVR21-8P-I Series	19
2.2.1.6 NVR22-8P-I Series	20
2.2.1.7 NVR22-16P-I Series	21
2.2.1.8 NVR21HS-I Series	23
2.2.1.9 NVR21HS-P-I Series	24

2.2.1.10 NVR21HS-8P-I Series	25
2.2.1.11 NVR21H-4G-I Series	26
2.2.2 NVR4 Series.....	27
2.2.2.1 NVR4208-8P-I Series	27
2.2.2.2 NVR4216-I Series	28
2.2.3 NVR5 Series.....	30
2.2.3.1 NVR58-I/4832-I Series.....	30
2.2.3.2 NVR54-16P-I/4416-16P-I/4432-IAdvanced 1.5U 4HDD 16PoE AI NVR/General 1.5U 4HDD 16PoE AI NVR/General 1.5U 4HDD AI NVR Series	32
2.2.3.3 NVR52-16P-I/52-8P-I/42-16P-I Series	34
2.2.4 NVR6 Series.....	36
2.2.4.1 NVR608-4KS2 Series	36
2.2.4.2 NVR616-4KS2 Series	37
2.2.4.3 NVR624-4KS2Advanced 4U 24HDD AI NVR Series.....	39
2.3 Alarm Connection	40
2.3.1 Alarm Port.....	40
2.3.2 Alarm Input Port.....	41
2.3.3 Alarm Output Port.....	42
2.3.4 Alarm Relay Specifications	42
2.4 Two-way Talk.....	43
2.4.1 Device-end to PC-end.....	43
2.4.2 PC-end to the Device-end	44
2.5 Mouse Operation.....	44
2.6 Remote Control	45
3 Device Installation.....	48
3.1 Device Installation Diagrams.....	48
3.2 Check Unpacked NVR	49
3.3 About Front Panel and Rear Panel.....	50
3.4 HDD Installation	50
3.4.1 NVR58-I/54-16P-I/4832-I/4416-16P-I/4432-I Series.....	50
3.4.2 NVR52-16P-I/52-8P-I/4216-16P-I/4208-8P-I/4216-I Series	54
3.5 CD-ROM Installation	56
3.6 Connection Sample.....	61
3.6.1 NVR58-I/4832-I Series	61
3.6.2 NVR54-16P-I/4416-16P-I/4432-I	62
3.6.3 NVR52-16P-I/52-8P-I/4216-16P-I/4208-8P-I/4216-I Series	62
4 Local Basic Operation	64
4.1 Getting Started	64
4.1.1 Booting up	64
4.1.2 Device Initialization	65

4.1.3 Resetting Password	69
4.1.3.1 Enabling Password Reset Function	69
4.1.3.2 Resetting Password on Local Interface	70
4.1.3.3 Reset Button	76
4.1.4 Quick Settings	77
4.1.4.1 General	78
4.1.4.1.1 General	78
4.1.4.1.2 Date and Time	80
4.1.4.1.3 Holiday	81
4.1.4.2 Basic Networking Settings	83
4.1.4.3 P2P	87
4.1.4.3.1 Local Operation	87
4.1.4.3.2 Client Operation	88
4.1.4.4 Adding Camera	90
4.1.4.5 RAID Manager	95
4.1.4.6 Schedule	96
4.1.4.6.1 Recording Schedule	97
4.1.4.6.2 Snapshot Schedule	103
4.1.4.6.3 Record Control	104
4.2 Camera	106
4.2.1 Connection	106
4.2.1.1 Changing IP address	106
4.2.1.2 Auto Changing H.265	108
4.2.1.3 IP Export	108
4.2.1.4 IP Import	109
4.2.2 Remote Device Initialization	110
4.2.3 Shortcut Menu to Add Camera	115
4.2.4 Image	116
4.2.5 Video Overlay	119
4.2.5.1 Overlay	119
4.2.5.2 Privacy Masking	119
4.2.6 Encode	120
4.2.6.1 Encode	121
4.2.6.2 Snapshot	123
4.2.7 Channel Name	125
4.2.8 Checking PoE Status	125
4.2.9 Remote Update	126
4.2.10 Remote Device Info	127
4.2.10.1 Device Status	127

4.2.10.2 Firmware.....	128
4.3 Live View	129
4.3.1 Live View.....	129
4.3.2 Navigation bar	130
4.3.2.1 Channel Info	131
4.3.2.2 USB Management	132
4.3.3 Live View Control Interface.....	133
4.3.3.1 Instant Replay	134
4.3.3.2 Digital Zoom	136
4.3.3.3 Instant Backup	137
4.3.3.4 Manual Snapshot	137
4.3.3.5 Two-way Talk	137
4.3.3.6 Switch Bit Streams	137
4.3.3.7 Shortcut Menu.....	138
4.3.3.8 Picture Search.....	138
4.3.4 Wireless Paring	140
4.3.5 Sequence	141
4.3.6 Fisheye (Optional).....	144
4.3.6.1 Fisheye De-warp on Live View Interface.....	144
4.3.6.2 Fisheye De-warp During Playback	147
4.3.7 Test Temperature.....	147
4.3.8 AI Live View Mode.....	148
4.3.9 Split Tracking	151
4.3.10 Quick Operation Bar	153
4.4 PTZ.....	155
4.4.1 PTZ Settings	156
4.4.2 PTZ Control	157
4.4.3 Configuring PTZ Functions	159
4.4.3.1 Configuring Presets	159
4.4.3.2 Configuring Tours	160
4.4.3.3 Configuring Patterns.....	161
4.4.3.4 Configuring AutoScan	161
4.4.4 Calling PTZ Functions	162
4.4.4.1 Calling Presets.....	162
4.4.4.2 Calling Tours.....	162
4.4.4.3 Calling Patterns	163
4.4.4.4 Calling AutoScan	163
4.4.4.5 Calling AutoPan	163
4.4.4.6 Using Auxiliary Button.....	163

4.5 Record File.....	164
4.6 Playback and Search	164
4.6.1 Instant Playback.....	164
4.6.2 Search Interface	164
4.6.2.1 Playback Control	167
4.6.2.2 Search Type	169
4.6.2.3 Clip	169
4.6.2.4 Record Backup	170
4.6.3 Smart Search Playback.....	170
4.6.4 Picture Search Playback.....	171
4.6.5 Tag Playback	172
4.6.6 Playback Image.....	174
4.6.7 Subperiod Playback	174
4.6.8 File List.....	175
4.6.9 Other Aux Functions	176
4.6.9.1 Digital Zoom.....	176
4.6.9.2 Switch Channel.....	176
4.7 AI.....	176
4.7.1 AI Search	176
4.7.1.1 Face Detection	177
4.7.1.2 Face Recognition.....	179
4.7.1.2.1 Searching by Attributes.....	180
4.7.1.2.2 Search by Image.....	181
4.7.1.3 IVS	183
4.7.1.4 Stereo Analysis.....	185
4.7.1.4.1 People Approach Detection	185
4.7.1.4.2 Fall Detection	185
4.7.1.4.3 People Exception Detection	186
4.7.1.4.4 People Retention Detection	186
4.7.1.5 Human Detection	187
4.7.1.6 Motor Vehicle Detection.....	188
4.7.1.7 Non-motor Vehicle Detection	189
4.7.1.8 People Counting	191
4.7.1.9 Heat map.....	192
4.7.1.9.1 General	192
4.7.1.9.2 Fisheye	193
4.7.1.10 SMD.....	193
4.7.1.11 Analytics List	194
4.7.2 Parameters	194

4.7.2.1 Smart Plan	194
4.7.2.2 Face Detection	197
4.7.2.3 Face Recognition.....	200
4.7.2.3.1 Configuring AI by Recorder	200
4.7.2.3.2 Configuring AI by Camera	202
4.7.2.4 IVS (General Behavior Analytics)	202
4.7.2.4.1 Tripwire.....	204
4.7.2.4.2 Intrusion	208
4.7.2.4.3 Abandoned Object Detection.....	210
4.7.2.4.4 Fast Moving.....	211
4.7.2.4.5 Crowd Gathering	213
4.7.2.4.6 Parking	215
4.7.2.4.7 Missing Object Detection	217
4.7.2.4.8 Loitering Detection.....	219
4.7.2.5 Video Metadata	221
4.7.2.6 Crowd Distribution	222
4.7.2.7 People Counting	224
4.7.2.7.1 People Counting.....	225
4.7.2.7.2 Queuing	227
4.7.2.8 Heat map.....	229
4.7.2.9 ANPR.....	231
4.7.2.10 SMD.....	233
4.7.2.11 Master-slave Tracking.....	236
4.7.2.12 Video Quality Analytics.....	239
4.7.3 Database	242
4.7.3.1 Creating Face Database.....	242
4.7.3.1.1 Adding Face Pictures.....	243
4.7.3.1.2 Adding One Face Picture	244
4.7.3.1.3 Adding Face Pictures in Batches	247
4.7.3.2 Exporting/Importing Face Database.....	248
4.7.3.2.1 Exporting Face Database	248
4.7.3.2.2 Importing Face Database	249
4.7.3.3 Block/Allow List.....	250
4.7.3.3.1 Adding B/W List.....	250
4.7.3.3.2 Deleting Black/White List	251
4.7.3.3.3 Import/Export Black/allowlist.....	251
4.8 Event Manager.....	252
4.8.1 Alarm Info	252
4.8.2 Alarm Status.....	253

4.8.3 Alarm Input	253
4.8.4 Alarm Control	256
4.8.5 Video Detection	257
4.8.5.1 Motion Detection	257
4.8.5.1.1 Setting the Motion Detection Region	259
4.8.5.1.2 Setting Schedule	260
4.8.5.2 Video Tampering	262
4.8.5.3 Video Loss	263
4.8.5.4 Scene Change	264
4.8.5.5 PIR Alarm	265
4.8.6 Audio Detection	266
4.8.7 Thermal Alarm	268
4.8.8 Exception	270
4.8.9 Disarming	274
4.9 POS	274
4.9.1 Search	275
4.9.2 Settings	276
4.9.2.1 Privacy Setup	277
4.9.2.2 Connection Mode	278
4.10 Operation and Maintenance	279
4.10.1 Log	279
4.10.2 System	280
4.10.2.1 System Version	280
4.10.2.2 AI Algorithm Version	280
4.10.2.3 HDD Info	280
4.10.2.4 BPS	281
4.10.2.5 Device Status	282
4.10.3 Network	283
4.10.3.1 Online User	283
4.10.3.2 Network Load	284
4.10.3.3 Network Test	285
4.10.4 Maintenance and Management	286
4.10.4.1 Device Maintenance	286
4.10.4.2 Exporting System Settings	287
4.10.4.3 Default	289
4.10.4.4 System Update	290
4.10.4.4.1 Upgrading File	290
4.10.4.4.2 Online Upgrade	292
4.10.4.4.3 Uboot Upgrading	293

4.11 Network	293
4.11.1 TCP/IP	293
4.11.2 Port	295
4.11.3 External Wi-Fi	296
4.11.4 Wi-Fi AP	298
4.11.4.1 General Settings	298
4.11.4.2 Advanced Settings	300
4.11.5 3G/4G	301
4.11.6 Cellular Network	302
4.11.7 Repeater	304
4.11.8 PPPoE	307
4.11.9 DDNS	308
4.11.10 UPnP	309
4.11.10.1 Configuring Router	309
4.11.10.2 Configuration UPnP	309
4.11.11 Email	311
4.11.12 SNMP	313
4.11.13 Multicast	315
4.11.14 Alarm Center	316
4.11.15 Register	317
4.11.16 Setting Switch	318
4.11.17 P2P	319
4.11.17.1 Mobile APP Operation	320
4.12 Storage	321
4.12.1 Basic	321
4.12.2 Schedule	322
4.12.3 Disk Manager	322
4.12.4 Record Control	323
4.12.5 Disk Group	323
4.12.6 Disk Quota	324
4.12.7 Disk Check	325
4.12.7.1 Manual Check	325
4.12.7.2 Detect Report	326
4.12.7.3 Disk Health Monitoring	328
4.12.8 RAID	329
4.12.8.1 Creating Manager	329
4.12.8.2 Raid Info	331
4.12.8.3 Hot Spare Disk	331
4.12.9 Record Estimate	333

4.12.9.1 Calculating Recording Time.....	334
4.12.9.2 Calculating HDD Capacity for Storage.....	335
4.12.10 FTP	335
4.12.11 Setting iSCSI	337
4.13 System.....	339
4.13.1 General.....	339
4.13.2 Serial Port.....	339
4.14 Security	340
4.14.1 Security Status.....	340
4.14.2 System Service	342
4.14.2.1 Basic Services	342
4.14.2.2 802.1x.....	344
4.14.2.3 HTTPS.....	345
4.14.3 Attack Defense	345
4.14.3.1 Firewall	345
4.14.3.2 Account Lockout	347
4.14.3.3 Anti-Dos Attack.....	347
4.14.3.4 Sync Time-Allowlist.....	348
4.14.4 CA Certificate	350
4.14.4.1 Device Certificate	350
4.14.4.2 Trusted CA Certificate.....	351
4.14.5 Audio/Video Encryption.....	352
4.14.6 Security Warning	354
4.14.6.1 Security Exception	354
4.14.6.2 Illegal Login.....	355
4.15 Account.....	356
4.15.1 User	356
4.15.1.1 Add User.....	356
4.15.1.2 Modify Password	358
4.15.2 Group	360
4.15.3 Reset Password	362
4.15.4 ONVIF User	363
4.16 Output and Display	364
4.16.1 Display	364
4.16.2 Tour	366
4.16.3 Custom Layout.....	367
4.17 Audio	370
4.17.1 File Management.....	370
4.17.2 Audio Play	372

4.17.3 Broadcast	373
4.18 USB Device Auto Pop-up	375
4.19 Shutdown	376
5 Web Operation	380
5.1 Network Connection	380
5.2 Web Login	380
5.3 Web Main Menu	381
5.4 Cluster Service	383
5.4.1 Cluster IP	383
5.4.2 Master Device	384
5.4.3 Slave Device	386
5.4.4 Transfer Record	386
5.4.5 Cluster Control	387
5.4.5.1 Cluster Control	387
5.4.5.2 Arbitrage IP	387
5.4.6 Cluster Log	388
6 Glossary	389
7 FAQ	390
Appendix 1 Cybersecurity Recommendations	394
Appendix 2 HDD Capacity Calculation	397
Appendix 3 Compatible Network Camera List	398

1 Features

1.1 Overview

This series NVR is a high performance network video recorder. This series product supports local live view, multiple-window display, recorded file local storage, remote control and mouse shortcut menu operation, and remote management and control function.

This series product supports center storage, front-end storage and client-end storage. The monitor zone in the front-end can be set in anywhere. Working with other front-end devices such as IPC, NVS, this series product can establish a strong surveillance network through the CMS. In the network system, there is only one network cable from the monitor center to the monitor zone in the whole network. There is no audio/video cable from the monitor center to the monitor zone. The whole project is featured by simple connection, low-cost, low maintenance work.

This series NVR can be widely used in areas such as public security, water conservancy, transportation and education.

1.2 Features

AI Functions



AI functions vary model to model. The actual product shall prevail.

- Different models have different AI functions. The actual product shall prevail.
- Face detection. It includes front-end smart detection and back-end smart detection.
- Face recognition. It enables users to compare the detected faces with the images in the face database in real time.
- Human body detection. System activates alarm actions once human body is detected.
- People counting. It can effectively count the number of people and flow direction.
- Heat map. It can monitor the active objects in a specific area.
- Automatic number plate recognition (ANPR). It can effectively monitor the passing vehicles.

Smart Playback

- IVS playback. It can screen out and replay the records meeting the set rules.
- Face detection playback. It can screen out and replay the records with human faces.
- Face recognition playback. It can compare the face information in the video with the information in the database and replay the corresponding records.
- ANPR playback. It can screen out the record with a specific car plate number or all the records with car plate numbers.
- Human body detection playback. It can screen out and replay the records with specific human bodies.
- Smart search. It includes smart functions such as searching by attribute and searching by

image to enable users to get target records quickly.

Cloud Upgrade

For the NVR connected to the Internet, it supports application online upgrade.

Real-Time Surveillance

- VGA, HDMI port. Connect to monitor to realize real-time surveillance. Some series support TV/VGA/HDMI output at the same time.
- Shortcut menu for preview.
- Support multiple popular PTZ decoder control protocols. Support preset, tour and pattern.

Playback

- Support independent real-time recording for each channel. At the same time it supports functions such as smart search, forward play, network monitor, record search and download.
- Support various playback modes: slow play, fast play, backward play and frame-by-frame play.
- Support time title overlay so that you can view the event accurate occurred time.
- Support specified zone enlargement.

User Management

Users can be added to user groups for management. Each group has a set of permissions that can be individually edited.

Storage

- With corresponding settings (such as alarm settings and schedule settings), you can back up related audio/video data in the network video recorder.
- You can take records via the web and the record files are saved on the PC in which the client locates.

Alarm

- Respond to external alarm simultaneously (within 200 ms). Based on user's pre-defined relay settings, the system can process the alarm input correctly and sends user screen or voice prompts (supporting pre-recorded audio).
- Support settings of the central alarm server, so that the system can automatically notify users of the alarm information. Alarm input can be derived from various connected peripheral devices.
- Alert you of alarm information via email.

Network Surveillance

- Send audio/video data compressed by IPC or NVS to client-ends through the network, and then the data will be decompressed and displayed.
- Support max 128 connections at the same time.
- Transmit audio/video data by protocols such as HTTP, TCP, UDP, MULTICAST and RTP/RTCP.
- Transmit some alarm data or alarm info by SNMP.
- Support web access in WAN/LAN.

Window Split

Adopt video compression and digital processing to display several windows in one monitor. Support 1/4/8/9/16/25/36 window split in preview and 1/4/9/16 window split in playback.

Record

Support regular record, motion record, alarm record and smart record. Save the recorded files in the HDD, USB device, client-end PC or network storage server and you can search or playback the saved files at the local-end or via the Web/USB devices.

Backup

Support network backup and USB record backup. You can back up the record files in devices such as network storage server, peripheral USB2.0 device and burner.

Network Management

- Supervise NVR configuration and control power via Ethernet.
- Support web management.

Peripheral Equipment Management

- Support peripheral device control and you can freely set the control protocol and connection port.
- Support transparent data transmission such as RS-232 and RS-485.

Auxiliary

- Support switch between NTSC and PAL.
- Support real-time display of system resources information and running status.
- Support log record.
- Local GUI output. Shortcut menu operation with the mouse.
- IR control function (for some series only). Shortcut menu operation with remote control.
- Support to play the video/audio files from remote IPC or NVS.



For description of other functions, see the following contents.

2 Front Panel and Rear Panel



The following front panel and rear panel figures are for reference only. The actual product shall prevail.

2.1 Front Panel

2.1.1 NVR2 Series

2.1.1.1 NVR21-I Series

The front panel is shown as below.



The figure is for reference only. The actual product shall prevail.

Figure 2-1

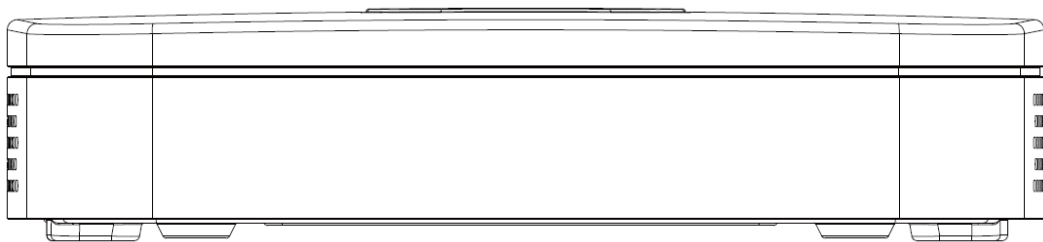

2.1.1.2 NVR22-I Series

The front panel is shown as below.



The figure is for reference only. The actual product shall prevail.

Figure 2-2



Table 2-1

Icon	Name	Function
HDD	HDD status indicator light	The light is on when the HDD is malfunction.

Icon	Name	Function
NET	Network status indicator light	The light is on when the network connection is abnormal.
POWER	Power status indicator light	The light is on when the power connection is OK.
	USB 2.0 port	Connect to peripheral USB 2.0 storage device, mouse, burner and etc.

2.1.1.3 NVR21-P-I Series

The front panel is shown as below.



The figure is for reference only. The actual product shall prevail.

Figure 2-3

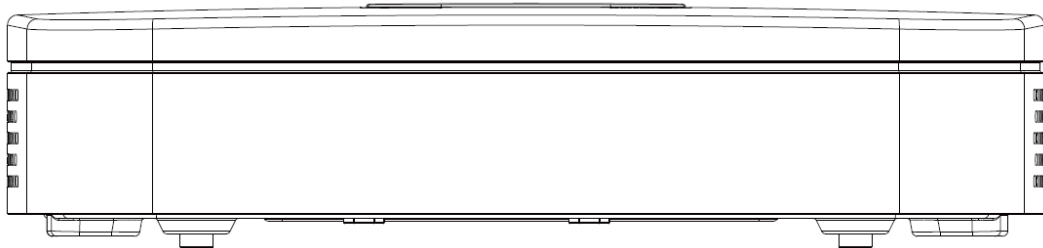

2.1.1.4 NVR22-P-I Series

The front panel is shown as below.



The figure is for reference only. The actual product shall prevail.

Figure 2-4

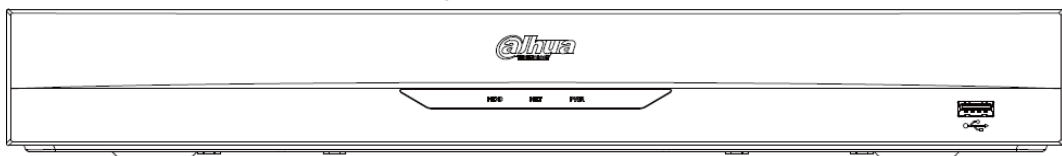



Table 2-2

Icon	Name	Function
HDD	HDD status indicator light	The blue light is on when the HDD malfunctions.
NET	Network status indicator light	The blue light is on when the network connection is abnormal.
POWER	Power status indicator light	The blue light is on when the power connection is OK.
	USB 2.0 port	Connect to peripheral USB 2.0 storage device, mouse, burner and more.

2.1.1.5 NVR21-8P-I Series

The front panel is shown as below.



The figure is for reference only. The actual product shall prevail.

Figure 2-5

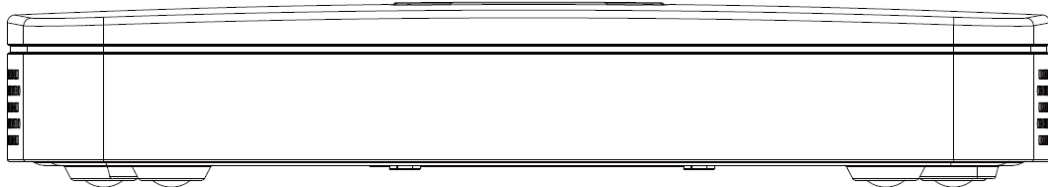

2.1.1.6 NVR22-8P-I Series

The front panel is shown as below.



The figure is for reference only. The actual product shall prevail.

Figure 2-6

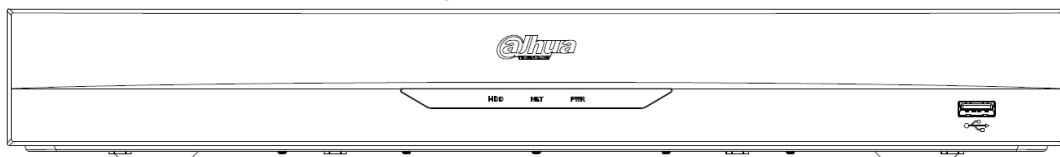



Table 2-3

Icon	Name	Function
HDD	HDD status indicator light	The blue light is on when the HDD malfunctions.
NET	Network status indicator light	The blue light is on when the network connection is abnormal.
POWER	Power status indicator light	The blue light is on when the power connection is OK.
	USB 2.0 port	Connect to peripheral USB 2.0 storage device, mouse, burner and more.

2.1.1.7 NVR22-16P-I Series

The front panel is shown as below.



The figure is for reference only. The actual product shall prevail.

Figure 2-7



Table 2-4

Icon	Name	Function
HDD	HDD status indicator light	The blue light is on when the HDD malfunctions.
NET	Network status indicator light	The blue light is on when the network connection is abnormal.
POWER	Power status indicator light	The blue light is on when the power connection is OK.
	USB 2.0 port	Connect to peripheral USB 2.0 storage device, mouse, burner and more.

2.1.1.8 NVR21HS-I Series

The front panel is shown as below.



The figure is for reference only. The actual product shall prevail.

Figure 2-8

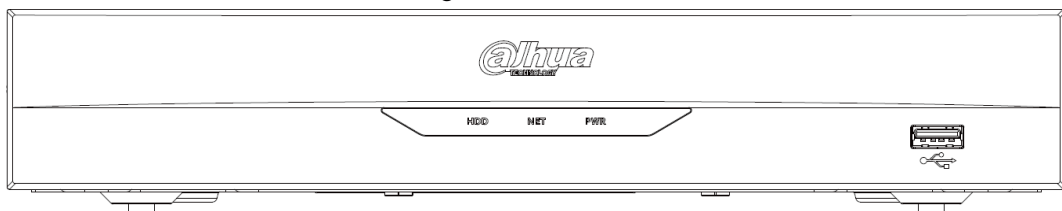



Table 2-5

Icon	Name	Function
HDD	HDD status indicator light	The blue light is on when the HDD malfunctions.
NET	Network status indicator light	The blue light is on when the network connection is abnormal.
POWER	Power status indicator light	The blue light is on when the power connection is OK.
	USB 2.0 port	Connect to peripheral USB 2.0 storage device, mouse, burner and more.

2.1.1.9 NVR21HS-P-I Series

The front panel is shown as below.



The figure is for reference only. The actual product shall prevail.

Figure 2-9

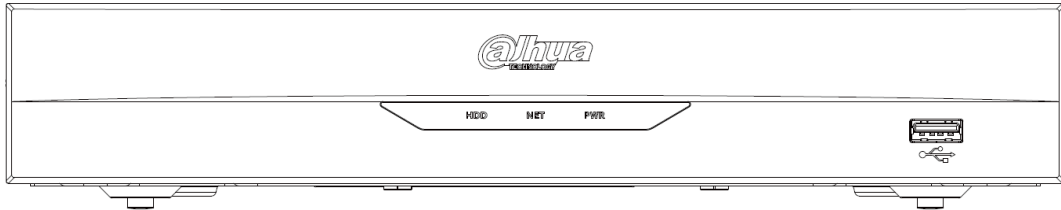



Table 2-6

Icon	Name	Function
HDD	HDD status indicator light	The blue light is on when the HDD malfunctions.
NET	Network status indicator light	The blue light is on when the network connection is abnormal.
POWER	Power status indicator light	The blue light is on when the power connection is OK.
	USB 2.0 port	Connect to peripheral USB 2.0 storage device, mouse, burner and more.

2.1.1.10 NVR21HS-8P-I Series

The front panel is shown as below.



The figure is for reference only. The actual product shall prevail.

Figure 2-10

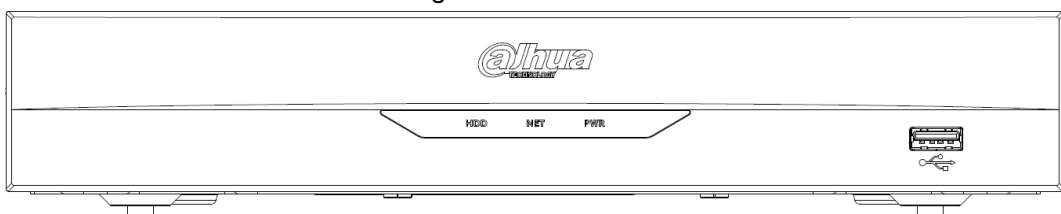

Table 2-7

Icon	Name	Function
HDD	HDD status indicator light	The blue light is on when the HDD malfunctions.
NET	Network status indicator light	The blue light is on when the network connection is abnormal.
POWER	Power status indicator light	The blue light is on when the power connection is OK.

Icon	Name	Function
	USB 2.0 port	Connect to peripheral USB 2.0 storage device, mouse, burner and more.

2.1.1.11 NVR21H-4G-I Series

The front panel is shown as below.



The figure is for reference only. The actual product shall prevail.

Figure 2-11

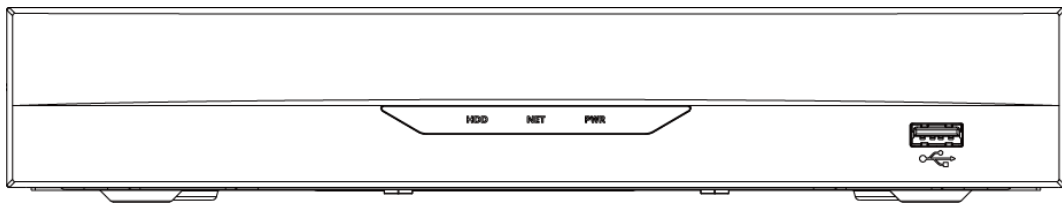

Table 2-8

Icon	Name	Function
HDD	HDD status indicator light	The blue light is on when the HDD malfunctions.
NET	Network status indicator light	The blue light is on when the network connection is abnormal.
POWER	Power status indicator light	The blue light is on when the power connection is OK.
	USB 2.0 port	Connect to peripheral USB 2.0 storage device, mouse, burner and more.

2.1.2 NVR5 Series

2.1.2.1 NVR58-I Series

Figure 2-12 takes NVR5864-I and NVR5832-I series as examples.



The figure is for reference only. The actual product shall prevail.

Figure 2-12

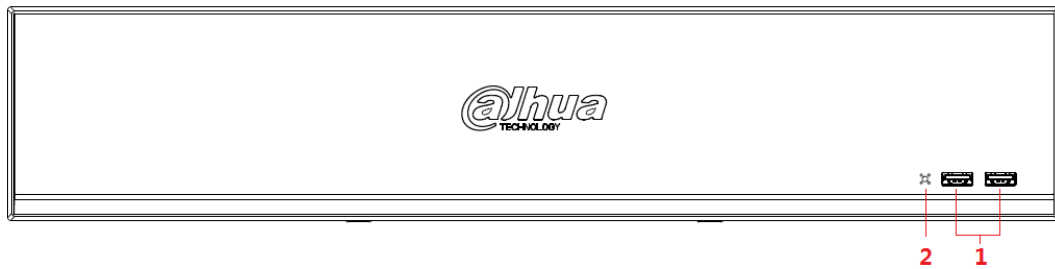

Table 2-9

No.	Port Name	Function
1	USB port	Connects to the external devices such as keyboard, mouse, and USB storage device.
2	IR indicator	Receive signals from the remote control.

2.1.2.2 NVR5432-16P-I/5216-16P-I/5216-8P-I Series

Figure 2-13 takes NVR5432-16P-I/5216-16P-I/5216-8P-I series as examples.



The figure is for reference only. The actual product shall prevail.

Figure 2-13

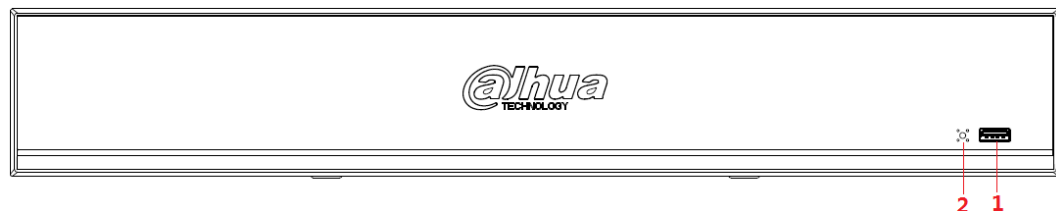

Table 2-10

No.	Port Name	Function
1	USB port	Connects to the external devices such as keyboard, mouse, and USB storage device.
2	IR indicator	Receive signals from the remote control.

2.1.3 NVR6 Series

2.1.3.1 NVR608-4KS2 Series



The following figures are for reference only. The actual product shall prevail.

The NVR608-32-4KS2 front panel is shown as below.

Figure 2-14

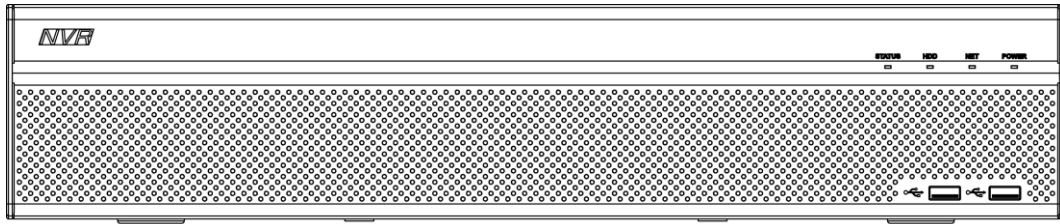

Table 2-11

Icon	Name	Function
STATUS	Status indicator light	The blue light is on when the device is working properly.
HDD	HDD status indicator light	The blue light is on when the HDD is malfunction.
NET	Network status indicator light	The blue light is on when the network connection is abnormal.
POWER	Power status indicator light	The blue light is on when the power connection is OK.
	USB 2.0 port	Connect to peripheral USB 2.0 storage device, mouse, burner and etc.

The NVR608-64-4KS2, NVR608-128-4KS2 front panel is shown as below.

Figure 2-15

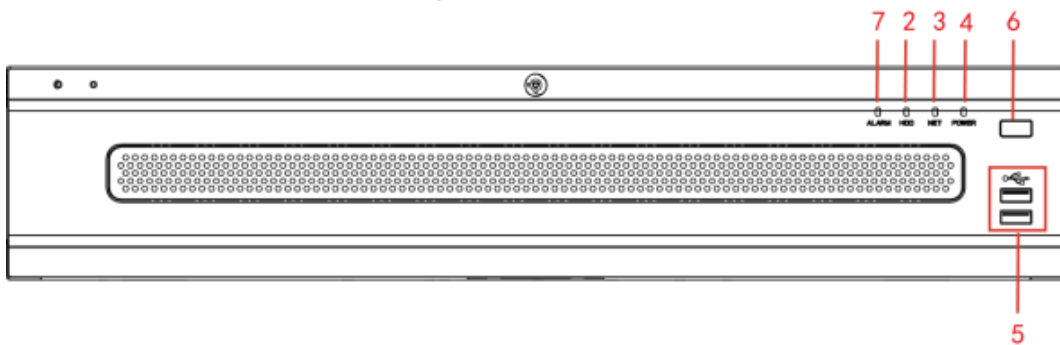

Table 2-12

SN	Icon	Name
1	STATUS	Status indicator light
2	HDD	HDD status indicator light
3	NET	Network status indicator light
4	POWER	Power status indicator light
5		USB 2.0 port
6		Power on-off button
7	ALARM	Alarm indicator light

2.1.3.2 NVR616-4KS2 Series



The following figures are for reference only. The actual product shall prevail.
For the product of LCD, the front panel of NVR616-4KS2 is shown as below.

Figure 2-16

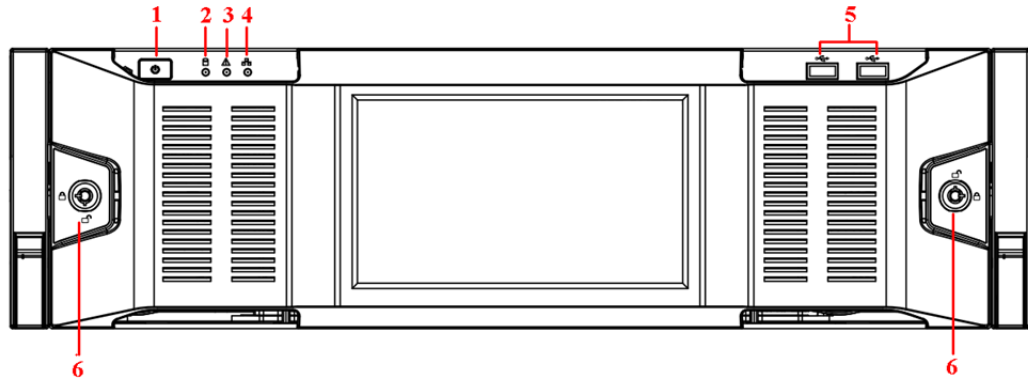

Table 2-13

SN	Name	Function
1	Power button	Press it once to turn on the device. Press it for a long time to turn off the device. (Usually we do not recommend). Press power button for a long time or pull out the power cable may result in device auto restart.
2	System HDD Indicator light	The blue light becomes on after system booted up properly. In the system HDD, there are device important configuration file, factory default configuration file, and device initial boot up data.
3	Alarm indicator light	The alarm indicator light becomes on once an alarm occurred. It becomes on via the software detection. The indicator light becomes on when there is a local alarm.
4	Network indicator light	The blue network indicator light is on after you connected the device to the network.
5	USB port	/
6	Front panel lock	/

For general NVR616-4KS2 series, the front panel is shown as below.

Figure 2-17

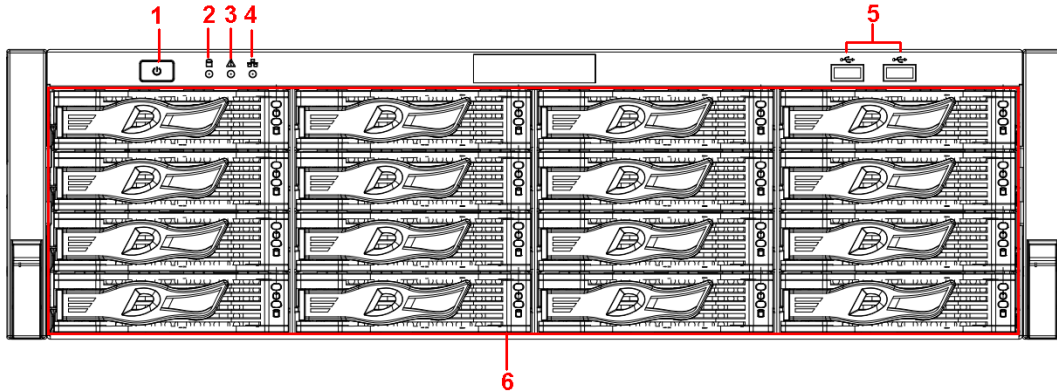

Table 2-14

SN	Name	Function
1	Power button	Press it once to turn on the device. Press it for a long time to turn off the device (Usually we do not recommend). Press power button for a long time or pull out the power cable may result in device auto restart.
2	System HDD Indicator light	The blue light becomes on after system booted up properly. In the system HDD, there are device important configuration file, factory default configuration file, device initial boot up data.
3	Alarm indicator light	The alarm indicator light becomes on once an alarm occurred. It becomes on via the software detection. The indicator light becomes on when there is a local alarm.
4	Network indicator light	The blue network indicator light is on after you connected the device to the network.
5	USB port	/
6	16 HDD slot	/

After you remove the front panel, you can see there are 16 HDDs. From the left to the right and from the top to the bottom, it ranges from 1~4, 5~8, 9~12, 13~16.

You can see there are two indicator lights on the HDD bracket.

- The power indicator light is at the top. The light is yellow after you connected the device to the power.
- The read-write indicator light is at the bottom. The blue light flashes when system is reading or writing the data.

Figure 2-18

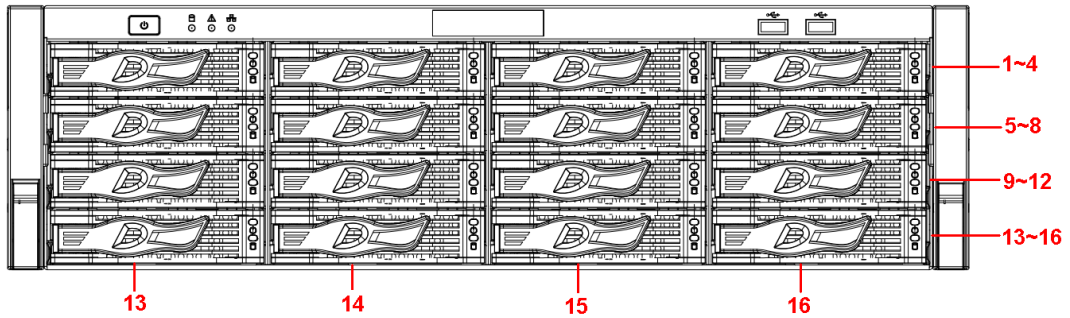

2.1.3.3 NVR624-4KS2Advanced 4U 24HDD AI NVR Series



The following figures are for reference only. The actual product shall prevail.

For the product with LCD, the front panel of NVR624-4KS2Advanced 4U 24HDD AI NVR is shown as below.

Figure 2-19

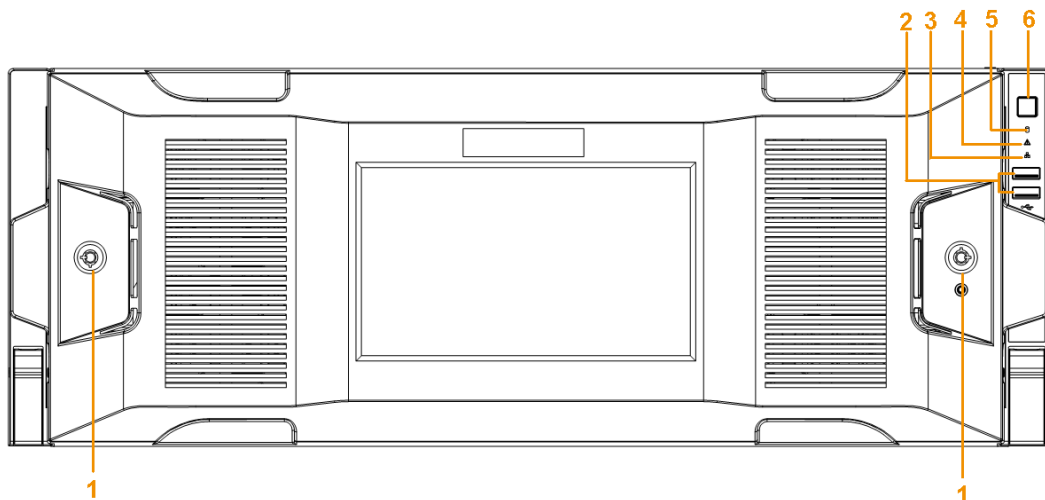



Table 2-15

No.	Icon	Name	Function
1		Front panel lock	Lock the front panel.
2		USB 2.0 port	Connect to peripheral USB 2.0 storage device, mouse, burner and etc.
3		Network status indicator light	The blue light is on when the network connection is abnormal.
4		Alarm indicator light	The alarm indicator light becomes on once an alarm occurred. It becomes on via the software detection. The indicator light becomes on when there is a local alarm.
5		HDD status indicator light	The blue light is on when the HDD is malfunction.

No.	Icon	Name	Function
6		Power button	Press it once to turn on the device. Press it for a long time to turn off the device. (Usually we do not recommend). Press power button for a long time or pull out the power cable may result in device auto restart.

After you remove the front panel, you can see there are 24 HDDs. From the left to the right and from the top to the bottom, it ranges from 1~4, 5~8, 9~12, 13~16, 17~20, 21~24.

You can see there are two indicator lights on the HDD bracket.

- The power indicator light is at the top. The light is yellow after you connected the device to the power.
- The read-write indicator light is at the bottom. The blue light flashes when system is reading or writing the data.

Figure 2-20

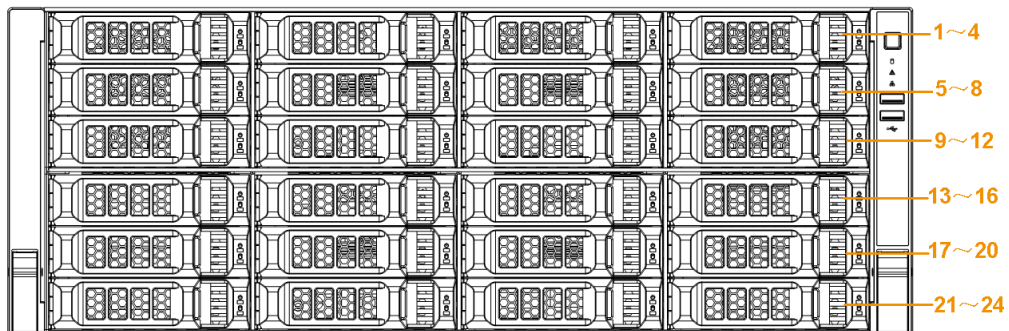

2.2 Rear Panel

2.2.1 NVR2 Series

2.2.1.1 NVR21-I Series

The rear panel is shown as below.



The figure is for reference only. The actual product shall prevail.

Figure 2-21

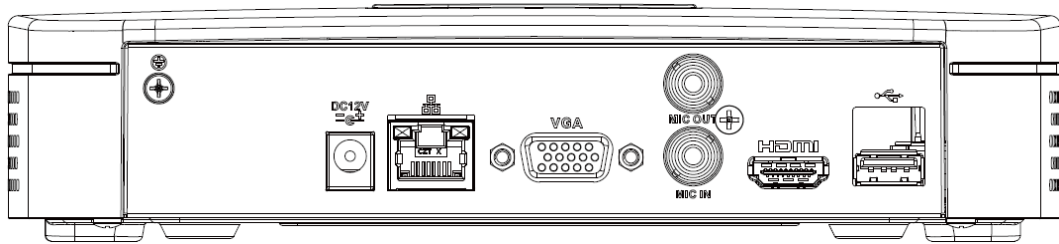

Table 2-16

Port Name	Connection	Function
	USB port	USB port. Connect to mouse, USB storage device and etc.
HDMI	High Definition Media Interface	High definition audio and video signal output port. It transmits uncompressed high definition video and multiple-channel data to the HDMI port of the display device. HDMI version is 1.4.
MIC IN	Audio input port	Bidirectional talk input port. It is to receive the analog audio signal output from the devices such as microphone, pickup.
MIC OUT	Audio output port	Audio output port. It is to output the analog audio signal to the devices such as the sound box. <ul style="list-style-type: none"> • Bidirectional talk output. • Audio output on 1-window video monitor. • Audio output on 1-window video playback.
VGA	VGA video output port	VGA video output port. Output analog video signal. It can connect to the monitor to view analog video.
	Network port	10M/100Mbps self-adaptive Ethernet port. Connect to the network cable.
	Power input port	Power socket.
	GND	Ground end

2.2.1.2 NVR22-I Series

The rear panel is shown as below.



The figure is for reference only. The actual product shall prevail.

Figure 2-22

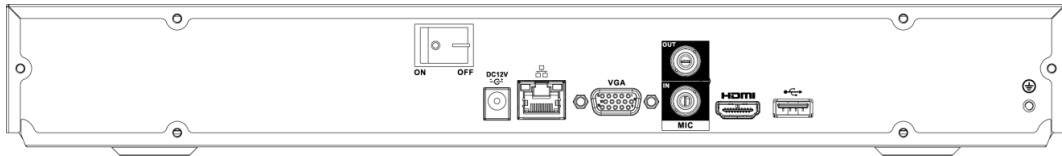

Table 2-17

Port Name	Connection	Function
⊕	GND	Ground end
	USB port	USB port. Connect to mouse, USB storage device and etc.
HDMI	High Definition Media Interface	High definition audio and video signal output port. It transmits uncompressed high definition video and multiple-channel data to the HDMI port of the display device. HDMI version is 1.4.
MIC IN	Audio input port	Bidirectional talk input port. It is to receive the analog audio signal output from the devices such as microphone, pickup.
MIC OUT	Audio output port	Audio output port. It is to output the analog audio signal to the devices such as the sound box. <ul style="list-style-type: none"> • Bidirectional talk output. • Audio output on 1-window video monitor. • Audio output on 1-window video playback.
VGA	VGA video output port	VGA video output port. Output analog video signal. It can connect to the monitor to view analog video.
	Network port	10M/100Mbps self-adaptive Ethernet port. Connect to the network cable.
DC 12V 	Power input port	Power socket.
	Power switch	Power on/off button.

2.2.1.3 NVR21-P-I Series

The rear panel is shown as below.



The figure is for reference only. The actual product shall prevail.

Figure 2-23

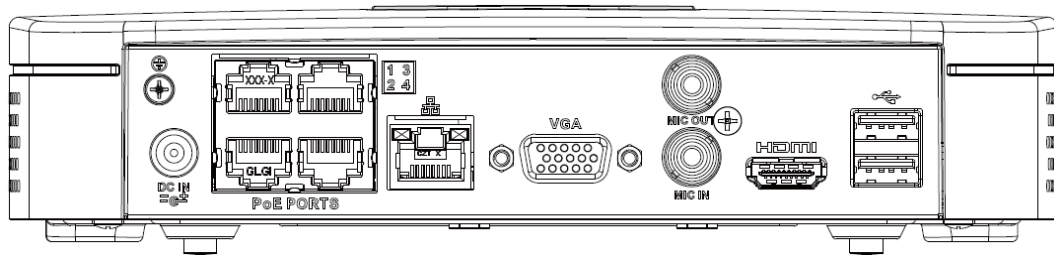

Table 2-18

Port Name	Connection	Function
	USB port	USB port. Connect to mouse, USB storage device and etc.
HDMI	High Definition Media Interface	High definition audio and video signal output port. It transmits uncompressed high definition video and multiple-channel data to the HDMI port of the display device. HDMI version is 1.4.
MIC IN	Audio input port	Bidirectional talk input port. It is to receive the analog audio signal output from the devices such as microphone, pickup.
MIC OUT	Audio output port	Audio output port. It is to output the analog audio signal to the devices such as the sound box. <ul style="list-style-type: none"> • Bidirectional talk output. • Audio output on 1-window video monitor. • Audio output on 1-window video playback.
VGA	VGA video output port	VGA video output port. Output analog video signal. It can connect to the monitor to view analog video.
	Network port	10M/100Mbps self-adaptive Ethernet port. Connect to the network cable.
PoE PORTS	PoE port	Built-in switch. Support PoE function. For PoE series product, you can use this port to provide power to the network camera.
	Power input port	Power socket.
	GND	Ground end

2.2.1.4 NVR22-P-I Series

The rear panel is shown as below.



The figure is for reference only. The actual product shall prevail.

Figure 2-24

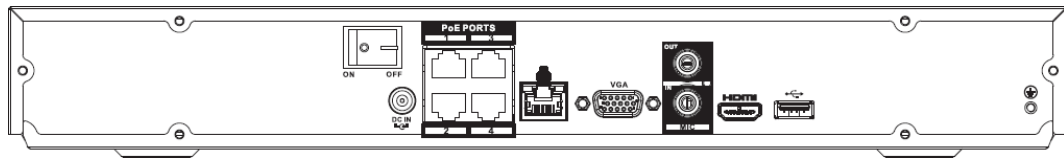

Table 2-19

Port Name	Connection	Function
	GND	Ground end
	USB port	USB port. Connect to mouse, USB storage device and etc.
HDMI	High Definition Media Interface	High definition audio and video signal output port. It transmits uncompressed high definition video and multiple-channel data to the HDMI port of the display device. HDMI version is 1.4.
MIC IN	Audio input port	Bidirectional talk input port. It is to receive the analog audio signal output from the devices such as microphone, pickup.
MIC OUT	Audio output port	Audio output port. It is to output the analog audio signal to the devices such as the sound box. <ul style="list-style-type: none"> • Bidirectional talk output. • Audio output on 1-window video monitor. • Audio output on 1-window video playback.
VGA	VGA video output port	VGA video output port. Output analog video signal. It can connect to the monitor to view analog video.
	Network port	10M/100Mbps self-adaptive Ethernet port. Connect to the network cable.
PoE PORTS	PoE port	Built-in switch. Support PoE function. For PoE series product, you can use this port to provide power to the network camera.
	Power input port	Power socket.
	Power switch	Power on/off button.

2.2.1.5 NVR21-8P-I Series

The rear panel is shown as below.



The figure is for reference only. The actual product shall prevail.

Figure 2-25

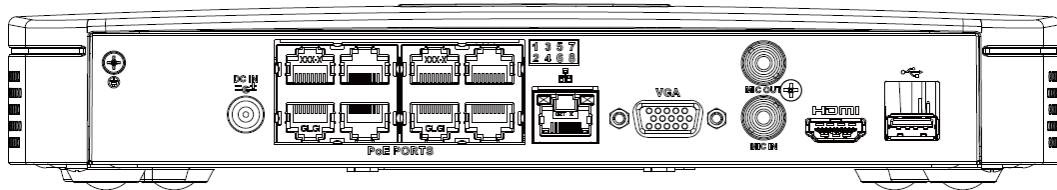

Table 2-20

Port Name	Connection	Function
	USB port	USB port. Connect to mouse, USB storage device and etc.
HDMI	High Definition Media Interface	High definition audio and video signal output port. It transmits uncompressed high definition video and multiple-channel data to the HDMI port of the display device. HDMI version is 1.4.
MIC IN	Audio input port	Bidirectional talk input port. It is to receive the analog audio signal output from the devices such as microphone, pickup.
MIC OUT	Audio output port	Audio output port. It is to output the analog audio signal to the devices such as the sound box. <ul style="list-style-type: none"> • Bidirectional talk output. • Audio output on 1-window video monitor. • Audio output on 1-window video playback.
VGA	VGA video output port	VGA video output port. Output analog video signal. It can connect to the monitor to view analog video.
	Network port	10M/100Mbps self-adaptive Ethernet port. Connect to the network cable.
PoE PORTS	PoE port	Built-in switch. Support PoE function. For PoE series product, you can use this port to provide power to the network camera.
	Power input port	Power socket.
	GND	Ground end

2.2.1.6 NVR22-8P-I Series

The rear panel is shown as below.



The figure is for reference only. The actual product shall prevail.

Figure 2-26

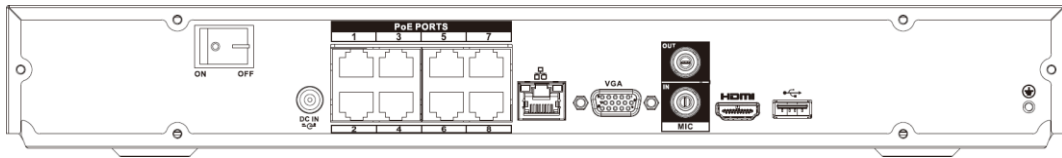

Table 2-21

Port Name	Connection	Function
	GND	Ground end
	USB port	USB port. Connect to mouse, USB storage device and etc.
HDMI	High Definition Media Interface	High definition audio and video signal output port. It transmits uncompressed high definition video and multiple-channel data to the HDMI port of the display device. HDMI version is 1.4.
MIC IN	Audio input port	Bidirectional talk input port. It is to receive the analog audio signal output from the devices such as microphone, pickup.
MIC OUT	Audio output port	Audio output port. It is to output the analog audio signal to the devices such as the sound box. <ul style="list-style-type: none"> • Bidirectional talk output. • Audio output on 1-window video monitor. • Audio output on 1-window video playback.
VGA	VGA video output port	VGA video output port. Output analog video signal. It can connect to the monitor to view analog video.
	Network port	10M/100Mbps self-adaptive Ethernet port. Connect to the network cable.
PoE PORTS	PoE port	Built-in switch. Support PoE function. For PoE series product, you can use this port to provide power to the network camera.
	Power input port	Power socket.
	Power switch	Power on/off button.

2.2.1.7 NVR22-16P-I Series

The rear panel is shown as below.



The figure is for reference only. The actual product shall prevail.

Figure 2-27

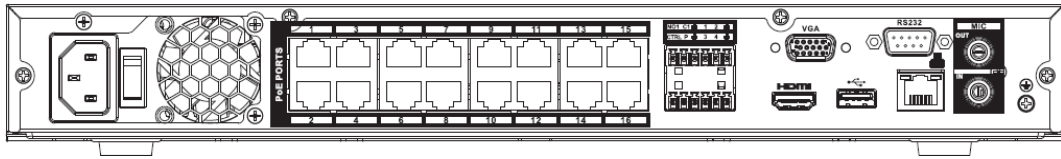
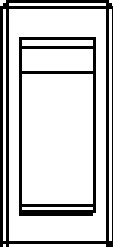
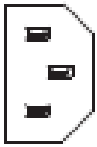

Table 2-22

Port Name	Connection	Function
⊕	GND	Ground end
MIC IN	Audio input port	Bidirectional talk input port. It is to receive the analog audio signal output from the devices such as microphone, pickup.
MIC OUT	Audio output port	Audio output port. It is to output the analog audio signal to the devices such as the sound box. <ul style="list-style-type: none"> • Bidirectional talk output. • Audio output on 1-window video monitor. • Audio output on 1-window video playback.
RS232	RS232 debug COM	It is for general COM debug to configure IP address or transfer transparent COM data.
	Network port	10M/100Mbps self-adaptive Ethernet port. Connect to the network cable.
	USB port	USB port. Connect to mouse, USB storage device and etc.
VGA	VGA video output port	VGA video output port. Output analog video signal. It can connect to the monitor to view analog video.
HDMI	High Definition Media Interface	High definition audio and video signal output port. It transmits uncompressed high definition video and multiple-channel data to the HDMI port of the display device. HDMI version is 1.4.
NO1	Alarm output port	<ul style="list-style-type: none"> • 1 group of alarm output ports. (port NO1–C1).Output alarm signal to the alarm device. Please make sure there is power to the external alarm device. • NO: Normal open alarm output port. • C: Alarm output public end.
C1		
CTRL	/	Controllable power supply output. Control the output of the on-off button alarm relay. It controls the alarm device with the presence or absence of voltage. It can also be used as power input for some alarm devices such as alarm detectors.

Port Name	Connection	Function
P	/	Power output port. It can provide power to some peripheral devices such as camera and alarm device. Make sure the power supply of peripheral device shall be below 1A.
PoE PORTS	PoE port	Built-in switch. Support PoE function. For PoE series product, you can use this port to provide power to the network camera.
	Power switch	Power on/off button.
	Power input port	Power socket.

2.2.1.8 NVR21HS-I Series

The rear panel is shown as below.



The figure is for reference only. The actual product shall prevail.

Figure 2-28

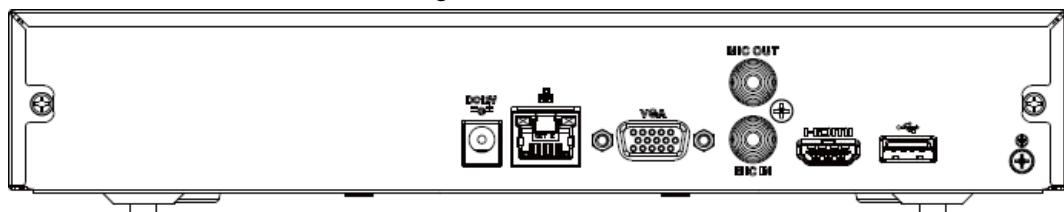





Table 2-23

Port Name	Connection	Function
	GND	Ground end
	USB port	USB port. Connect to mouse, USB storage device and etc.
HDMI	High Definition Media Interface	High definition audio and video signal output port. It transmits uncompressed high definition video and multiple-channel data to the HDMI port of the display device. HDMI version is 1.4.
MIC IN	Audio input port	Bidirectional talk input port. It is to receive the analog audio signal output from the devices such as microphone, pickup.

Port Name	Connection	Function
MIC OUT	Audio output port	Audio output port. It is to output the analog audio signal to the devices such as the sound box. <ul style="list-style-type: none"> • Bidirectional talk output. • Audio output on 1-window video monitor. • Audio output on 1-window video playback.
VGA	VGA video output port	VGA video output port. Output analog video signal. It can connect to the monitor to view analog video.
	Network port	10M/100Mbps self-adaptive Ethernet port. Connect to the network cable.
PoE PORTS	PoE port	Built-in switch. Support PoE function. For PoE series product, you can use this port to provide power to the network camera.
	Power input port	Power socket.

2.2.1.9 NVR21HS-P-I Series

The rear panel is shown as below.



The figure is for reference only. The actual product shall prevail.

Figure 2-29

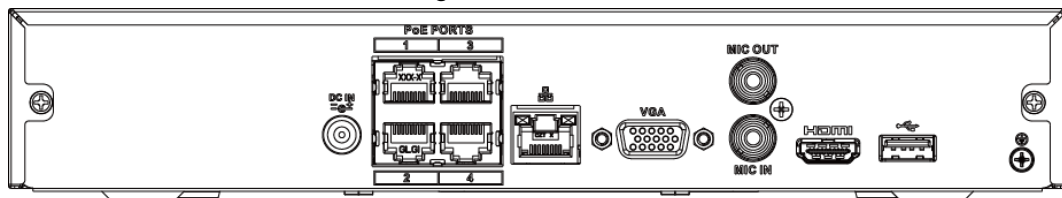





Table 2-24

Port Name	Connection	Function
	Power input port	Power socket
	Network port	10M/100Mbps self-adaptive Ethernet port. Connect to the network cable.
	USB port	USB port. Connect to mouse, USB storage device and etc.
HDMI	High Definition Media Interface	High definition audio and video signal output port. It transmits uncompressed high definition video and multiple-channel data to the HDMI port of the display device. HDMI version is 1.4.
VGA	VGA video output port	VGA video output port. Output analog video signal. It can connect to the monitor to view analog video.

Port Name	Connection	Function
MIC IN	Audio input port	Bidirectional talk input port. It is to receive the analog audio signal output from the devices such as microphone, pickup.
MIC OUT	Audio output port	Audio output port. It is to output the analog audio signal to the devices such as the sound box. <ul style="list-style-type: none"> • Bidirectional talk output. • Audio output on 1-window video monitor. • Audio output on 1-window video playback.
⊕	GND	Ground end
PoE PORTS	PoE port	Built-in switch. Support PoE function. For PoE series product, you can use this port to provide power to the network camera.

2.2.1.10 NVR21HS-8P-I Series

The rear panel is shown as below.



The figure is for reference only. The actual product shall prevail.

Figure 2-30

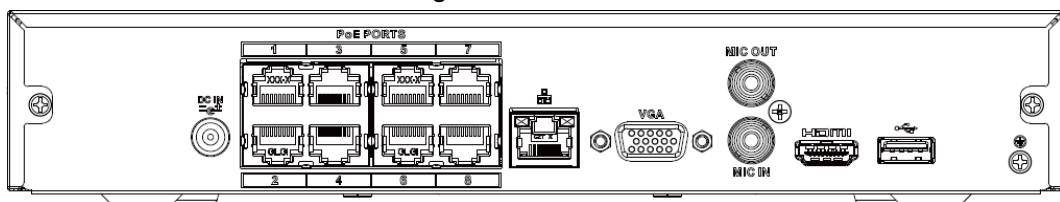



Table 2-25

Port Name	Connection	Function
⊕	GND	Ground end
USB	USB port	USB port. Connect to mouse, USB storage device and etc.
HDMI	High Definition Media Interface	High definition audio and video signal output port. It transmits uncompressed high definition video and multiple-channel data to the HDMI port of the display device. HDMI version is 1.4.
MIC IN	Audio input port	Bidirectional talk input port. It is to receive the analog audio signal output from the devices such as microphone, pickup.
MIC OUT	Audio output port	Audio output port. It is to output the analog audio signal to the devices such as the sound box. <ul style="list-style-type: none"> • Bidirectional talk output. • Audio output on 1-window video monitor. • Audio output on 1-window video playback.

Port Name	Connection	Function
VGA	VGA video output port	VGA video output port. Output analog video signal. It can connect to the monitor to view analog video.
	Network port	10M/100Mbps self-adaptive Ethernet port. Connect to the network cable.
PoE PORTS	PoE port	Built-in switch. Support PoE function. For PoE series product, you can use this port to provide power to the network camera.
	Power input port	Power socket.

2.2.1.11 NVR21H-4G-I Series

The rear panel is shown as below.



The figure is for reference only. The actual product shall prevail.

Figure 2-31

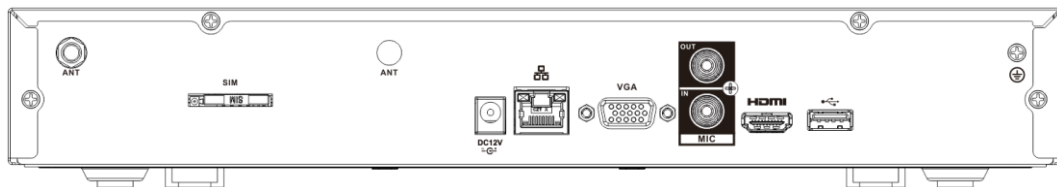



Table 2-26

Port Name	Connection	Function
ANT	Antenna port	Used to connect a 4G antenna.
SIM	SIM card slot	Used to insert a 4G SIM card which offers 4G data connectivity.
	Power input port	Power socket.
	Network port	10M/100Mbps self-adaptive Ethernet port. Connect to the network cable.
VGA	VGA video output port	VGA video output port. Outputs analog video signal. It can connect to the monitor to view analog video.
MIC IN	Audio input port	Two-way talk input port. It is to receive the analog audio signal output from the devices such as microphone, pickup.
MIC OUT	Audio output port	Audio output port. It is to output the analog audio signal to the devices such as the sound box. <ul style="list-style-type: none"> • Bidirectional talk output. • Audio output on 1-window video monitor. • Audio output on 1-window video playback.

Port Name	Connection	Function
HDMI	High Definition Media Interface	High definition audio and video signal output port. It transmits uncompressed high definition video and multiple-channel data to the HDMI port of the display device. HDMI version is 1.4.
	USB port	Connect to mouse, USB storage device and more.
	GND	Ground end

2.2.2 NVR4 Series

2.2.2.1 NVR4208-8P-I Series



These figures are for reference only. The actual product shall prevail.

Figure 2-32

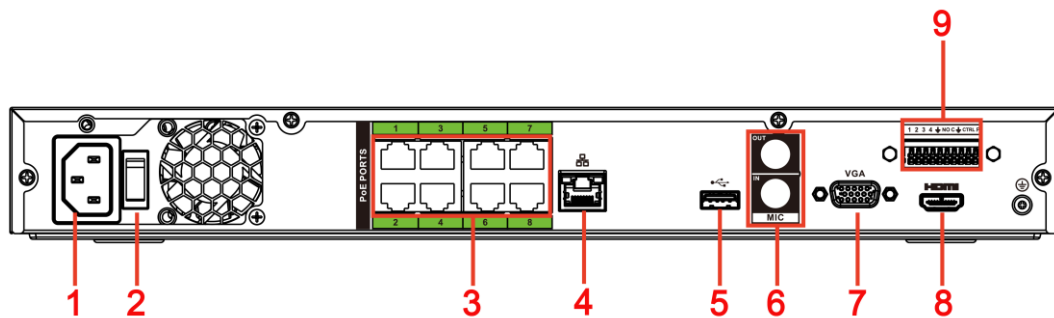

No.	Port Name	Function
1	Power input port	Input power of 100V-240V and 50Hz-60Hz.
2	Power button	Turns on/off the NVR.
3	PoE port	Built-in switch. It can provide power for IPC. 8 PoE ports: 1-8 are ePoE ports (support 300m @ 100M. 800m @ 10M). The device supports 48V, 100W total power output under 55°C, and 48V, 130W total power output under 45°C.
4	Network port	10M/100M/1000Mbps self-adaptive Ethernet port. Connect to the network cable.
5	USB port	USB3.0 port. Connect to devices such as mouse, USB storage device and USB burner.
6	MIC IN	Bidirectional talk input port. It is to receive analog audio signal from devices such as microphone, sound pickup.

No.	Port Name	Function
	MIC OUT	Audio output port. It is to output analog audio signal to devices such as sound box. <ul style="list-style-type: none"> • Bidirectional talk output. • Audio output on 1-window video monitor. • Audio output on 1-window video playback.
7	VGA port	VGA video output port. Output analog video signal. It can connect to the monitor to view analog video.
8	HDMI port	High definition audio and video signal output port. It transmits uncompressed high definition video and multiple-channel audio data to displays with HDMI port.
9	Alarm input port (1-4)	<ul style="list-style-type: none"> • They receive signals from external alarm source. Alarm input includes two types; NO (normal open) and NC (normal close). • When your alarm input device is using external power, make sure the device and the NVR have the same GND.
		GND. Alarm input ground port.
	NO C	One NO activation output group. (On-off button).
	CTRL	Controllable power supply output. Control the output of the on-off button alarm relay. It controls the alarm device with the presence or absence of voltage. It can also be used as power input for some alarm devices such as alarm detectors.
	P	Power output port. It can provide power to some peripheral devices such as camera and alarm device. Make sure the power supply of peripheral device shall be below 1A.

2.2.2.2 NVR4216-I Series



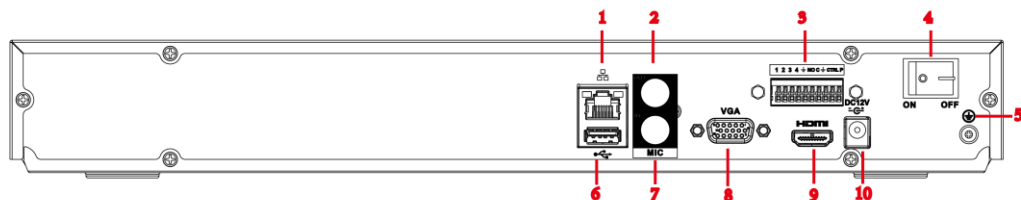

The figure is for reference only. The actual product shall prevail.

Figure 2-33



No.	Port Name	Function
1	Network port	10M/100M/1000Mbps self-adaptive Ethernet port. Connect to the network cable.

No.	Port Name	Function
2	MIC OUT	<p>Audio output port. It is to output analog audio signal to devices such as sound box.</p> <ul style="list-style-type: none"> • Bidirectional talk output. • Audio output on 1-window video monitor. • Audio output on 1-window video playback.
3	Alarm input port (1-4)	<ul style="list-style-type: none"> • They receive signals from external alarm source. Alarm input includes two types; NO (normal open) and NC (normal close). • When your alarm input device is using external power, make sure the device and the NVR have the same GND.
		GND. Alarm input ground port.
	NO C	One NO activation output group. (On-off button).
	CTRL	Controllable power supply output. Control the output of the on-off button alarm relay. It controls the alarm device with the presence or absence of voltage. It can also be used as power input for some alarm devices such as alarm detectors.
	P	Power output port. It can provide power to some peripheral devices such as camera and alarm device. Make sure the power supply of peripheral device shall be below 1A.
4	Power button	Turns on/off the NVR.
5		GND.
6	USB port	USB3.0 port. Connect to devices such as mouse, USB storage device and USB burner.
7	MIC IN	Bidirectional talk input port. It is to receive analog audio signal from devices such as microphone, sound pickup.
8	VGA port	VGA video output port. Output analog video signal. It can connect to the monitor to view analog video.
9	HDMI port	High definition audio and video signal output port. It transmits uncompressed high definition video and multiple-channel audio data to displays with HDMI port.
10	Power input port	Input power of 100V-240V and 50Hz-60Hz.

2.2.3 NVR5 Series

2.2.3.1 NVR58-I/4832-I Series



- The figure takes NVR58-I/4832-I series as examples.
- The figure is for reference only. The actual product shall prevail.

Figure 2-34

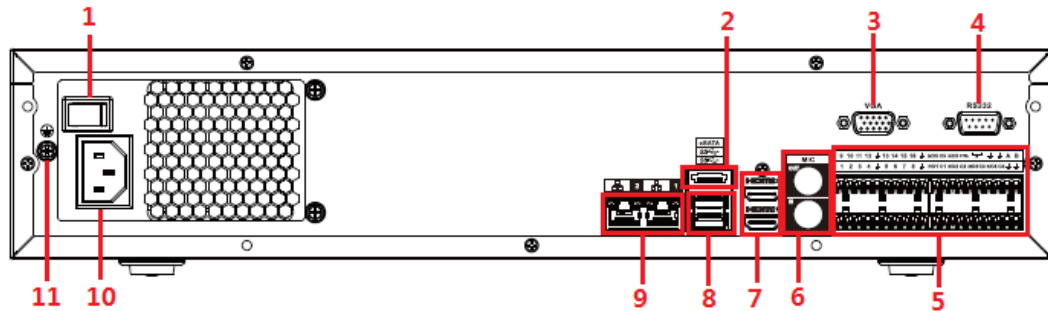



Table 2-27

No.	Port Name	Function
1	Power button	Turns on/off the NVR.
2	eSATA port	External SATA port. It can connect device with SATA port. You need to jump the HDD when there is peripherally connected HDD.
3	VGA port	VGA video output port. Output analog video signal. It can connect to the monitor to view analog video.
4	RS232 port	It is for general COM debugging to configure IP address and transfer transparent COM data.
5	Alarm input port (1-16)	<ul style="list-style-type: none"> • There are four groups: 1-4, 5-8, 9-12 and 13-16. They receive signals from external alarm source. Alarm input includes two types; NO (normal open) and NC (normal close). • When your alarm input device is using external power, make sure the device and the NVR have the same GND.
	Alarm output port (NO1-NO5, C1-C5, NC5)	<ul style="list-style-type: none"> • Five groups of alarm output ports (Group 1: NO1-C1, Group 2: NO2-C2, Group 3: NO3-C3, Group 4: NO4-C4, Group 5: NO5, C5, NC5). Output alarm signal to the external alarm device. Make sure power supply is available for the external alarm device. • NO: Normal open alarm output port. • C: Alarm output public end. • NC: Normal close alarm output port.
		GND. Alarm input ground port.

No.	Port Name	Function
	RS485 port (A, B)	<ul style="list-style-type: none"> • RS485_A port. Control cable A of the 485 device. It connects external devices such as speed dome and PTZ. • RS485_B port. Control cable B of the 485 device. It connects external devices such as speed dome and PTZ.
	CTRL	Controllable 12V power output. It is to control the on-off alarm relay output. It can be used to control the device alarm output. At the same time, it can also be used as the power input source of some devices such as alarm detector.
		+12V power output port. It can provide power to some peripheral devices such as camera and alarm device. Make sure the power supply of peripheral device shall be below 1A.
6	MIC IN	Bidirectional talk input port. It is to receive analog audio signal from devices such as microphone, sound pickup.
	MIC OUT	<p>Audio output port. It is to output analog audio signal to devices such as sound box.</p> <ul style="list-style-type: none"> • Bidirectional talk output. • Audio output on 1-window video monitor. • Audio output on 1-window video playback.
7	HDMI port	High definition audio and video signal output port. It transmits uncompressed high definition video and multiple-channel audio data to displays with HDMI port. The two HDMI ports support 2-channel high definition HDMI output of different sources.
8	USB port	USB3.0 port. Connect to devices such as mouse, USB storage device and USB burner.
9	Network port	10M/100M/1000Mbps self-adaptive Ethernet port. Connect to the network cable.
10	Power input port	Input power of 100V-240V and 50Hz-60Hz.
11		GND.

2.2.3.2 NVR54-16P-I/4416-16P-I/4432-I Advanced 1.5U 4HDD 16PoE AI NVR/General 1.5U 4HDD 16PoE AI NVR/General 1.5U 4HDD AI NVR Series



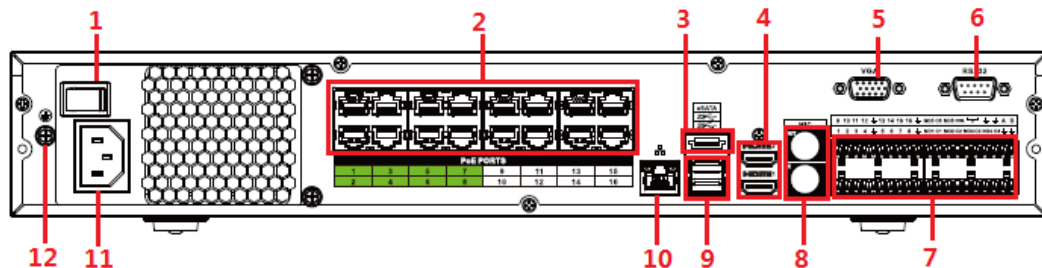

- Figure 2-4 takes NVR5432-16P-I series as examples.
- The figure is for reference only. The actual product shall prevail.

Figure 2-35



No.	Port Name	Function
1	Power button	Turns on/off the NVR.
2	PoE port	Built-in switch. It can provide power for IPC. <ul style="list-style-type: none"> • 16 PoE ports: 1-8 are ePoE ports (support 300m @ 100M. 800m @ 10M). 9-16 are regular PoE ports. • Device with 16 PoEs supports 150W total power.
3	eSATA port	External SATA port. It can connect device with SATA port. You need to jump the HDD when there is peripherally connected HDD.
4	HDMI port	High definition audio and video signal output port. It transmits uncompressed high definition video and multiple-channel audio data to displays with HDMI port. The two HDMI ports support 2-channel high definition HDMI output of different sources.
5	VGA port	VGA video output port. Output analog video signal. It can connect to the monitor to view analog video.
6	RS232 port	It is for general COM debugging to configure IP address and transfer transparent COM data.
7	Alarm input port (1-16)	<ul style="list-style-type: none"> • There are four groups: 1-4, 5-8, 9-12 and 13-16. They receive signals from external alarm source. Alarm input includes two types; NO (normal open) and NC (normal close). • When your alarm input device is using external power, make sure the device and the NVR have the same GND.

No.	Port Name	Function
	Alarm output port (NO1-NO5, C1-C5, NC5)	<ul style="list-style-type: none"> Five groups of alarm output ports (Group 1: NO1-C1, Group 2: NO2-C2, Group 3: NO3-C3, Group 4: NO4-C4, Group 5: NO5, C5, NC5). Output alarm signal to the external alarm device. Make sure power supply is available for the external alarm device. NO: Normal open alarm output port. C: Alarm output public end. NC: Normal close alarm output port.
		GND. Alarm input ground port.
	RS485 port (A, B)	<ul style="list-style-type: none"> RS485_A port. Control cable A of the 485 device. It connects external devices such as speed dome and PTZ. RS485_B port. Control cable B of the 485 device. It connects external devices such as speed dome and PTZ.
	CTRL	Controllable 12V power output. It is to control the on-off alarm relay output. It can be used to control the device alarm output. At the same time, it can also be used as the power input source of some devices such as alarm detector.
8		+12V power output port. It can provide power to some peripheral devices such as camera and alarm device. Make sure the power supply of peripheral device shall be below 1A.
	MIC IN	Bidirectional talk input port. It is to receive analog audio signal from devices such as microphone, sound pickup.
	MIC OUT	Audio output port. It is to output analog audio signal to devices such as sound box. <ul style="list-style-type: none"> Bidirectional talk output. Audio output on 1-window video monitor. Audio output on 1-window video playback.
9	USB port	USB3.0 port. Connect to devices such as mouse, USB storage device and USB burner.
10	Network port	10M/100M/1000Mbps self-adaptive Ethernet port. Connect to the network cable.
11	Power input port	Input power of 100V-240V and 50Hz-60Hz.
12		GND.

2.2.3.3 NVR52-16P-I/52-8P-I/42-16P-I Series



These figures are for reference only. The actual product shall prevail.

Figure 2-36

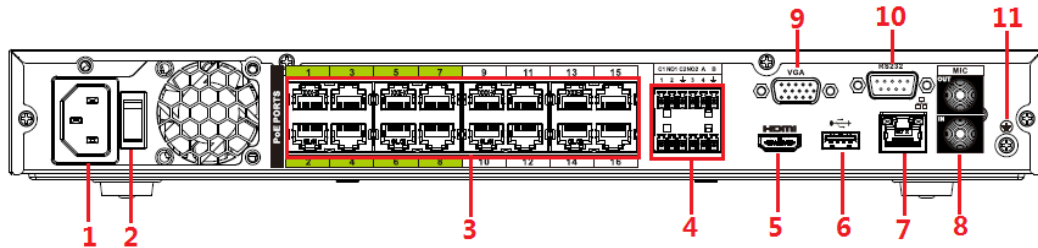

Figure 2-37

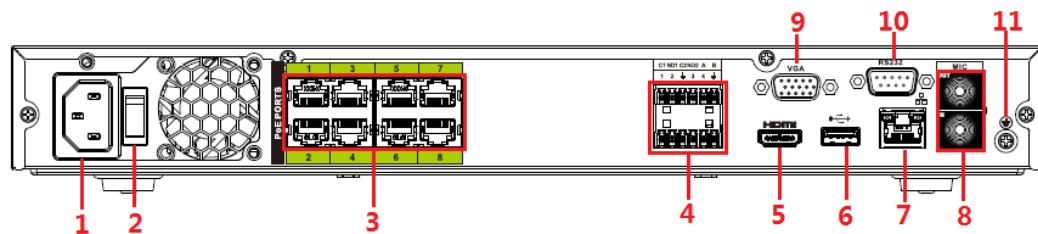
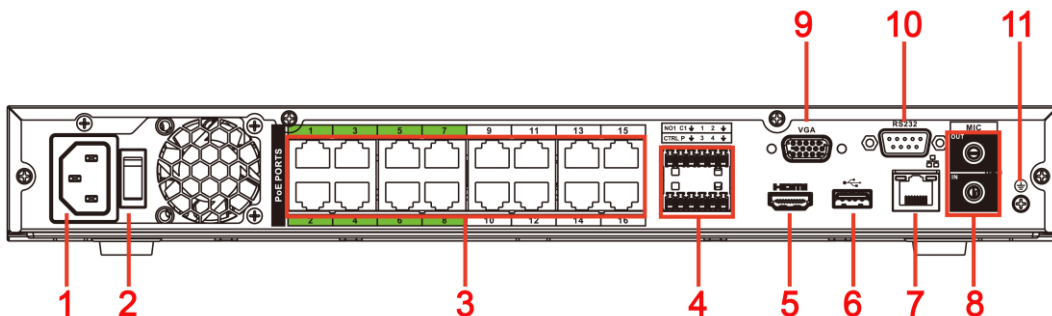



Figure 2-38



No.	Port Name	Function
1	Power input port	Input power of 100V-240V and 50Hz-60Hz.
2	Power button	Turns on/off the NVR.
3	PoE port	Built-in switch. It can provide power for IPC. 16 PoE ports: 1-8 are ePoE ports (support 300m @ 100M. 800m @ 10M). 9-16 are regular PoE ports. The device supports 150W total power. 8 PoE ports: 1-8 are ePoE ports (support 300m @ 100M. 800m @ 10M). The device supports 48V, 120W total power.

No.	Port Name	Function	
4	Alarm input/output of NVR52-16P-I and 52-8P-I	Alarm input port (1-4)	<ul style="list-style-type: none"> They receive signals from external alarm source. Alarm input includes two types; NO (normal open) and NC (normal close). When your alarm input device is using external power, make sure the device and the NVR have the same GND.
		Alarm output port (NO1-NO2, C1-C2)	<ul style="list-style-type: none"> Two groups of alarm output ports (Group 1: NO1-C1, Group 2: NO2-C2). Output alarm signal to the external alarm device. Make sure power supply is available for the external alarm device. NO: Normal open alarm output port. C: Alarm output public end.
			GND. Alarm input ground port.
		RS485 port (A, B)	<ul style="list-style-type: none"> RS485_A port. Control cable A of the 485 device. It connects external devices such as speed dome and PTZ. RS485_B port. Control cable B of the 485 device. It connects external devices such as speed dome and PTZ.
4	Alarm input/output of NVR4216-16P-I	Alarm input port (1-4)	<ul style="list-style-type: none"> They receive signals from external alarm source. Alarm input includes two types; NO (normal open) and NC (normal close). When your alarm input device is using external power, make sure the device and the NVR have the same GND.
		Alarm output port (NO1, C1)	<ul style="list-style-type: none"> One group of alarm output ports (Group 1: NO1-C1). Output alarm signal to the external alarm device. Make sure power supply is available for the external alarm device. NO: Normal open alarm output port. C: Alarm output public end.
			GND. Alarm input ground port.
		CTRL	Controllable 12V power output. It is to control the on-off alarm relay output. It can be used to control the device alarm output. At the same time, it can also be used as the power input source of some devices such as alarm detector.

No.	Port Name	Function
		P +12V power output port. It can provide power to some peripheral devices such as camera and alarm device. Make sure the power supply of peripheral device shall be below 1A.
5	HDMI port	High definition audio and video signal output port. It transmits uncompressed high definition video and multiple-channel audio data to displays with HDMI port.
6	USB port	USB3.0 port. Connect to devices such as mouse, USB storage device and USB burner.
7	Network port	10M/100M/1000Mbps self-adaptive Ethernet port. Connect to the network cable.
8	MIC IN	Bidirectional talk input port. It is to receive analog audio signal from devices such as microphone, sound pickup.
	MIC OUT	Audio output port. It is to output analog audio signal to devices such as sound box. <ul style="list-style-type: none"> • Bidirectional talk output. • Audio output on 1-window video monitor. • Audio output on 1-window video playback.
9	VGA port	VGA video output port. Output analog video signal. It can connect to the monitor to view analog video.
10	RS232 port	It is for general COM debugging to configure IP address and transfer transparent COM data.
11		GND.

2.2.4 NVR6 Series

2.2.4.1 NVR608-4KS2 Series

The NVR608-32-4KS2 series rear panel is shown as below.

Figure 2-39

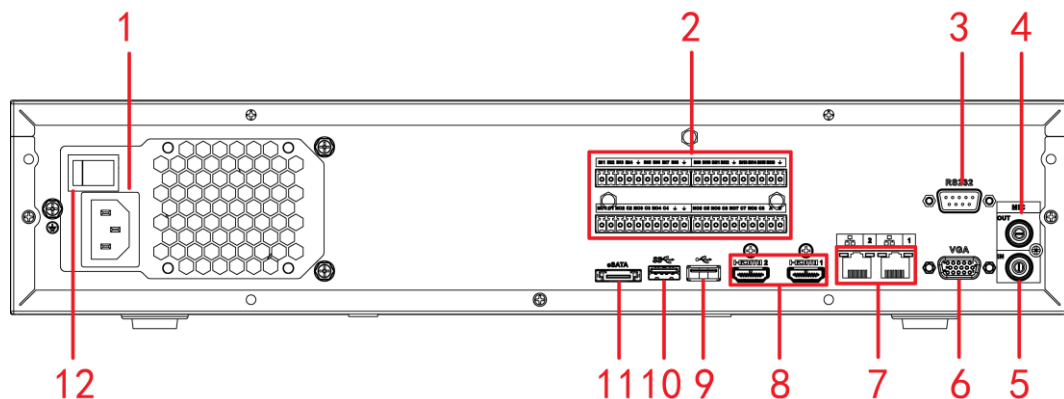

The NVR608-64-4KS2/NVR608-128-4KS2 general series rear panel is shown as below.

Figure 2-40

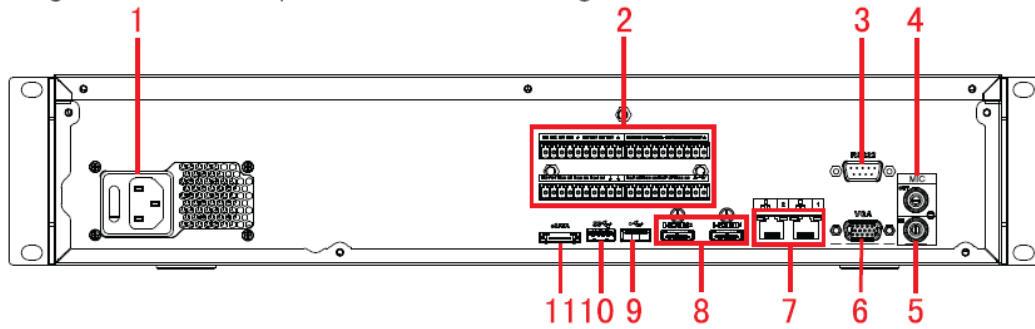

The NVR608-64-4KS2, NVR608-128-4KS2 redundant power series rear panel is shown as below.

Figure 2-41

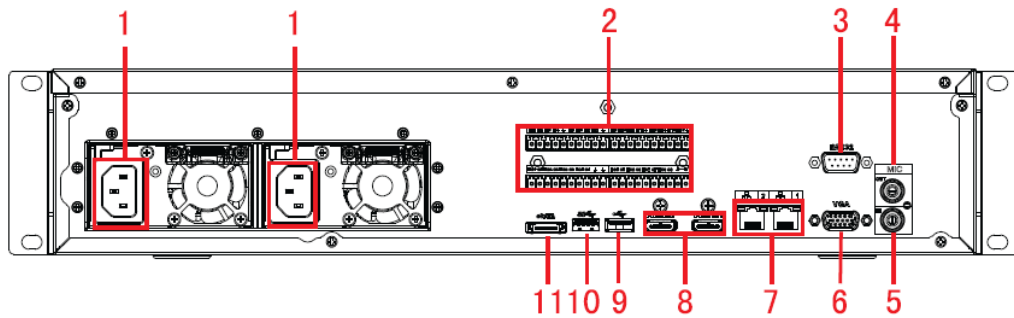

Table 2-28

SN	Function	SN	Function
1	Power socket	2	Alarm input/alarm output/RS485 port
2	RS232 port	4	Audio output
5	Audio input	6	VGA port
7	Network port	8	HDMI port
9	<ul style="list-style-type: none"> NVR608-4K: USB 2.0 port. NVR608-4KS2: USB 3.0 port 	10	USB 3.0 port
11	eSATA port	/	/

2.2.4.2 NVR616-4KS2 Series

The general series rear panel of NVR616-4KS2 is shown as below.

Figure 2-42

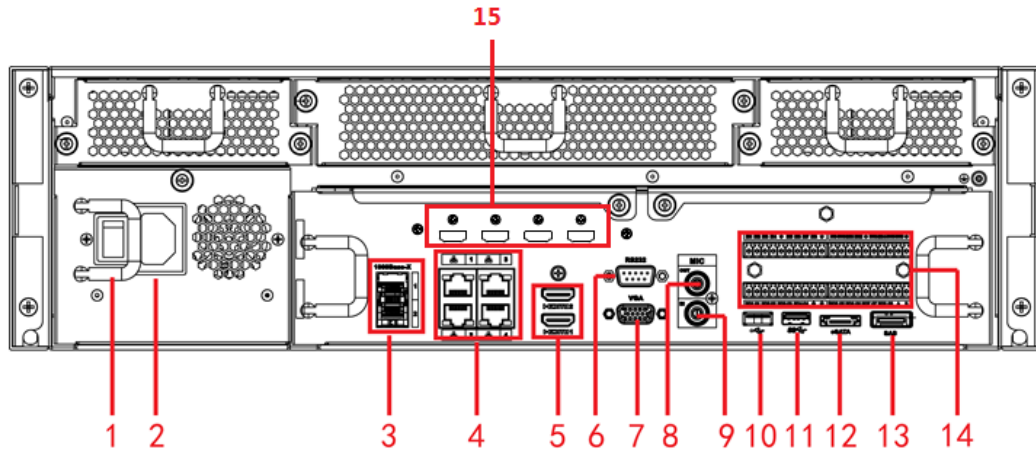

The redundant power series rear panel of NVR616-4KS2 is shown as below.

Figure 2-43

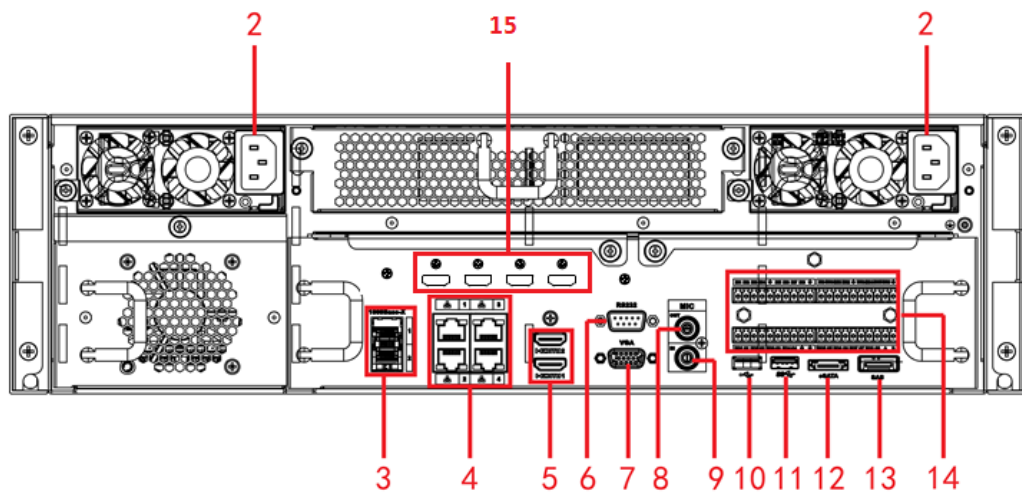



Table 2-29

SN	Name	SN	Name
1	Power on-off button	2	Power socket
3	1000M fiber port	4	Network port
5	HDMI port	6	RS232 port
7	Video VGA output	8	Audio output
9	Audio input	10	USB3.0 port
11	USB3.0 port	12	eSATA port
13	SAS extension port	14	Alarm input/output/RS485 port
15	HDMI port  High-definition decoding card is not installed in standard hardware configuration, you can purchase as needed.	/	/

2.2.4.3 NVR624-4KS2Advanced 4U 24HDD AI NVR Series

The general series rear panel of NVR624-4KS2Advanced 4U 24HDD AI NVR is shown as below.

Figure 2-44

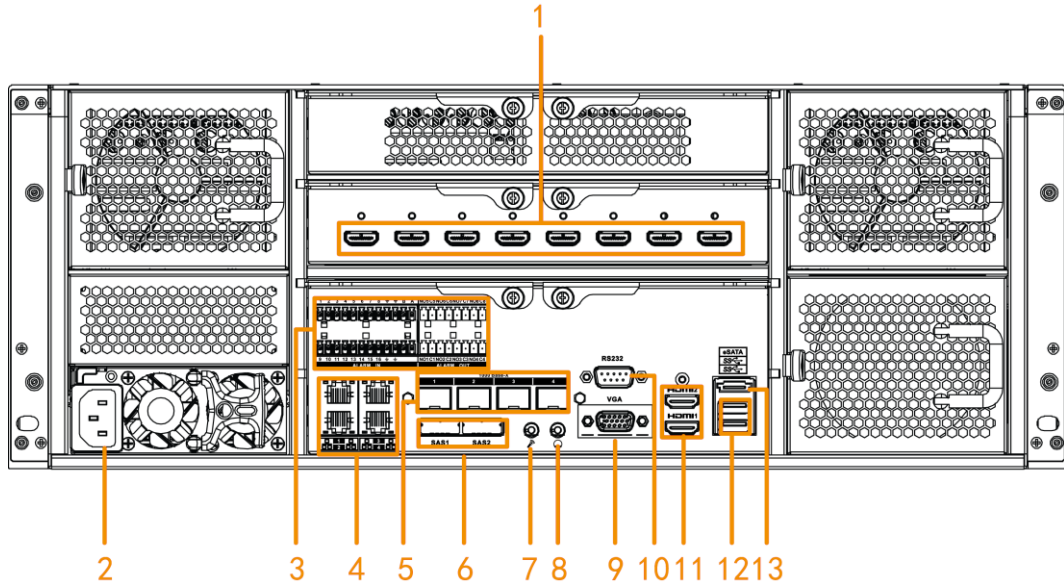

The redundant power series rear panel of NVR624-128-4KS2 is shown as below.

Figure 2-45

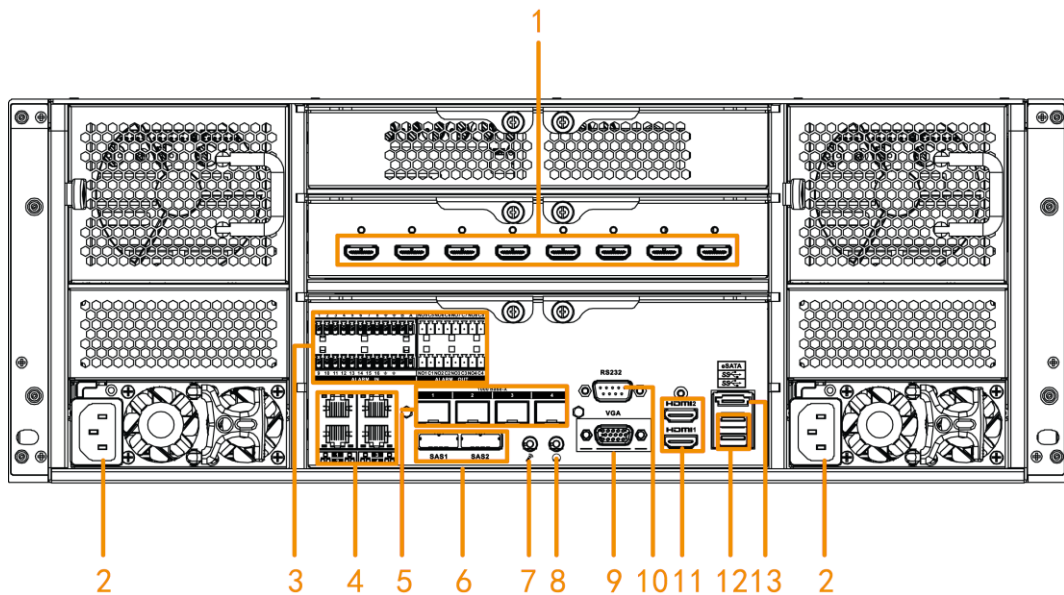



Table 2-30

SN	Name	SN	Name
1	HDMI port  High-definition decoding card is not installed in standard hardware configuration, you can purchase as needed.	2	Power socket

SN	Name	SN	Name
3	Alarm input/output/RS485 port	4	Network port
5	1000M fiber port  Fiber port module is not installed in standard hardware configuration, you can purchase as needed.	6	SAS extension port
7	Audio input	8	Audio output
9	Video VGA output	10	RS232 port
11	HDMI port	12	USB 3.0 port
13	eSATA port	/	/

2.3 Alarm Connection

2.3.1 Alarm Port

The alarm port is shown as below. See Figure 2-46. The following figure is for reference only.

Figure 2-46 Alarm Port

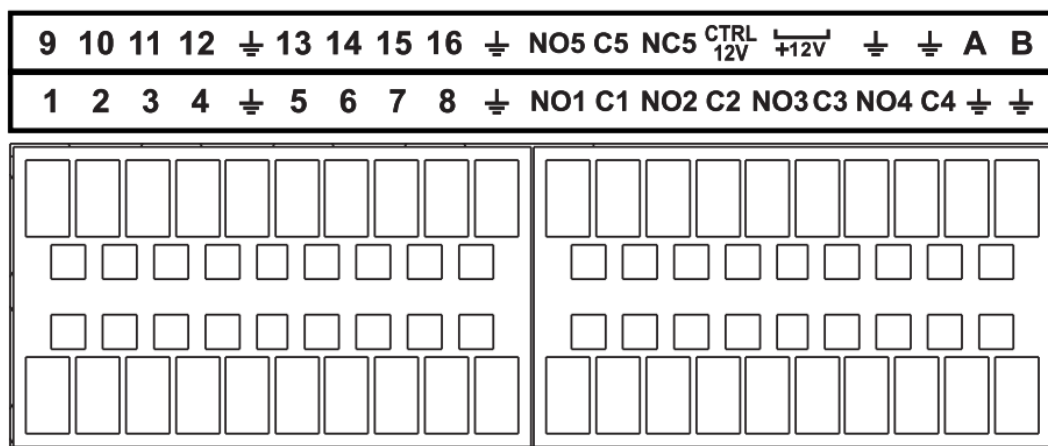



Table 2-31

Icon	Function
1–16	ALARM1–ALARM16. The alarm becomes activated in the low level.
NO1 C1, NO2 C2, NO3 C3, NO4 C4	Four NO activation output groups. (On-off button).
NO5 C5 NC5	One NO/NC activation output group. (On-off button).
CTRL 12V	Control power output. Disable power output when alarm is canceled. Current is 500mA.
+12V	Rated current output. Current is 500mA.
	GND

Icon	Function
A/B	485 communication port. They are used to control devices such as PTZ. Please parallel connect 120TΩ between A/B cables if there are too many PTZ decoders.



- Different models support different alarm input ports. Please refer to the specifications sheet for detailed information.
- Slight difference may be found on the alarm port layout.

2.3.2 Alarm Input Port

Connect the positive end (+) of the alarm input device to the alarm input port (ALARM IN 1–16) of the NVR. Connect the negative end (-) of the alarm input device to the ground end (⏏) of the NVR.

Figure 2-47 Alarm input port

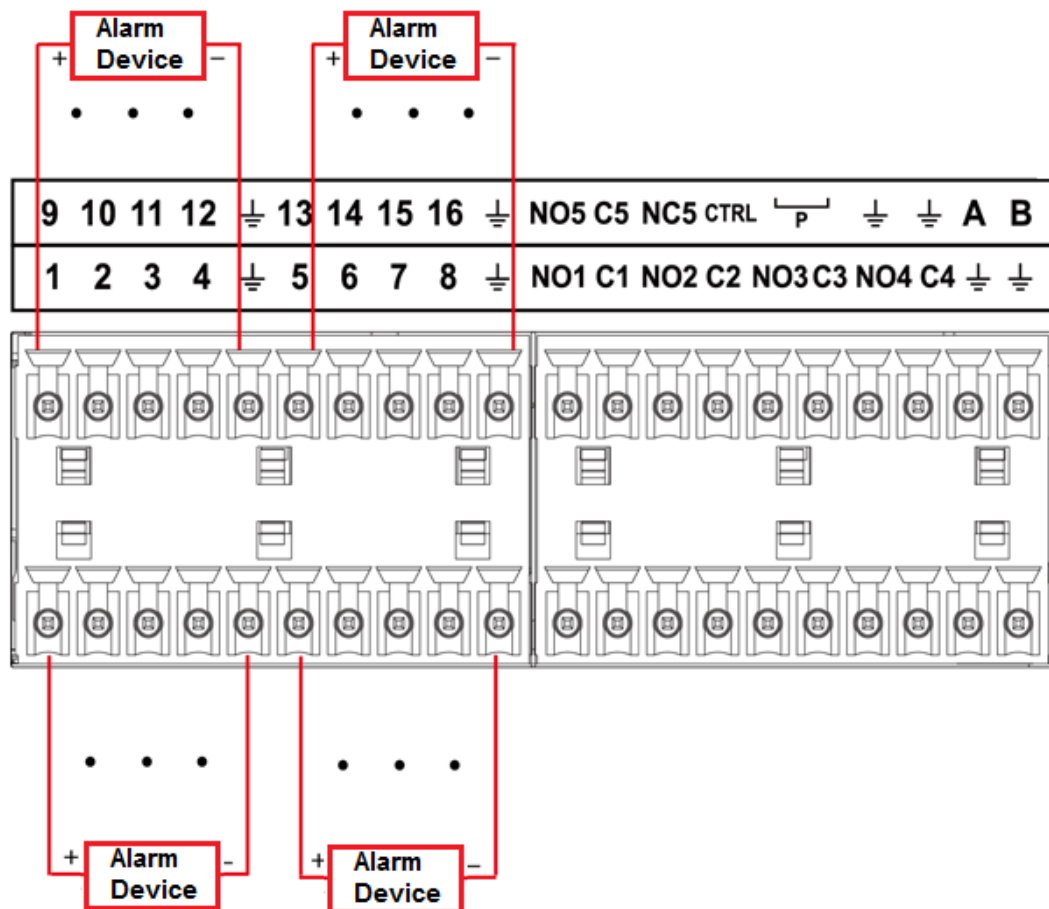

- There are two alarm input types: NO/NC.
- When connect the ground port of the alarm device to the NVR, you can use any of the GND ports (⏏).
- Connect the NC port of the alarm device to the alarm input port (ALARM) of the NVR.
- When there is peripheral power supplying for the alarm device, please make sure it is earthed with the NVR.

2.3.3 Alarm Output Port

- There is peripheral power supplying for the external alarm device.
- In case overload may result in NVR damage, please refer to the following relay specifications for detailed information.
- A/B cable of the RS485 is for the A/B cable connection of the speed PTZ.

2.3.4 Alarm Relay Specifications

Table 2-32 Alarm relay specifications

Model: JRC-27F		
Material of the touch	Silver	
Rating (Resistance	Rated switch capacity	30V DC 2A, 125V AC 1A

Model: JRC-27F		
Load)	Maximum switch power	125V AC, 160W
	Maximum switch voltage	250V AC, 220VDC
	Maximum switch currency	1A
Insulation	Between touches with same polarity	1000V AC 1minute
	Between touches with different polarity	1000V AC 1minute
	Between touch and winding	1000V AC 1minute
Surge voltage	Between touches with same polarity	1500V (10×160us)
Length of open time	3ms max	
Length of close time	3ms max	
Longevity	Mechanical	50×106 MIN (3Hz)
	Electrical	200×103 MIN (0.5Hz)
Temperature	-40°C to +70°C	

2.4 Two-way Talk

2.4.1 Device-end to PC-end

Device Connection

Please connect the speaker or the pickup to the first audio input port on the device rear panel. Then connect the earphone or the sound box to the audio output port in the PC.

Log in to the web and then enable the corresponding channel real-time monitor. Please refer to the following interface to enable two-way talk. See Figure 2-48.

Figure 2-48 Enable two-way talk

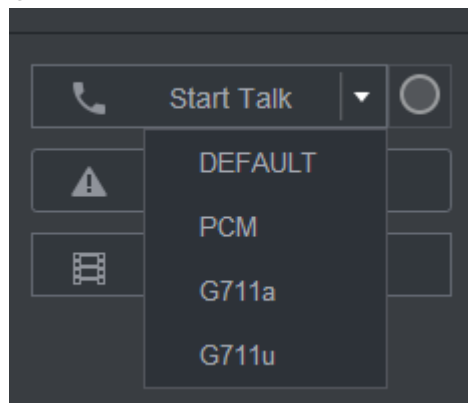

At the device end, speak by the speaker or the pickup, and then you can get the audio from the earphone or sound box at the pc-end. See Figure 2-49.

Figure 2-49 Device to PC

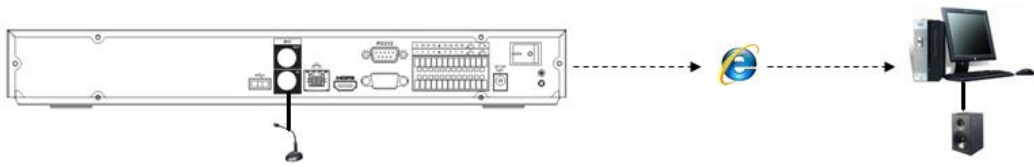

2.4.2 PC-end to the Device-end

Device Connection

Connect the speaker or the pickup to the audio output port in the PC and then connect the earphone or the sound box to the first audio input port in the device rear panel. Login the Web and then enable the corresponding channel real-time monitor. Please refer to the above interface Figure 2-48 to enable bidirectional talk.

Listening Operation

At the PC-end, speak by the speaker or the pickup, and then you can get the audio from the earphone or sound box at the device-end. See Figure 2-50.

Figure 2-50 PC to device

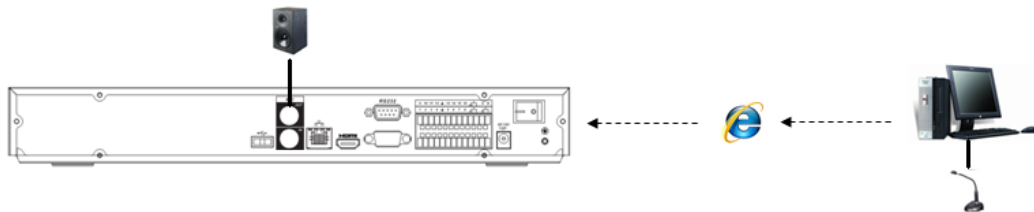

2.5 Mouse Operation

Refer to the following sheet for mouse operation instruction.

Table 2-33

Operation	Description
Left click mouse	When you have selected one menu item, left click mouse to view menu content.
	Modify checkbox or motion detection status.
	Click combo box to pop up drop-down list

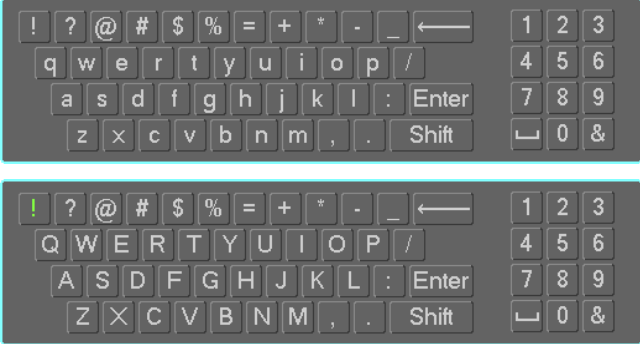
Operation	Description
	<p>In input box, you can select input methods. Left click the corresponding button on the panel you can input numeral/English character (lower case/upper case). Here ← stands for backspace button. _ stands for space button.</p> <p>In English input mode: _ stands for input a backspace icon and ← stands for deleting the previous character.</p>  <p>In numeral input mode: _ stands for clear and ← stands for deleting the previous numeral.</p>
Double left click mouse	Implement special control operation such as double click one item in the file list to playback the video.
	<p>In multiple-window mode, double left click one channel to view in full-window.</p> <p>Double left click current video again to go back to previous multiple-window mode.</p>
Right click mouse	In real-time monitor mode, pops up shortcut menu.
	Exit current menu without saving the modification.
Press middle button	In numeral input box: Increase or decrease numeral value.
	<p>Switch the items in the check box.</p> <p>Page up or page down.</p>
Move mouse	Select current control or move control.
Drag mouse	Select motion detection zone.
	Select privacy mask zone.

2.6 Remote Control

The remote control interface is shown as in Figure 2-51.

Note that remote control is not our standard accessory and it is not included in the accessory bag.

Figure 2-51

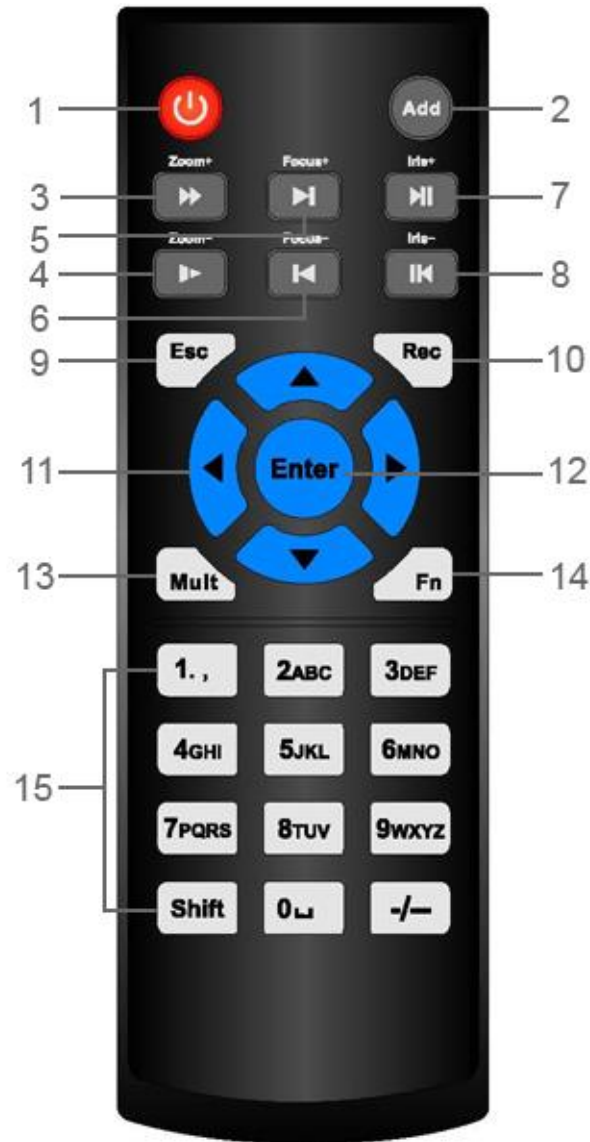

No.	Name	Function
1	Power button	Press this button to boot up or shut down the device.
2	Address	Press this button to input device serial number, so that you can control the Device.
3	Forward	Multi-step forward speed and normal speed playback.
4	Slow motion	Multi-step slow motion speed or normal playback.
5	Next record	In playback state, press this button to play back the next video.
6	Previous record	In playback state, press this button to play back the previous video.

No.	Name	Function
7	Play/Pause	<ul style="list-style-type: none"> ● In normal playback state, press this button to pause playback. ● In pause state, press this button to resume to normal playback. ● In live view window interface, press this button to enter video search menu.
8	Reverse/pause	In the reverse playback state, press this button to pause reverse playback.
		In the reverse playback pause state, press this button to resume to playback reversing state.
9	Esc	Go back to previous menu or cancel current operation (close front interface or control).
10	Record	<ul style="list-style-type: none"> ● Start or stop record manually. ● In record interface, use the direction buttons to select the channel that you want to record. ● Press this button for at least 1.5 seconds, and the manual record interface will be displayed.
11	Direction keys	Switch between current activated controls by going left or right.
		In playback state, the keys control the playback progress bar. Aux function (such as operating the PTZ menu).
12	Enter/menu key	<ul style="list-style-type: none"> ● Confirms an operation. ● Go to the OK button. ● Go to the menu.
13	Multiple-window switch	Switch between multiple-window and one-window.
14	Fn	<ul style="list-style-type: none"> ● In single-channel monitoring mode, press this button to display the PTZ control and color setting functions. ● Switch the PTZ control menu in PTZ control interface. ● In motion detection interface, press this button with direction keys to complete setup. ● In text mode, press and hold this button to delete the last character. To use the clearing function: Long press this button for 1.5 seconds. ● In HDD menu, switch HDD recording time and other information as indicated in the pop-up message.
15	Alphanumeric keys	<ul style="list-style-type: none"> ● Input password, numbers. ● Switch channel. ● Press Shift to switch the input method.

3 Device Installation



All the installation and operations here should conform to your local electric safety rules.

3.1 Device Installation Diagrams

Please refer to the following diagrams to install the NVR.

Figure 3-1 Installation flowchart

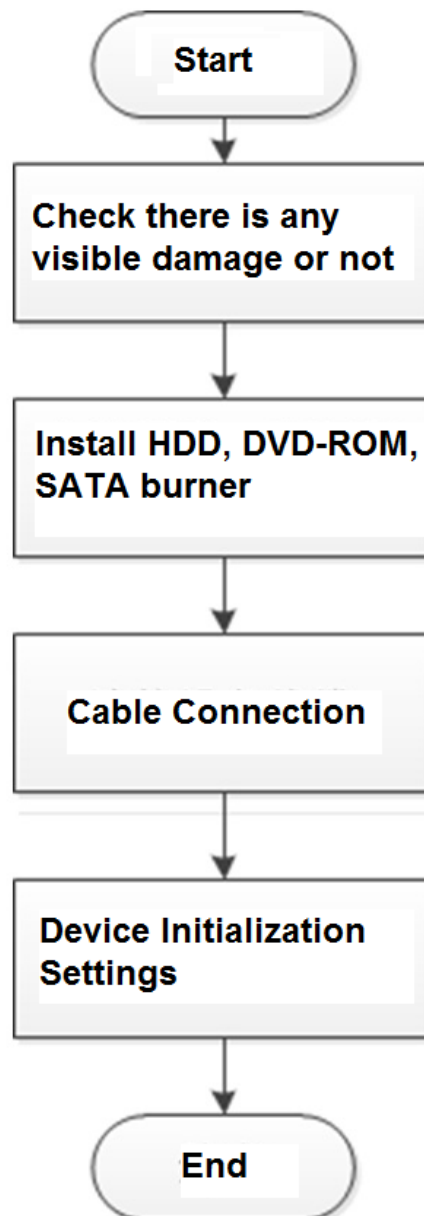

3.2 Check Unpacked NVR

When you receive the NVR from the forwarding agent, please check whether there is any visible damage. The protective materials used for the package of the NVR can protect most accidental clashes during transportation. Then you can open the box to check the accessories. Check the items in accordance with the list. Finally you can remove the protective film of the NVR.

3.3 About Front Panel and Rear Panel

The model number in the stick on the bottom of NVR is very important; please check according to your purchase order.

The label in the rear panel is very important too. Usually we need you to represent the serial number when we provide the service after sales.

3.4 HDD Installation

For the first time installation, make sure whether the HDD has been installed or not. We recommend to use HDD of enterprise level or surveillance level. It is not recommended to use PC HDD.



- Shut off the power before you replace the HDD.
- Use the dedicated SATA HDD for monitoring recommended by the HDD manufacturer.
- You can refer to the Appendix for HDD space information and recommended HDD brand.

3.4.1 NVR58-I/54-16P-I/4832-I/4416-16P-I/4432-I Series

Background Information



Different models have different HDD numbers. The actual product shall prevail.

Procedure

Step 1 Remove the fixing screws on the rear panel of the device.

Figure 3-2

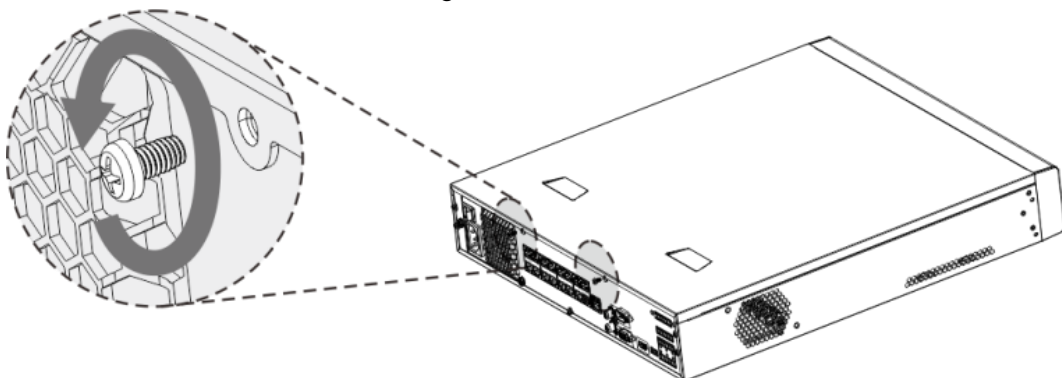

Step 2 Remove the case cover along the direction shown in the following arrow.

Figure 3-3

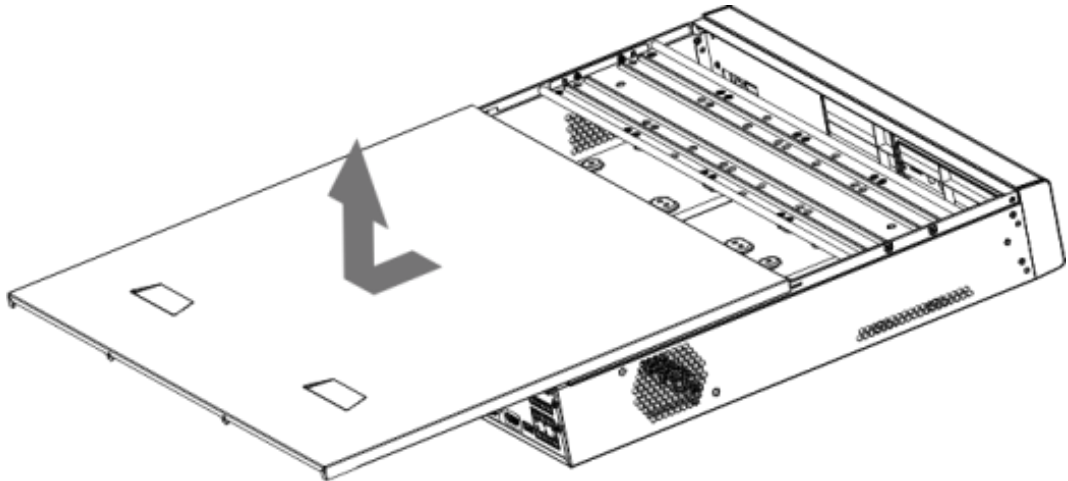

- Step 3** Remove the screws on the sides of HDD bracket to take out the bracket.
- 1.5U device has one HDD bracket. For the way to remove the bracket, see Figure 3-4
 - 2U device has two HDD brackets. For the way to remove the brackets, see Figure 3-5.

Figure 3-4

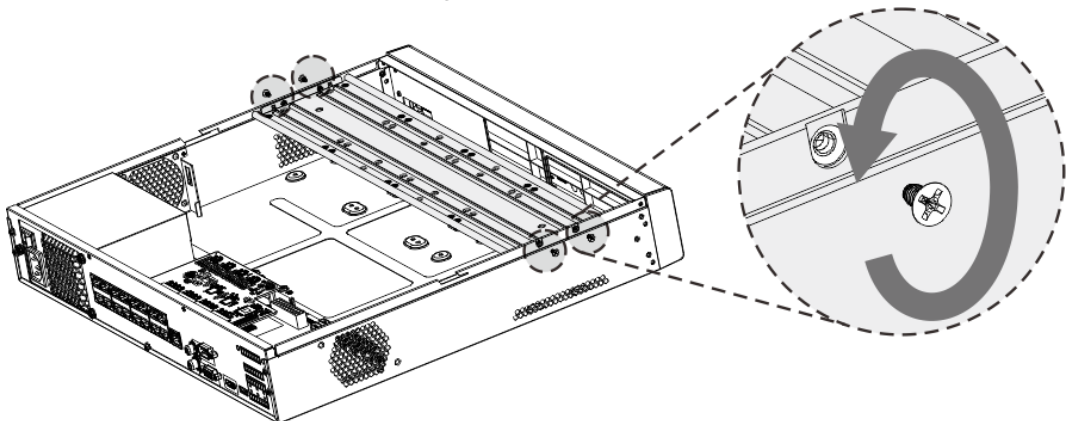
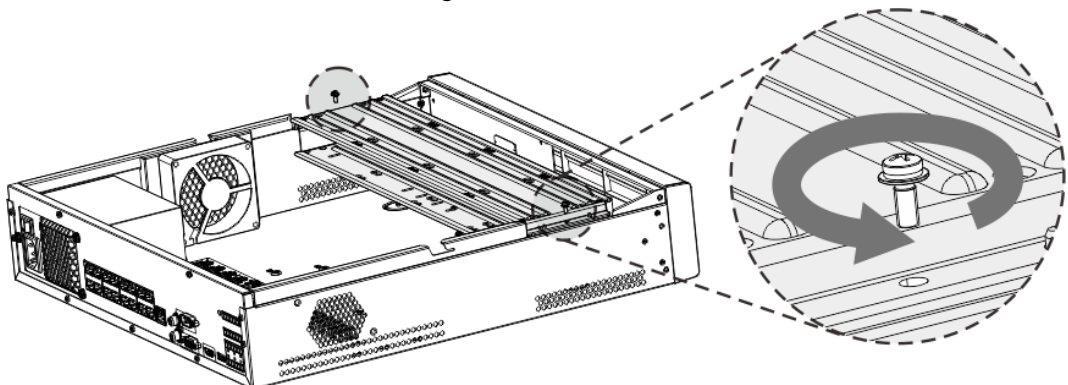
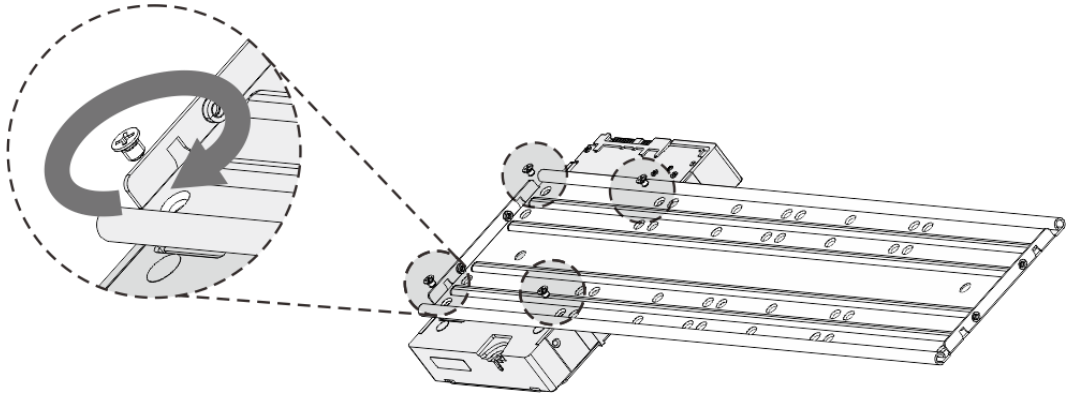

Figure 3-5



- Step 4** Match the four screw holes on the HDD with the four holes on the bracket and then fasten the screws.
The HDD is fixed to the bracket.

Figure 3-6



Step 5 Refer to Step 4 to install other HDDs.

Figure 3-7

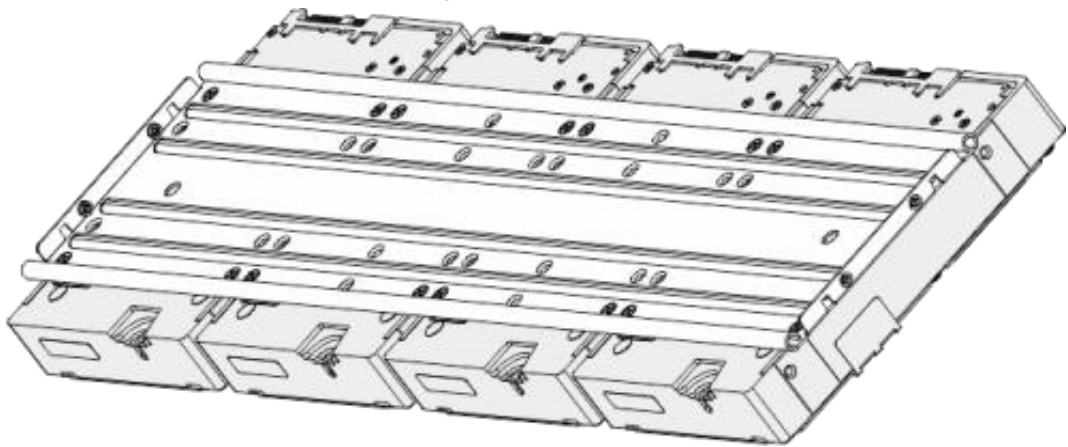

Step 6 Lock the two HDD brackets.



This step is required for 2U devices only.

Figure 3-8

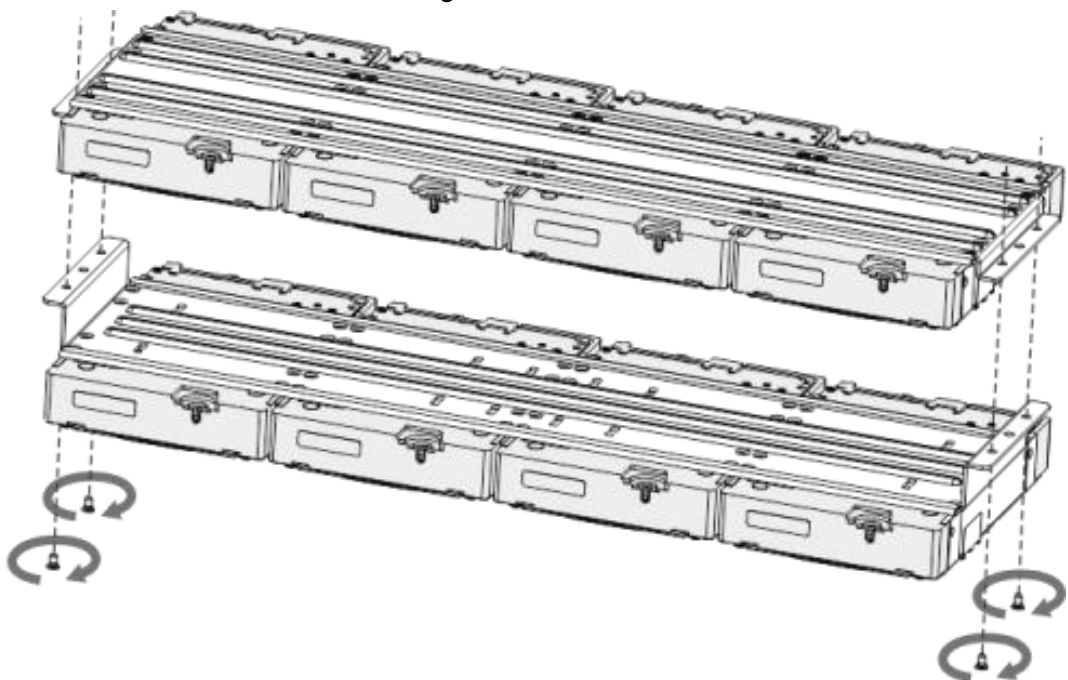

Step 7 Place the bracket to the device and then fasten the screws on the sides of the

bracket.

Figure 3-9

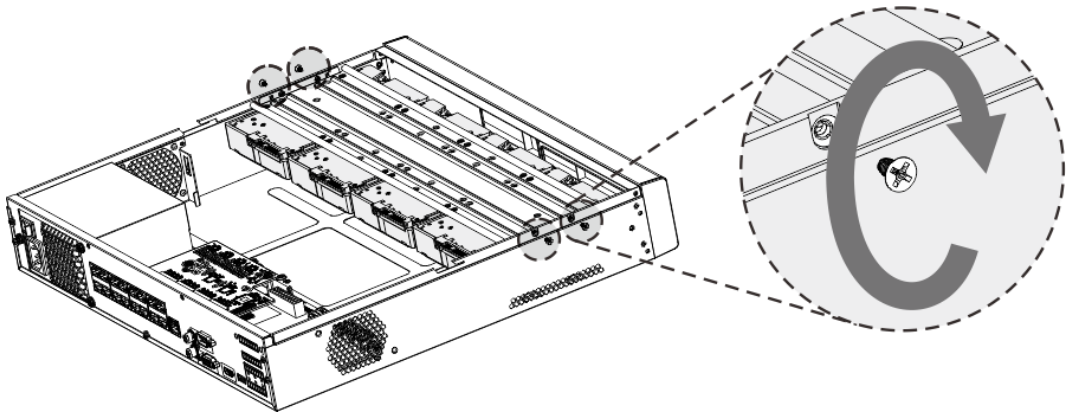

Step 8 Connect the HDD data cable and power cable to the device.



The following figure is for reference only. The actual product shall prevail.

Figure 3-10

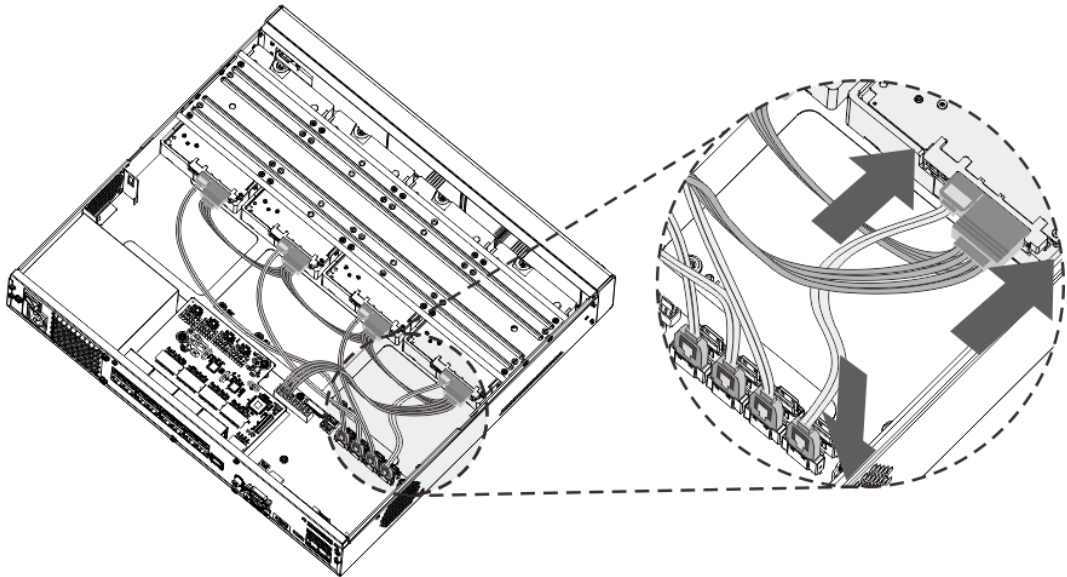

Step 9 Put back the cover and fasten the screws on the rear panel to complete the installation.

Figure 3-11

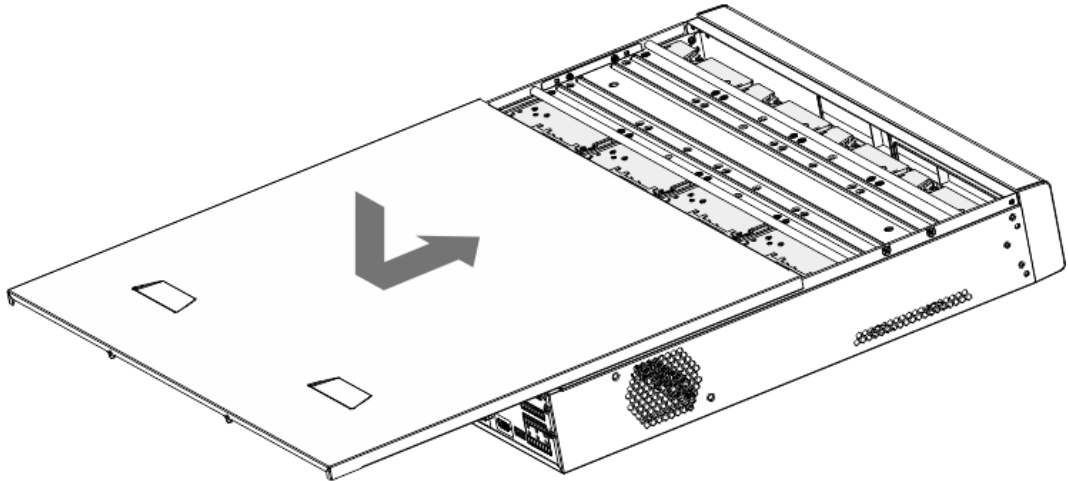

3.4.2 NVR52-16P-I/52-8P-I/4216-16P-I/4208-8P-I/4216-I Series

Background Information



Different models have different HDD numbers. The actual product shall prevail.

Procedure

Step 1 Remove the four fixing screws on the rear panel.

Figure 3-12

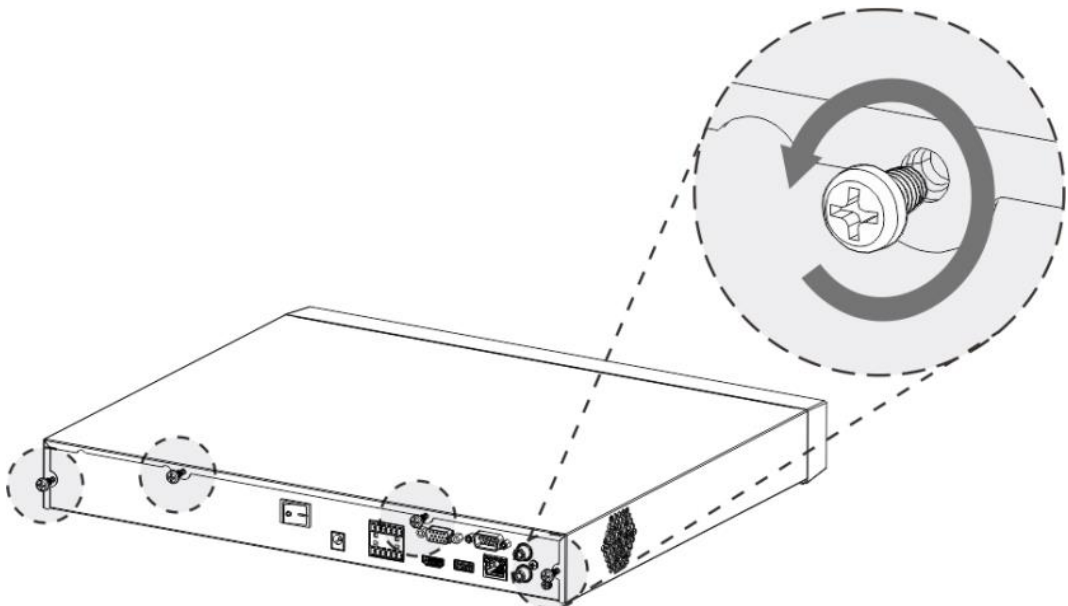

Step 2 Remove the case cover along the direction shown in the following arrow.

Figure 3-13

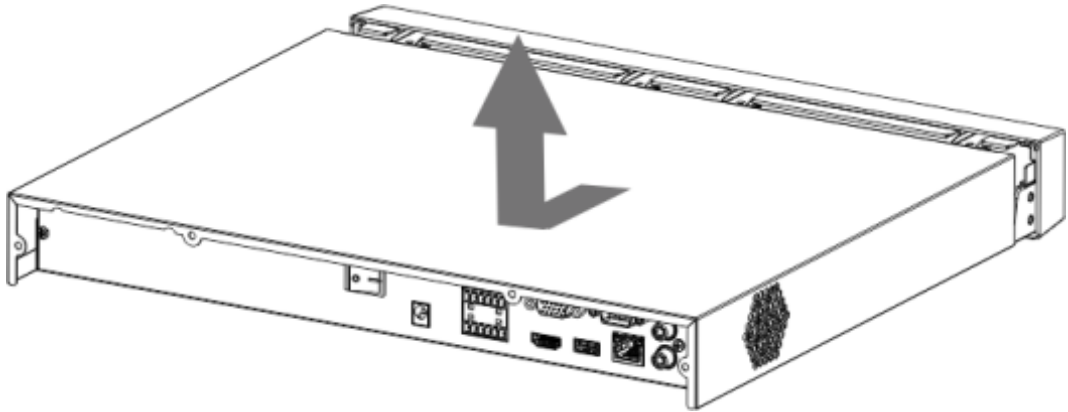

Step 3 Match the four holes on the baseboard to place the HDD.

Figure 3-14

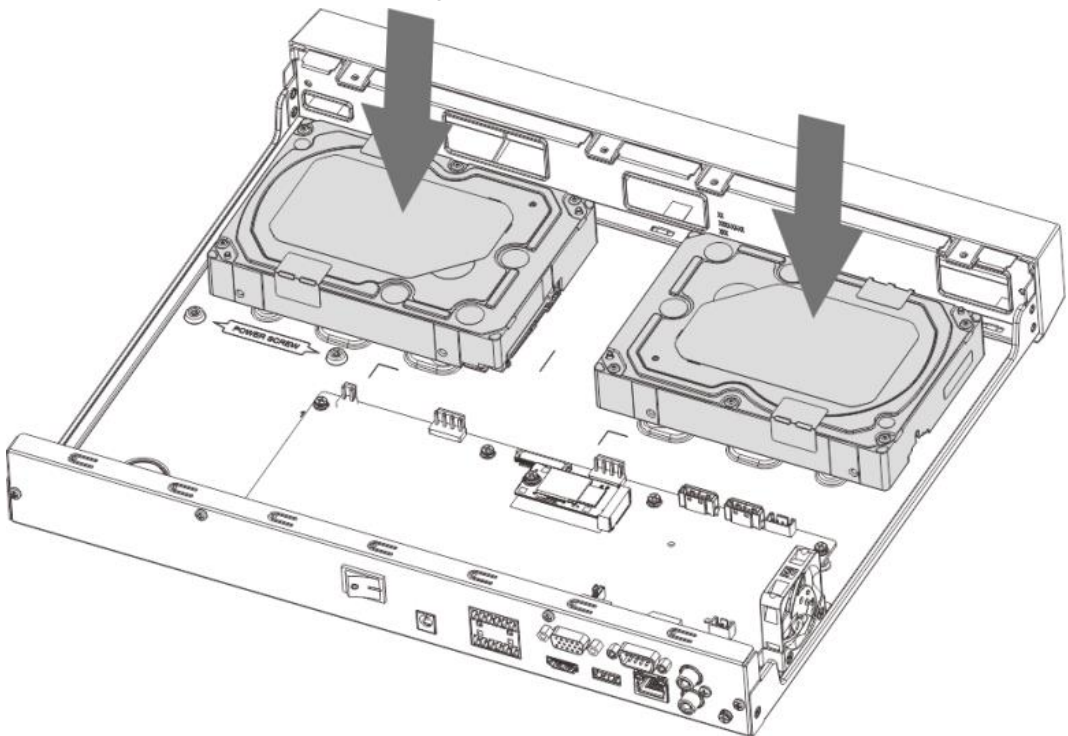

Step 4 Turn the device upside down, match the screws with the holes on the HDD and then fasten them. The HDD is fixed to the baseboard.

Figure 3-15

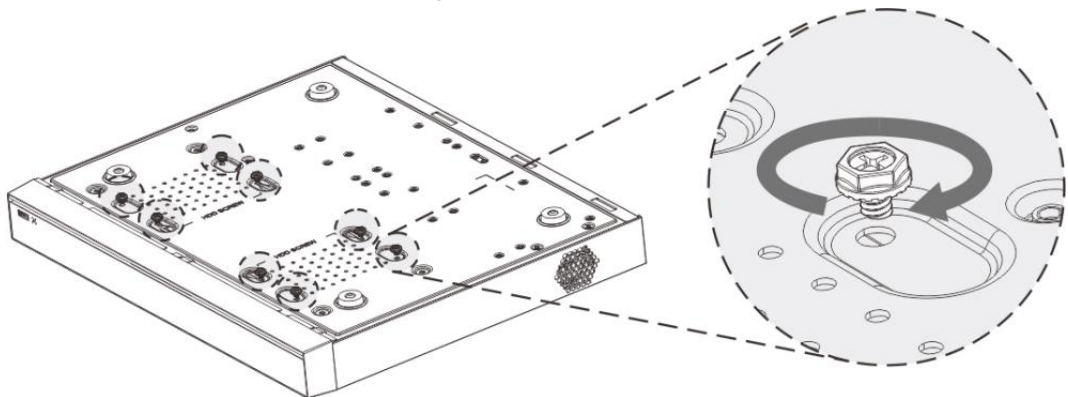

Step 5 Connect the HDD data cable and power cable to the device.

Figure 3-16

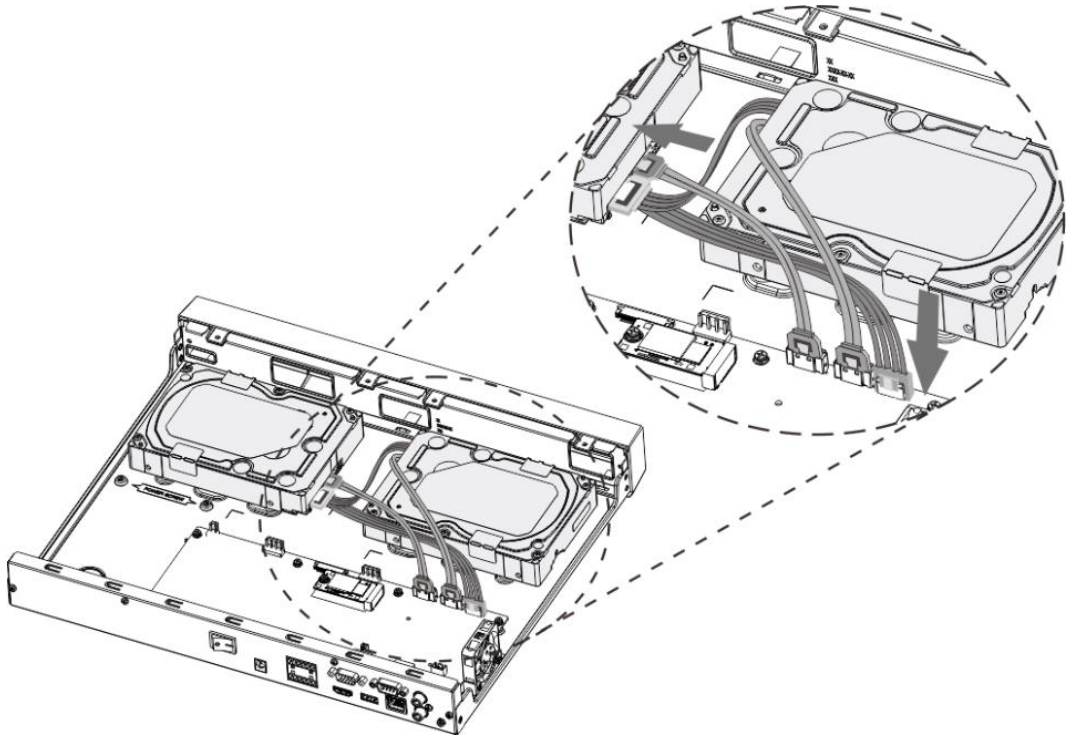

Step 6 Put back the cover and fasten the four screws on the rear panel to complete the installation.

Figure 3-17

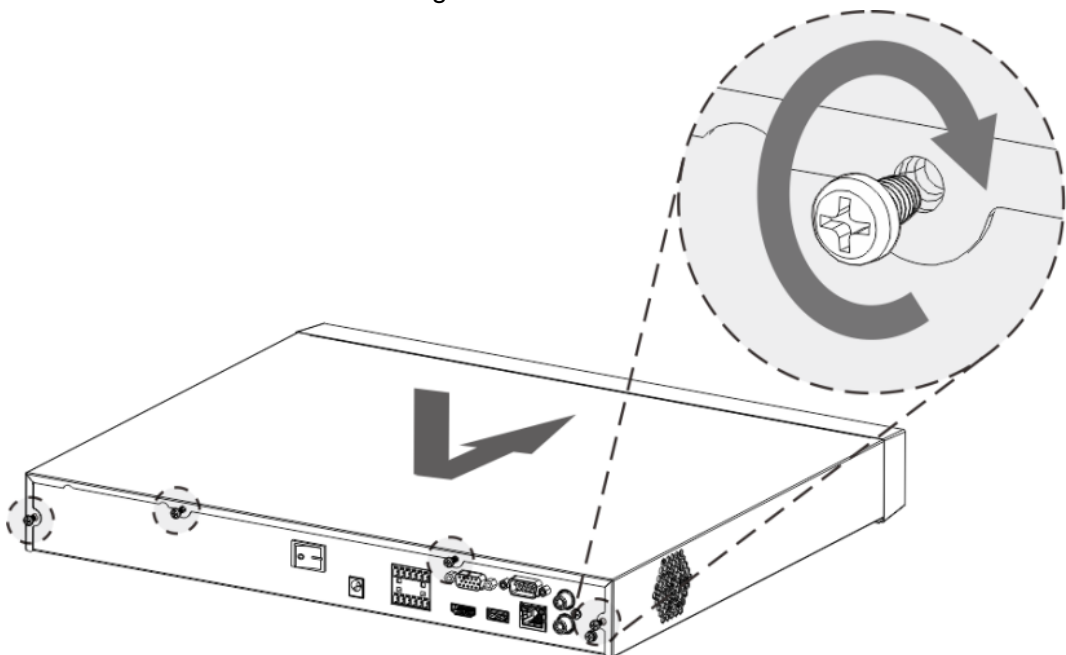

3.5 CD-ROM Installation

Procedure

Step 1 Open the top cover and then remove the HDD bracket.

Figure 3-18



Step 2 Take off the bottom of the HDD bracket and CD-ROM bracket.

Figure 3-19



Figure 3-20



Step 3 Fix the CD-ROM bracket at the HDD bracket.

Figure 3-21



Step 4 Install a pair of the CD-ROM bracket. Please make sure that the reverse side is secure too.

Figure 3-22



Figure 3-23



Step 5 Install SATA burner. Line up the SATA burner to the hole positions.

Figure 3-24



Step 6 Use screw driver to fix the screws.

Figure 3-25



Step 7 Put the bracket back. Please adjust the CD-ROM to the proper position so that the button of the front panel is directly facing the pop-up button of the CD-ROM.

Figure 3-26



Step 8 Connect the SATA cable and power wire.

Figure 3-27

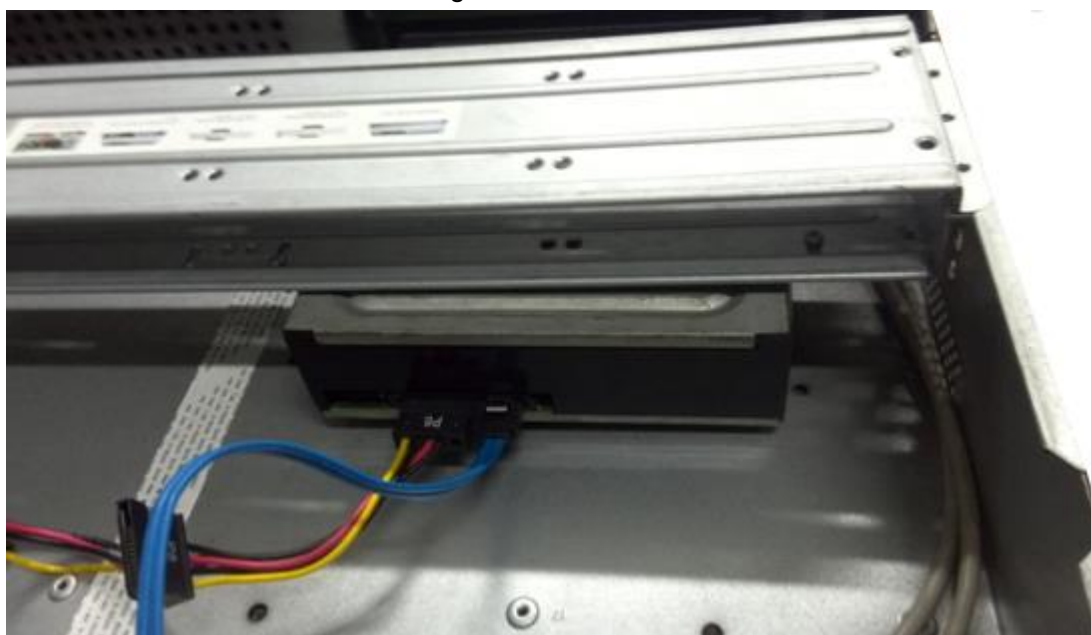

Step 9 Secure the HDD bracket and put the top cover back.

Figure 3-28



3.6 Connection Sample

Figure 3-29 IVD connection sample

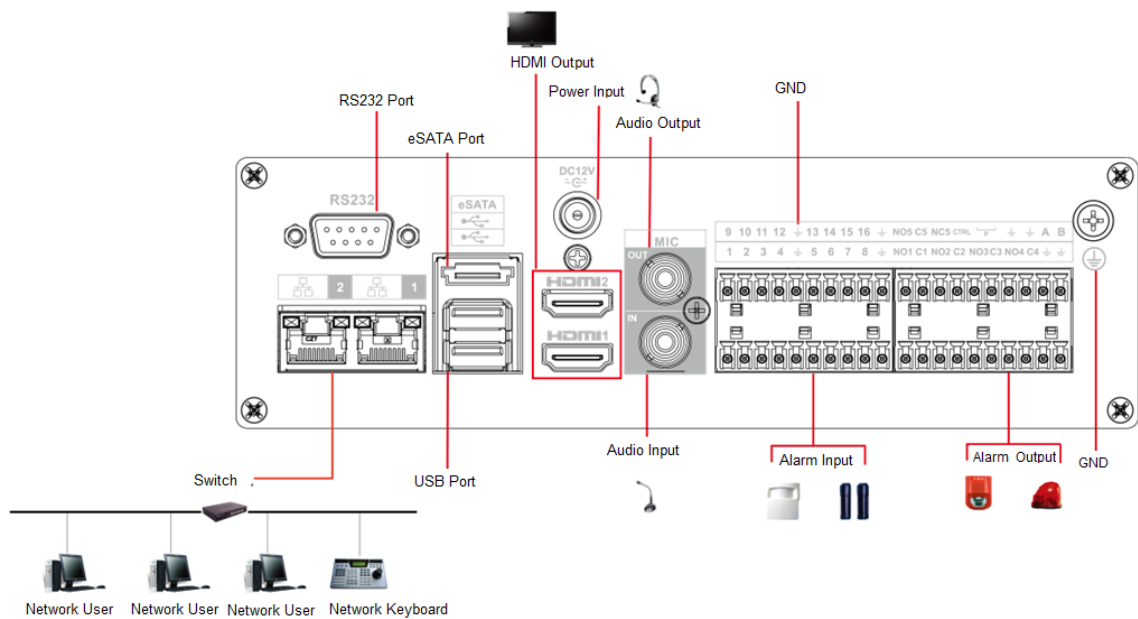

3.6.1 NVR58-I/4832-I Series

Background Information



The following figure is for reference only. The actual product shall prevail.

Figure 3-30

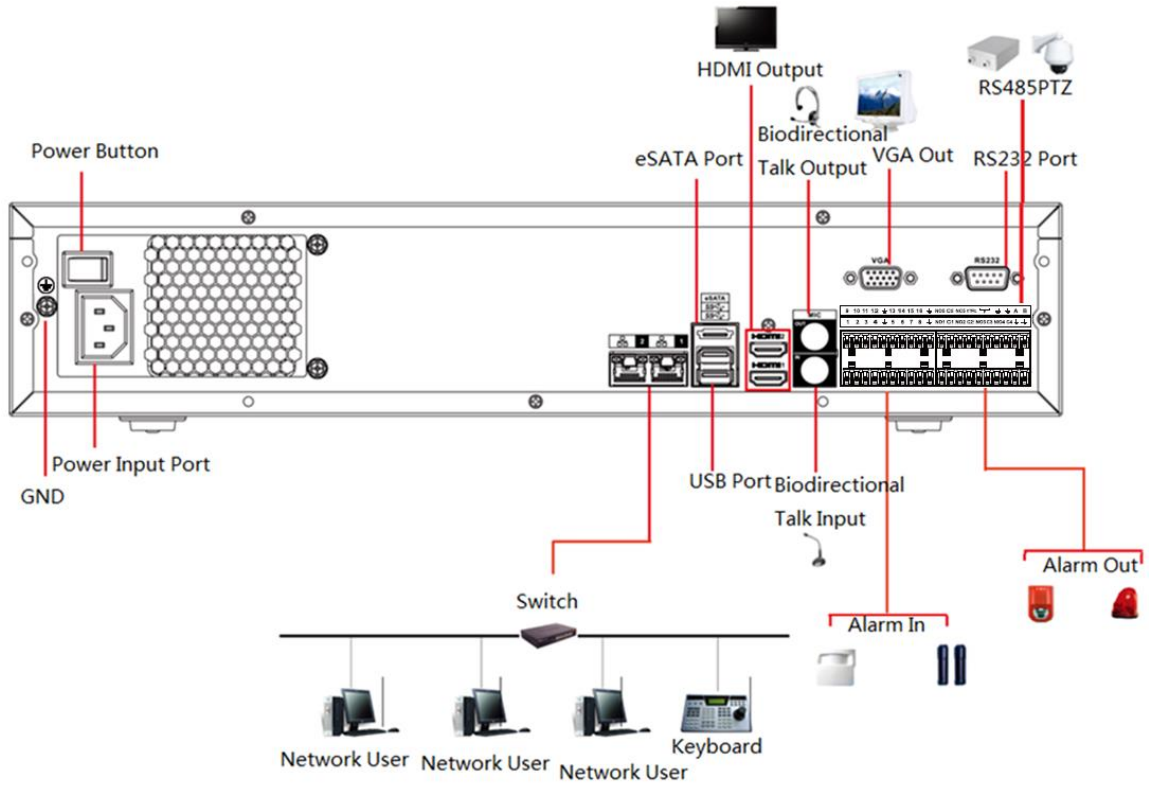

3.6.2 NVR54-16P-I/4416-16P-I/4432-I



The following figure is for reference only. The actual product shall prevail.

Figure 3-31

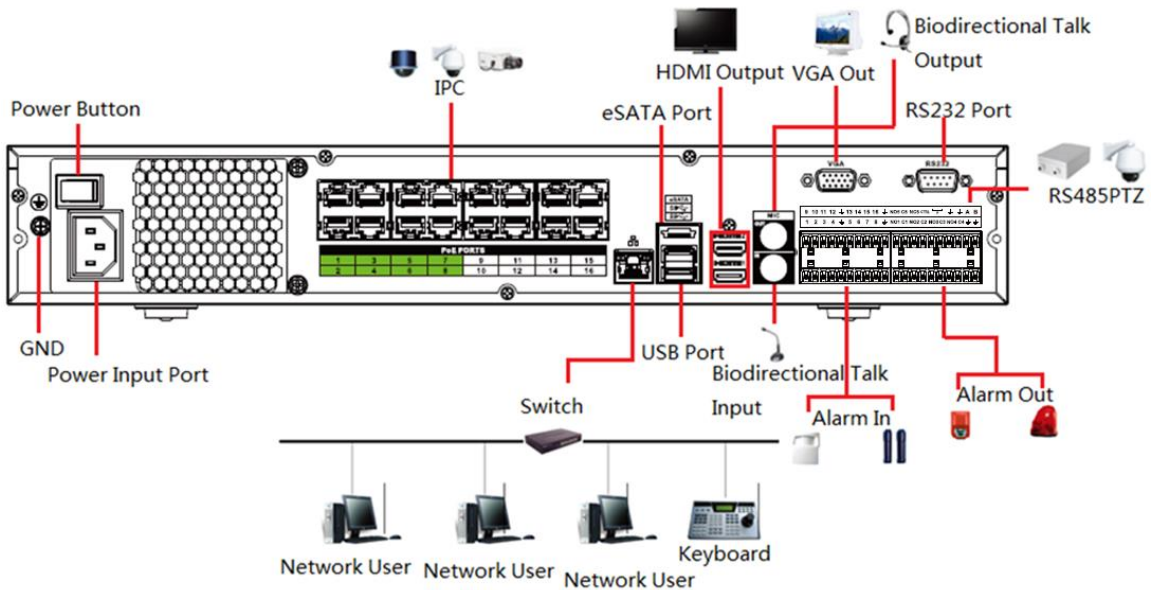

3.6.3 NVR52-16P-I/52-8P-I/4216-16P-I/4208-8P-I/4216-I Series



The following figure is for reference only. The actual product shall prevail.

Figure 3-32

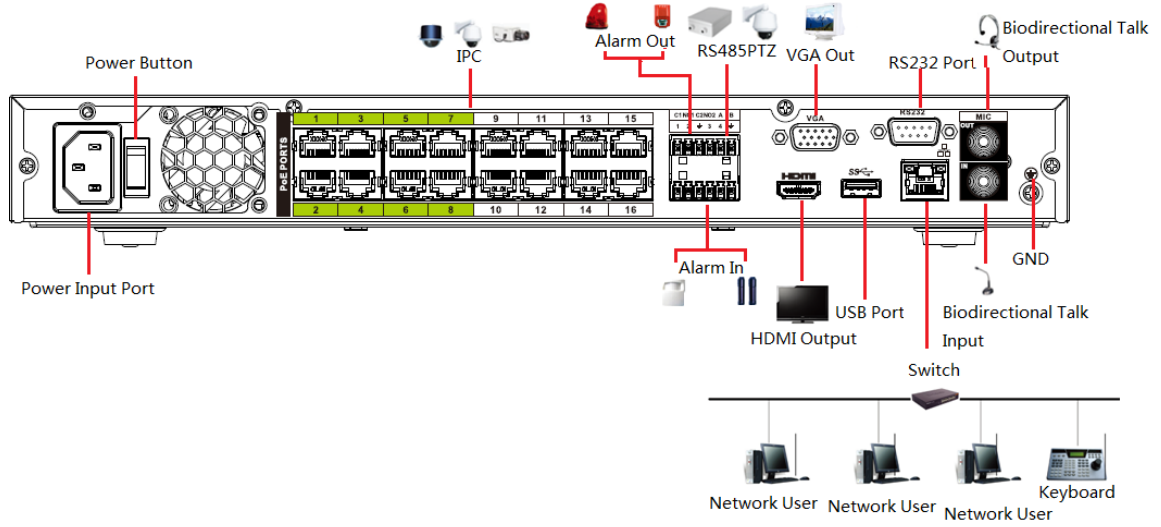

4 Local Basic Operation



Slight difference may be found on the user interface. The following figures are for reference only.

4.1 Getting Started

This chapter introduces device initial settings such as boot up, device initialization, reset password, and quick settings.

4.1.1 Booting up

Background Information



- For device security, connect the NVR to the power adapter first and then connect the device to the power socket.
- The rated input voltage matches the device power button. Make sure the power wire connection is OK. Then click the power button.
- Always use the stable current, if necessary UPS is a best alternative measure.

Procedure

- Step 1 Connect the device to the monitor and then connect a mouse.
- Step 2 Connect power cable.
- Step 3 Click the power button at the front or rear panel and then boot up the device.
After device booted up, the system is in multiple-channel display mode by default.



The device will verify license during booting up. If the verification failed, the following icon will be shown on the screen, contact the after-sale service for further information. This function is available on select models.

Figure 4-1 License failure warning



4.1.2 Device Initialization

Background Information

If it is your first time to use the device, set a login password of **admin** (system default user). You can select to use unlock pattern to login as needed.



For your device safety, keep your login password of **admin** well after the initialization steps, and change the password regularly.

Step 1 Boot up NVR.

The **Device Initialization** interface is displayed. See Figure 4-2

Figure 4-2 Set time zone and system time

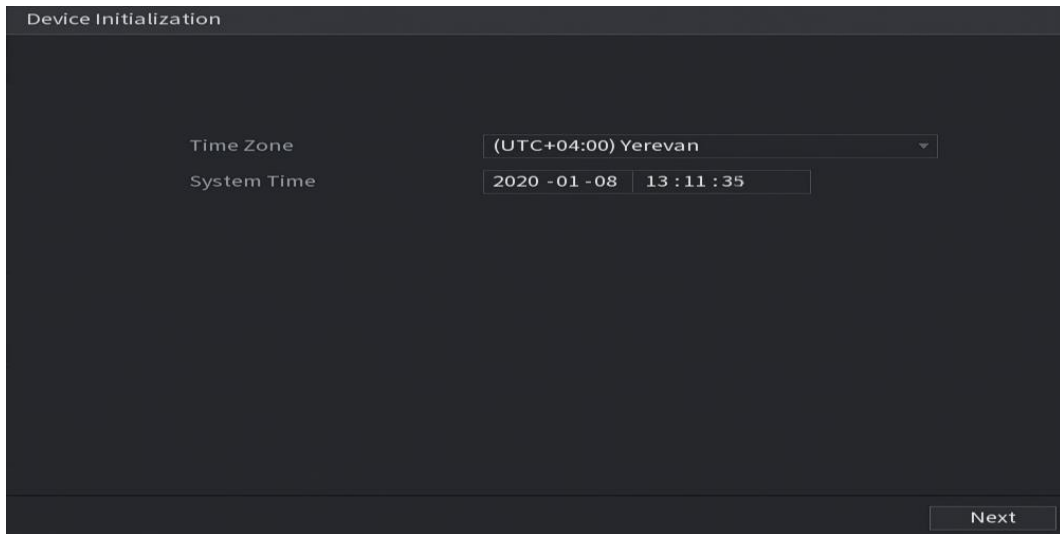

Step 2 Set system time zone according to the actual environment. Refer to Table 4-4 for detailed information.



Click to shut down the device. It is suitable for the system integrator or the user to shut down directly after setting the time zone.

Step 3 Click **Next**.

The **Device Initialization** interface is displayed. See Figure 4-3.

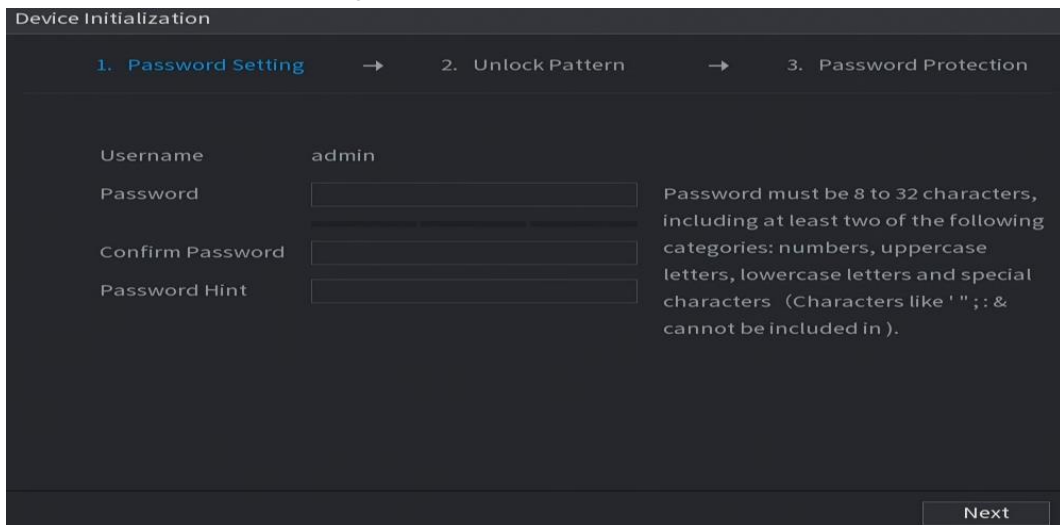

Figure 4-3 Set password



Step 4 Set login password of **admin**. See Table 4-1.

Table 4-1 Password parameters

Parameter	Description
User	By default, the user is admin.
Password	In the Password box, enter the password for admin.
Confirm Password	The new password can be set from 8 characters through 32 characters and contains at least two types from number, letter and special characters (excluding "", "", ";", ":" and "&").

Parameter	Description
Prompt Question	<p>In the Prompt Question box, enter the information that can remind you of the password.</p> <p></p> <p>On the login interface, click , the prompt will display to help you reset the password.</p>



For your device own safety, create a strong password of your own choosing. We also recommend you change your password periodically especially in the high security system.

Step 5 Click **Next**.

The **Unlock Pattern** interface is displayed. See Figure 4-4.

Figure 4-4 Draw unlock pattern

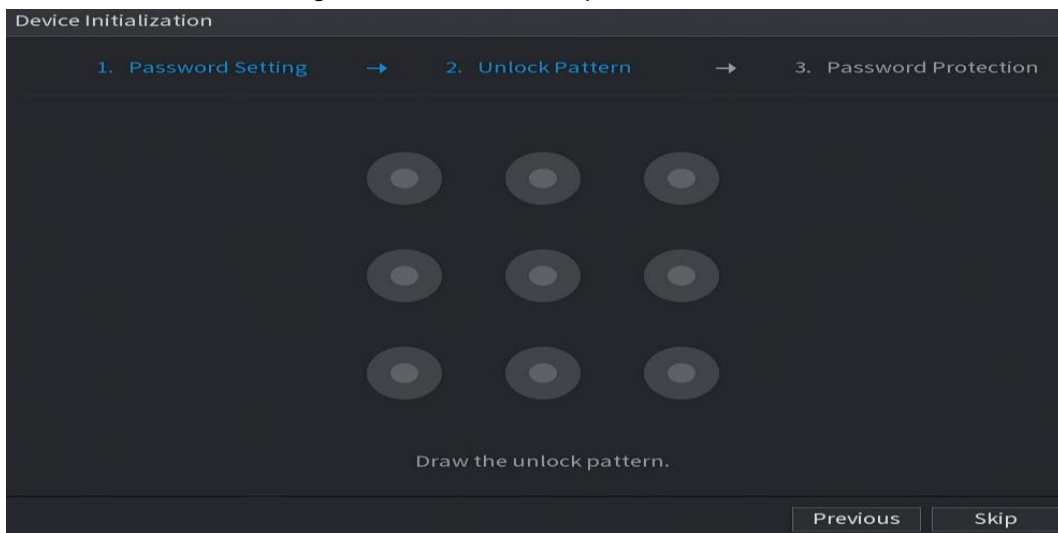

Step 6 Set unlock pattern.

After set unlock pattern, the **Password Protection** interface is displayed. See Figure 4-5.



- The pattern that you want to set must cross at least four grids.
- If you do not want to configure the unlock pattern, click **Skip**.
- Once you have configured the unlock pattern, the system will require the unlock pattern as the default login method. If you skip this setting, enter the password for login.

Figure 4-5 Set password protection

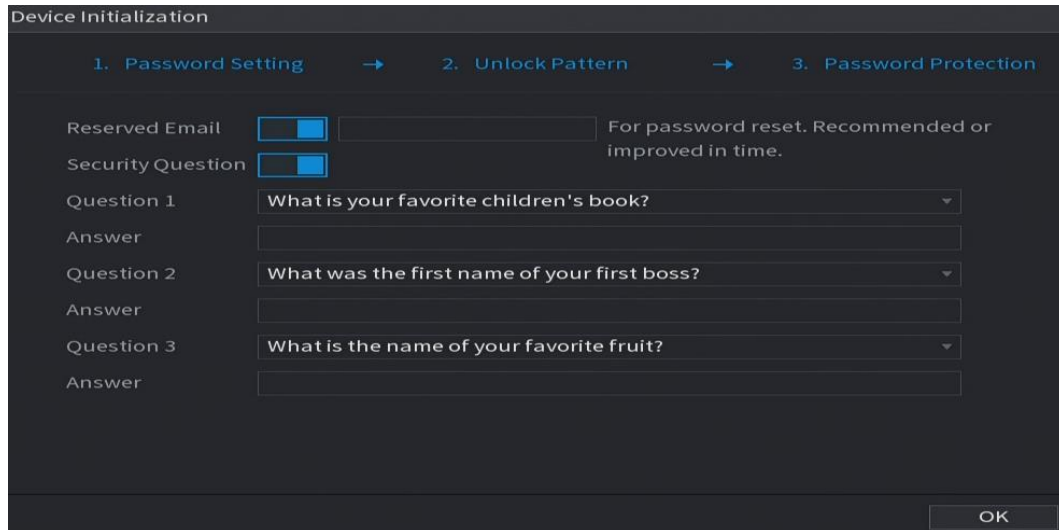

Step 7 Set security questions. See Table 4-2.

- After configuration, if you forgot the password for admin user, you can reset the password through the reserved email address or security questions. For details about resetting the password, see "4.1.3 Resetting Password".
- If you do not want to configure the settings, disable the email address and security questions functions on the interface.

Table 4-2 Security question parameters

Password Protection Mode	Description
Email Address	Enter the reserved email address. In the Email Address box, enter an email address for password reset. If you forget the password, enter the security code that you will get from this reserved email address to reset the password of admin. Refer to "4.15.1.2 Modify Password" for detailed information.
Security Questions	Configure the security questions and answers. If you forget the password, enter the answers to the questions can allow you reset the password. Refer to "4.15.3 Reset Password" for detailed information.

Step 8 Click **Save** to complete the device initialization setup.

Step 9 Device goes to startup wizard interface. Refer to "4.1.4 Quick Settings" for detailed information.

4.1.3 Resetting Password

Background Information

You can reset the password by the following methods when you forgot the password for admin account.

- If the password reset function is enabled, you can use mobile phone to scan the QR code to reset the password. For details, see "4.1.3.2 Resetting Password on Local Interface".
- If the password reset function is disabled, there are two situations:
 - ◇ If you configured security questions, you can reset the password by the security questions.
 - ◇ If you did not configure the security questions, you can only use the reset button on the mainboard to restore the Device to factory default.



Reset button is for some series product only.

4.1.3.1 Enabling Password Reset Function

Background Information

After enabling password reset function, you can scan QR code on the local menu to reset password.

Procedure

- Step 1** Select **Main Menu > ACCOUNT > Password Reset**.
The **Password Reset** interface is displayed. See Figure 4-6.

Figure 4-6 Password reset

Password Reset
 Enable
 Reserved Email
 Security Question
 Admin password can be found after setting security questions.
 Question 1:
 Answer:
 Question 2:
 Answer:
 Question 3:
 Answer:
 Apply Back

- Step 2** Check the box to enable reset function.



This function is enabled by default.

Step 3 Click **Apply** to set settings.

If the password reset function is disabled, you can follow the ways listed below to reset password.

- Device supports Reset button on the main board: You can answer the security question on the local menu or click the Reset button on the main board to reset password. Refer to "4.1.3.3 Reset Button" for detailed information.
- Device does not support Reset button on the main board: You can only answer the security question on the local menu to reset password. (Make sure you have set security questions).

4.1.3.2 Resetting Password on Local Interface

Procedure

Step 1 Enter the **Login** interface.

- If you have configured unlock pattern, the unlock pattern login interface is displayed. See Figure 4-7. Click **Forgot Pattern**, the password login interface is displayed. See Figure 4-8.
- If you did not configure unlock pattern, the **Login** interface is displayed. See Figure 4-8.



To log in from other user account, on the unlock pattern login interface, click **Switch User**, or on the password login interface, in the **Switch User** list, select other user to login.

Figure 4-7

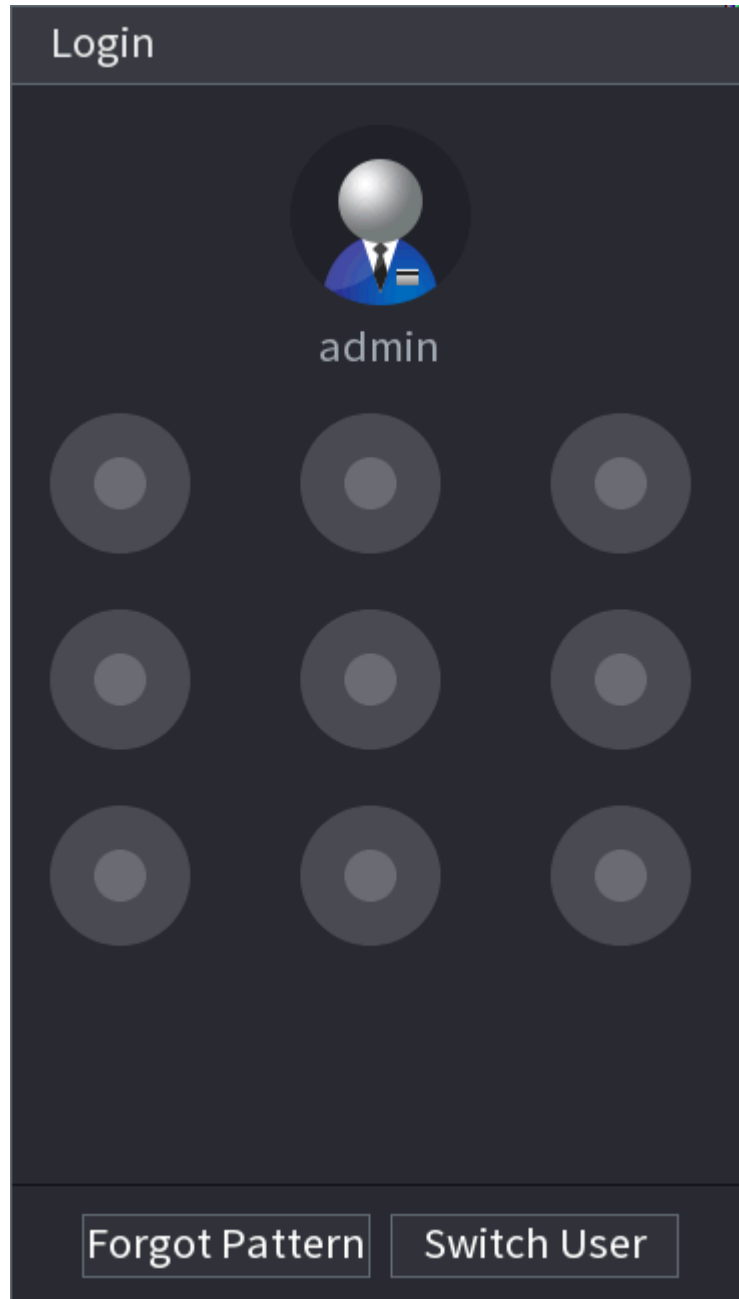
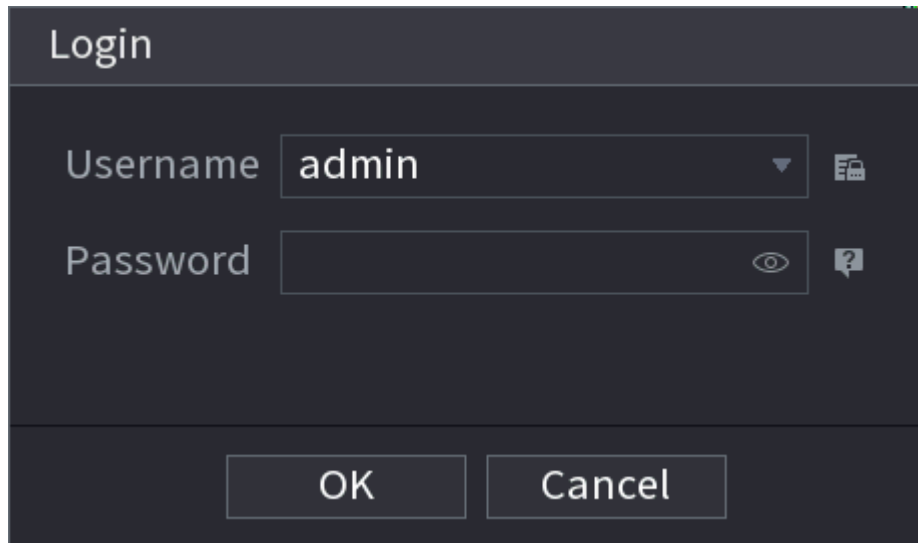



Figure 4-8

A dark-themed login dialog box titled "Login". It contains two input fields: "Username" with the text "admin" and a dropdown arrow, and "Password" which is empty. To the right of the Username field is a copy icon, and to the right of the Password field are an eye icon and a question mark icon. At the bottom of the dialog are two buttons: "OK" and "Cancel".

Step 2 Click .

- If you have set the reserved email address, the **Prompt** interface is displayed. See Figure 4-9. Click **OK**.
- If you did not set the reserved email address, the email entering interface is displayed. See Figure 4-8. Enter the email address.

Figure 4-9

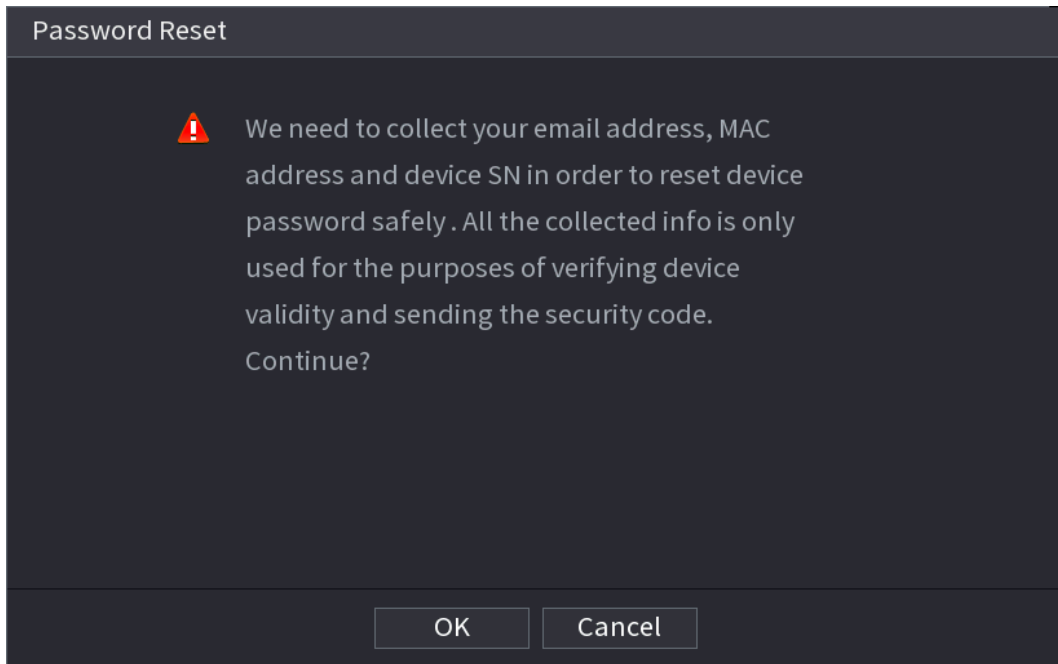
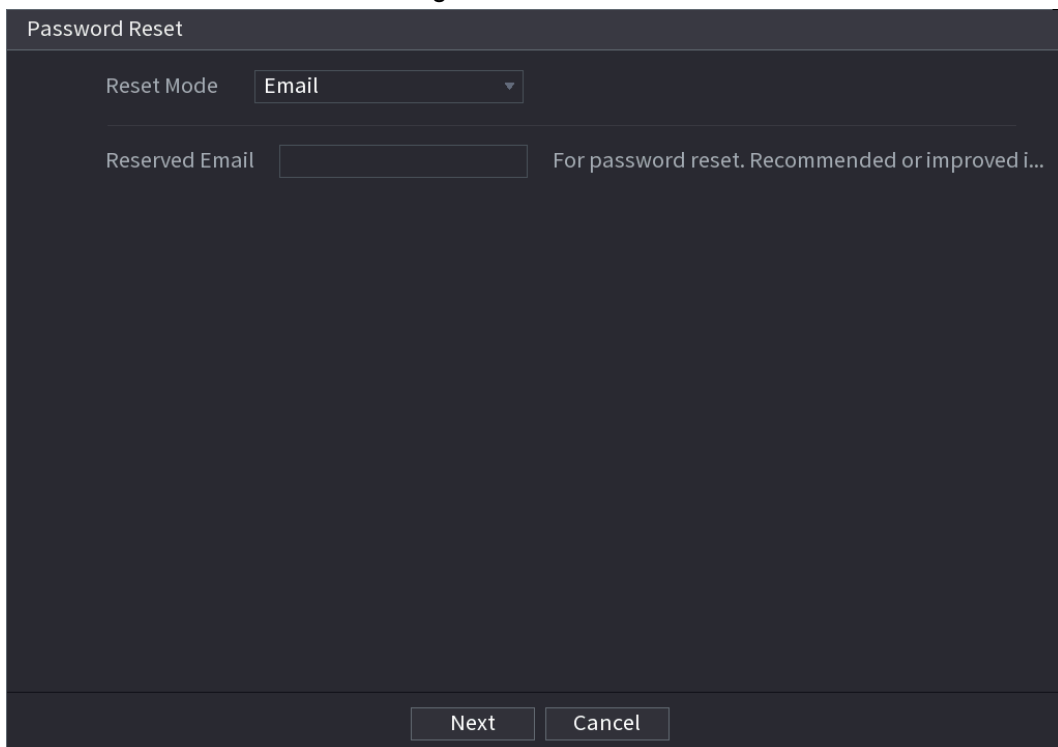

Figure 4-10



Step 3 Click **Next**.



After clicking **Next**, the system will collect your information for password reset, purpose and the information includes but not limited to email address, MAC address, and device serial number. Read the prompt carefully before clicking **Next**.

Step 4 Select a reset mode to reset the password. See Figure 4-11.

- Email
 - ◇ On the **Password Reset** interface as shown below, in the **Reset Mode** list, select **Email**. See Figure 4-11.

Figure 4-11

Password Reset

Reset Mode Email

SN: 3L*****ZC261B

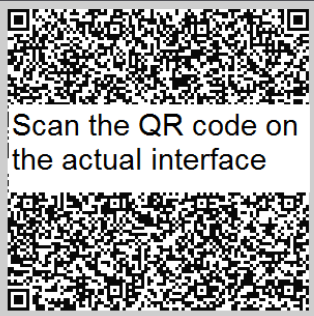

Scan the QR code on the actual interface

Note (For admin only):

Option 1. Please download and use DMSS, go to Me -> Password Security -> Reset Device Password and scan the left QR code.

Option 2. Please use any APP with scanning and recognition function, scan the left QR code to get encryption strings. And then send the strings to support_rpwd@global.dahuatech.com.

The security code will be delivered to 2***@QQ.COM.

Security Code

Next
Cancel

- ◇ Follow the on-screen instruction to acquire the security code from email.
- ◇ Enter security code and click **Next**.
- Security question
 - On the **Password Reset** interface as shown below, in the **Reset Mode** list, select **Security Question**, the Security Questions interface is displayed. See Figure 4-12.



If you did not configure the security questions before, in the **Reset Type** list, there is no **Security Question**.

Figure 4-12

The screenshot shows a 'Password Reset' dialog box with a dark background. At the top, it says 'Password Reset'. Below that, there is a 'Reset Mode' dropdown menu set to 'Security Question'. There are three question-and-answer pairs. Each pair consists of a question label (e.g., 'Question 1'), a dropdown menu with a question (e.g., 'What is your favorite children's book?'), and an empty text input field labeled 'Answer'. At the bottom of the dialog, there are two buttons: 'Next' and 'Cancel'.

Step 5 Click **Next**.

The **Reset Password** interface is displayed. See Figure 4-13.

Figure 4-13

The screenshot shows a 'Password Reset' dialog box with a dark background. It says 'Reset the password of (admin)'. There are two text input fields: 'New Password' and 'Confirm Password'. Below the 'New Password' field, there is a password strength indicator (a bar with segments) and a text description: 'Password must be 8 to 32 characters, including at least two of the following categories: numbers, uppercase letters, lowercase letters and special characters (Characters like ' ' ; : & cannot ...'. At the bottom of the dialog, there are two buttons: 'OK' and 'Cancel'.

Step 6 In the **New Password** box, enter the new password and enter it again in the **Confirm Password** box.

- Step 7 Click **OK**. The password resetting is complete.
- Step 8 (Optional) Click **OK** to synchronize password to remote devices.

Figure 4-14

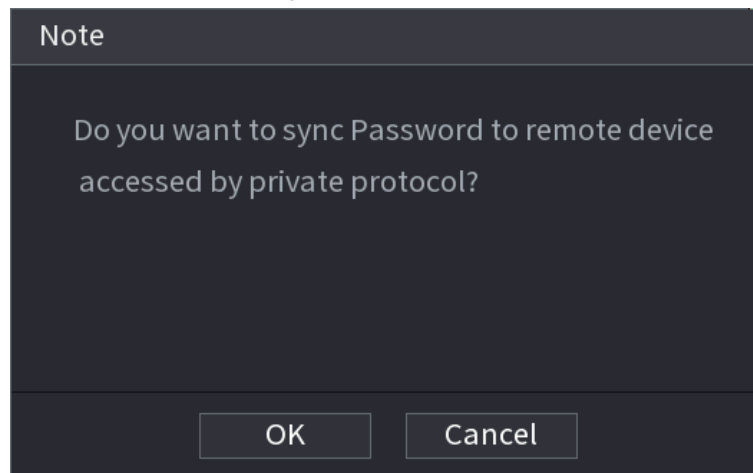

4.1.3.3 Reset Button

Background Information

You can always use the reset button on the mainboard to reset the Device to the factory default settings.



Reset button is for select models only.

Procedure

- Step 1 Disconnect the Device from power source, and then remove the cover panel. For details about removing the cover panel, see "3.4 HDD Installation".
- Step 2 Find the reset button on the mainboard, and then connect the Device to the power source again.
- Step 3 Press and hold the reset button for 5 seconds to 10 seconds. See Figure 4-15 for the location of the reset button.

Figure 4-15

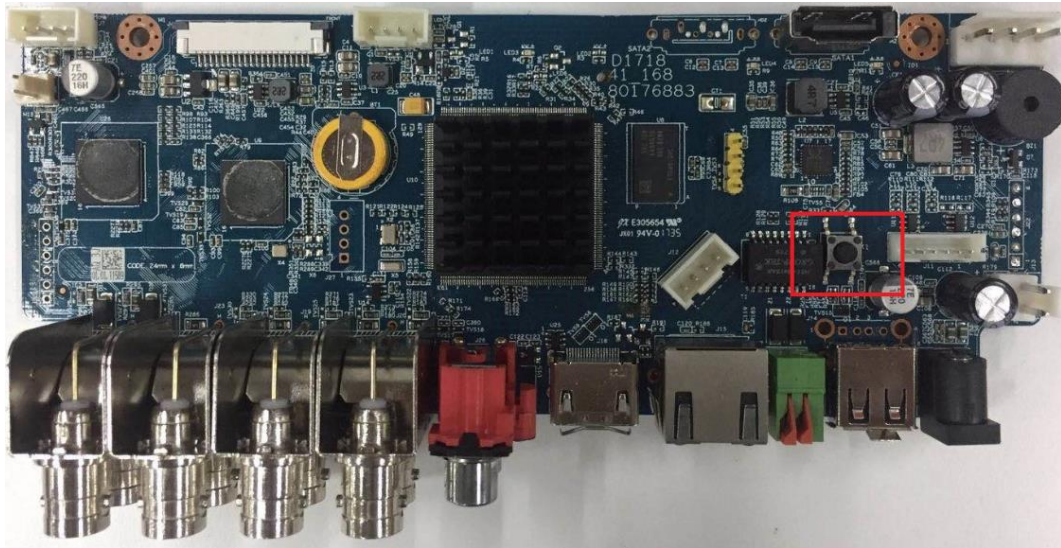

Step 4 Restart the Device.

After the Device is restarted, the settings have been restored to the factory default. You can start resetting the password.

4.1.4 Quick Settings

After you successfully initialized the device, it goes to startup wizard. Here you can quickly configure your device. Click **Next**, the device goes to **General** interface.



The startup wizard interface only displays after you first login the device and have set the admin password. See Figure 4-16.

Figure 4-16 Startup wizard

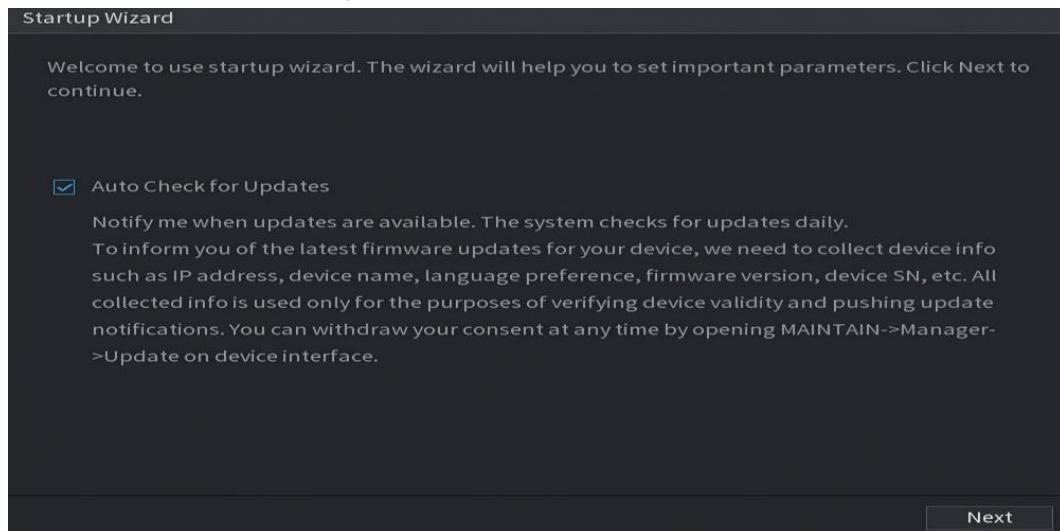

- If you select the **Auto Check for Updates** check box, the system will notify you automatically when updates are available.
- After the auto-check function is enabled, to notify you to update timely, the system will collect the information such as IP address, device name, firmware version, and device serial number. The collected information is only used to verify the legality of the Device and push upgrade notices.
- If you cancel the **Auto Check for Updates** check box, the system will not perform automatic checks.

4.1.4.1 General

You can set NVR basic information such as system date and holiday.

4.1.4.1.1 General

Background Information

You can set device basic information such as device name, serial number..

Step 1 Select **Main Menu > SYSTEM > General > Basic**.

Figure 4-17 Basic settings

Step 2 Set parameters. See Table 4-3.

Table 4-3 Basic parameters

Parameter	Description
Device Name	Enter the Device name.
Device No.	Enter a number for the Device.
Language	Select a language for the Device system.
Video Standard	Select PAL or NTSC as needed.
Sync Remote Device	Enable this function; the NVR can synchronize information with the remote device such as Language, video standard and time zone.
Instant Playback	In the Instant Play box, enter the time length for playing back the recorded video. The value ranges from 5 to 60. On the live view control bar, click the instant playback button to play back the recorded video within the configured time.
Logout Time	Enter the standby time for the Device. The Device automatically logs out when it is not working in the configured period. You need to login the Device again. The value ranges from 0 to 60. 0 indicates there is not standby time for the Device. Click Monitor Channel(s) when logout . You can select the channels that you want to continue monitoring when you logged out.
CAM Time Sync	Syncs the Device time with IP camera.
Interval	Enter the interval for time sync.
Logout Time	You can set auto logout interval once login user remains inactive for a specified time. Value ranges from 0 to 60 minutes.

Parameter	Description
Navigation Bar	Enable the navigation bar. When you click on the live view screen, the navigation bar is displayed.
Mouse Sensitivity	Adjust the speed of double-click by moving the slider. The bigger the value is, the faster the speed is.

Step 3 Click **Apply** button to save settings.

4.1.4.1.2 Date and Time

Background Information

You can set device time. You can enable NTP (Network Time Protocol) function so that the device can sync time with the NTP server.

You can also configure date and time settings by selecting **Main Menu > SYSTEM > General > Date&Time**.

Step 1 Click **Date&Time** tab. See Figure 4-18.

Figure 4-18 Date and time

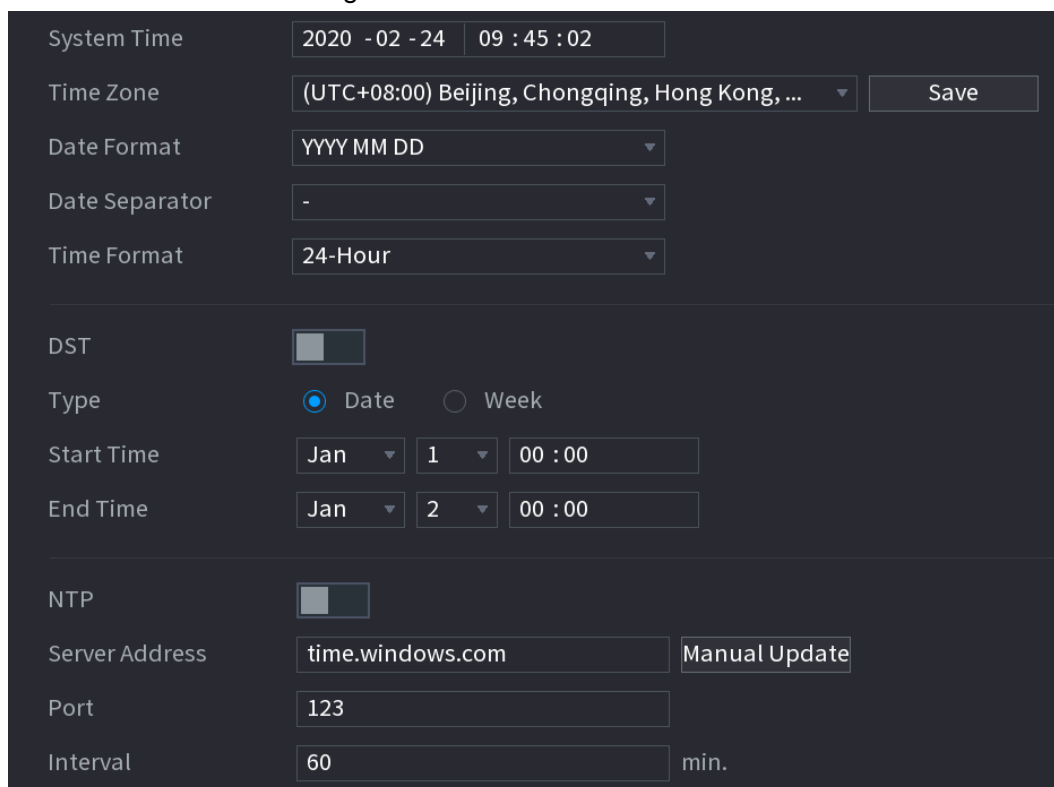



The screenshot shows the following configuration options:

- System Time:** 2020 -02 -24 09 : 45 : 02
- Time Zone:** (UTC+08:00) Beijing, Chongqing, Hong Kong, ... (with a Save button)
- Date Format:** YYYY MM DD
- Date Separator:** -
- Time Format:** 24-Hour
- DST:** Disabled (toggle switch)
- Type:** Date (selected), Week
- Start Time:** Jan 1 00 : 00
- End Time:** Jan 2 00 : 00
- NTP:** Disabled (toggle switch)
- Server Address:** time.windows.com (with Manual Update button)
- Port:** 123
- Interval:** 60 min.

Step 2 Configure the settings for date and time parameters. See Table 4-4.

Table 4-4 Data and time parameters

Parameter	Description
System Time	<p>In the System Time box, enter time for the system.</p> <p>Click the time zone list, you can select a time zone for the system, and the time in adjust automatically.</p>  <p>Do not change the system time randomly; otherwise the recorded video cannot be searched. It is recommended to avoid the recording period or stop recording first before you change the system time.</p>
Time Zone	In the Time Zone list, select a time zone for the system.
Date Format	In the Date Format list, select a date format for the system.
Date Separator	In the Date Separator list, select a separator style for the date.
Time Format	In the Time Format list, select 12-HOUR or 24-HOUR for the time display style.
DST	Enable the Daylight Saving Time function. Click Week or Date .
Start Time	Configure the start time and end time for the DST.
End Time	
NTP	<p>Enable the NTP function to sync the Device time with the NTP server.</p>  <p>If NTP is enabled, device time will be automatically synchronized with server.</p>
Server Address	<p>In the Server Address box, enter the IP address or domain name of the corresponding NTP server.</p> <p>Click Manual Update, the Device starts syncing with the server immediately.</p>
Port	The system supports TCP protocol only and the default setting is 123.
Interval	In the Interval box, enter the amount of time that you want the Device to sync time with the NTP server. The value ranges from 0 to 65535.

Step 3 Click **Next** to save settings.

4.1.4.1.3 Holiday

Background Information

Here you can add, edit, and delete holiday. After you successfully set holiday information, you can view holiday item on the record and snapshot period.

You can also configure holiday settings by selecting **Main Menu > SYSTEM > General > Holiday**.

Procedure

Step 1 Click **Next**.

The **Holiday** interface is displayed. See Figure 4-19.

Figure 4-19 Holiday

0	Status	Name	Date	Duration	Operation

Step 2 Click **Add Holidays**, the **Add Holidays** interface is displayed. See Figure 4-20.

Figure 4-20 Add holidays

Add

Name

Effective Mode Once Always

Period Date Week

Start Time

End Time

Add More



Step 3 Set holiday name, repeat mode and holiday mode.



Click **Add more** to add new holiday information.

Step 4 Click **Add**, you can add current holiday to the list.



- Click the drop-down list of the state; you can enable/disable holiday date.
- Click  to change the holiday information. Click  to delete current date.

Step 5 Click **Next** to save settings.

4.1.4.2 Basic Networking Settings

Background Information

You can set device IP address, DNS (Domain Name System) information. You can also configure basic network settings by selecting **Main Menu > NETWORK > TCP/IP**.



Make sure that the device has properly connected to the network.

Procedure

Step 1 Click **Next**.

The **TCP/IP** interface is displayed. See Figure 4-21.



Ethernet adapter amount and type may vary model to model, and the actual product shall prevail.

Figure 4-21 TCP/IP

NIC Name	IP Address	Network ...	NIC Member	Modify	Unbind
NIC1		Single NIC	1		

IP Address: [] Default Gateway: [] MTU: 1500
MAC Address: [] Subnet Mask: [] Mode: Static

IP Version: IPv4 DHCP

Preferred DNS: [] . [] . [] . []
Alternate DNS: [] . [] . [] . []

Default Card: NIC1

Virtual Host:

Step 2 Click

The **Modify** interface is displayed. See Figure 4-22

Figure 4-22 Modify IP



The screenshot shows a 'Modify' dialog box for IP configuration. The fields are as follows:

NIC Name	NIC1
Network Mode	<input checked="" type="radio"/> Single NIC
IP Version	IPv4
DHCP	<input type="checkbox"/>
MAC Address	[Input field]
IP Address	[Input field] [Test]
Subnet Mask	[Input field]
Default Gateway	[Input field]
MTU	1500

Buttons: OK, Cancel

Step 3 Set parameters. See Table 4-5

Table 4-5 Network parameters (1)

Parameter	Description
Network Mode	<ul style="list-style-type: none"> ● Multi-address: Two Ethernet ports work separately through either of which you can request the Device to provide the services such as HTTP and RTSP. You need to configure a default Ethernet port (usually the Ethernet port 1 by default) to request the services from the device end such as DHCP, email and FTP. If one of the two Ethernet ports is disconnected as detected by networking testing, the system network status is regarded as offline. ● Fault Tolerance: Two Ethernet ports share one IP address. Normally only one Ethernet port is working and when this port fails, the other port will start working automatically to ensure the network connection. <p></p> <p>When testing the network status, the network is regarded as offline only when both of the two Ethernet ports are disconnected. The two Ethernet ports are used under the same LAN.</p> <ul style="list-style-type: none"> ● Load Balance: Two network cards share one IP address and they are working at the same time to share the network load averagely. If one of them fails, the other can continue working normally. <p></p> <p>When testing the network status, the network is regarded as offline only when both of the two Ethernet ports are disconnected. The two Ethernet ports are used under the same LAN.</p> <p></p> <p>The Device with single Ethernet port does not support this function.</p>
Default Ethernet Port	<p>In the Ethernet Card list, select an Ethernet port as a default port.</p> <p>This setting is available only when the Multi-address is selected in the Net Mode list.</p>
IP Version	<p>In the IP Version list, you can select IPv4 or IPv6. Both versions are supported for access.</p>
MAC Address	<p>Displays the MAC address of the Device.</p>

Parameter	Description
DHCP	<p>Enable the DHCP function. The IP address, subnet mask and default gateway are not available for configuration once DHCP is enabled.</p> <ul style="list-style-type: none"> • If DHCP is effective, the obtained information will display in the IP Address box, Subnet Mask box and Default Gateway box. If not, all values show 0.0.0.0. • If you want manually configure the IP information, disable the DHCP function first. • If PPPoE connection is successful, the IP address, subnet mask, default gateway, and DHCP are not available for configuration.
IP Address	<p>Enter the IP address and configure the corresponding subnet mask and default gateway.</p> <p> IP address and default gateway must be in the same network segment.</p>
Subnet Mask	
Default Gateway	
DNS DHCP	Enable the DHCP function to get the DNS address from router.
Preferred DNS	In the Preferred DNS box, enter the IP address of DNS.
Alternate DNS	In the Alternate DNS box, enter the IP address of alternate DNS.
Test	Click Test to test if the entered IP address and gateway are interworking.

Step 4 Click **OK** to go to NIC settings.

Step 5 Set network parameters. See Table 4-6.

Table 4-6 Network paramters (2)

Parameter	Description
IP Version	There are two options: IPv4 and IPv6. The system supports these two IP address format.
Preferred DNS server	DNS server IP address.
Alternate DNS server	DNS server alternate address.
MAC Address	Displays the MAC address of the Device.
DHCP	<p>Enable the DHCP function. The IP address, subnet mask and default gateway are not available for configuration once DHCP is enabled.</p> <ul style="list-style-type: none"> • If DHCP is effective, the obtained information will display in the IP Address box, Subnet Mask box and Default Gateway box. If not, all values show 0.0.0.0. • If you want manually configure the IP information, disable the DHCP function first. • If PPPoE connection is successful, the IP address, subnet mask, default gateway, and DHCP are not available for configuration.

Step 6 Click **Next**.

4.1.4.3 P2P

Background Information

Scan the QR code on the actual interface to download the cell phone app. Register an account and then you can use the smart phone to add the device.



Before using the P2P function, make sure that the NVR has connected to the WAN.

4.1.4.3.1 Local Operation

Step 1 Click **Next** button.

The **P2P** interface is displayed. See Figure 4-23.



Select **Main Menu > Network > P2P**, you can go to **P2P** interface too.

Figure 4-23 P2P

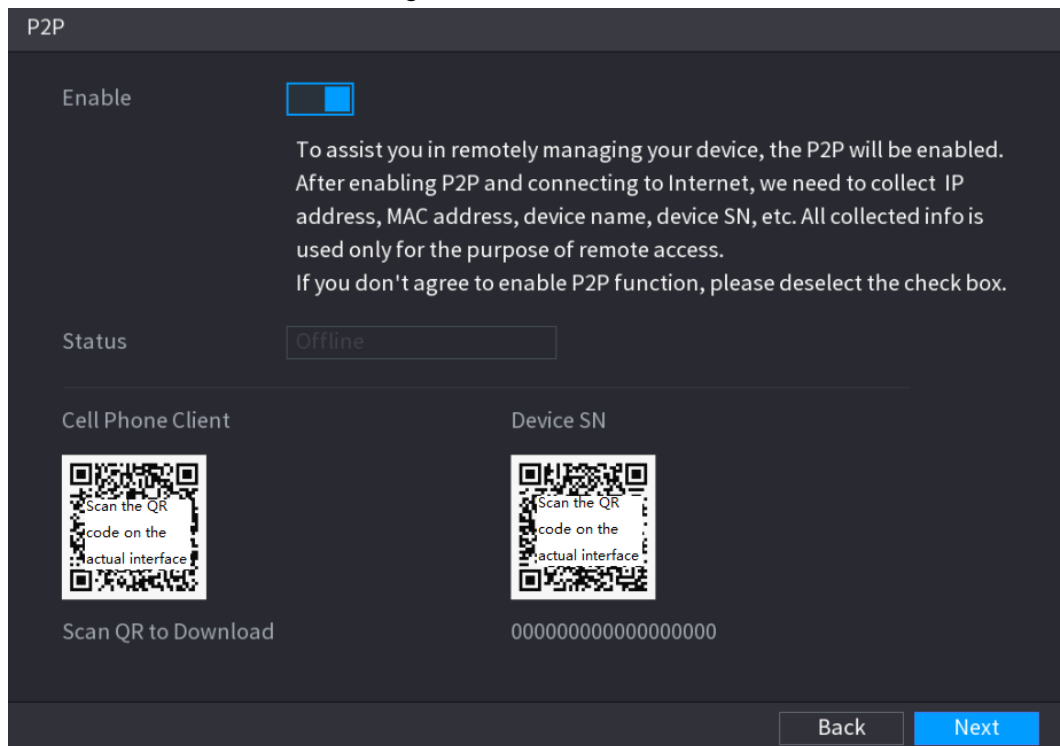

Step 2 Check the box to enable P2P function.



After the P2P function is enabled and connected to the Internet, the system will collect your information for remote access, and the information includes but not limited to email address, MAC address, and device serial number.

Step 3 Click **Next** button to complete setup.

The status is online if the P2P registration is successful.

4.1.4.3.2 Client Operation

Procedure

- Step 1 Use your smart phone to scan the QR code under Cell Phone Client to download the application.
- Step 2 On your smart phone, open the application, and then tap .
- Step 3 The menu is displayed. You can start adding the device.
- 1) Tap **Device Manager**.
The **Device Manager** interface is displayed. See Figure 4-24.

Figure 4-24 Device manager





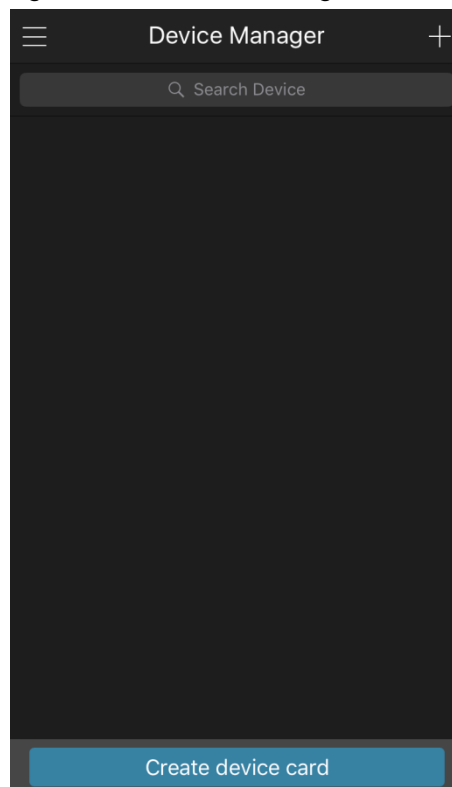

- 2) Tap  on the top right corner.
The interface requiring device initialization is displayed. A pop-up message reminding you to make sure the Device is initialized is displayed.
- 3) Tap **OK**.
 - If the Device has not been initialized, Tap **Device Initialization** to perform initializing by following the onscreen instructions.
 - If the Device has been initialized, you can start adding it directly.
- 4) Tap **Add Device**.

You can add wireless device or wired device. The manual takes adding wired device as an example.
- 5) Tap **P2P**.
The **P2P** interface is displayed. See Figure 4-25.

Figure 4-25

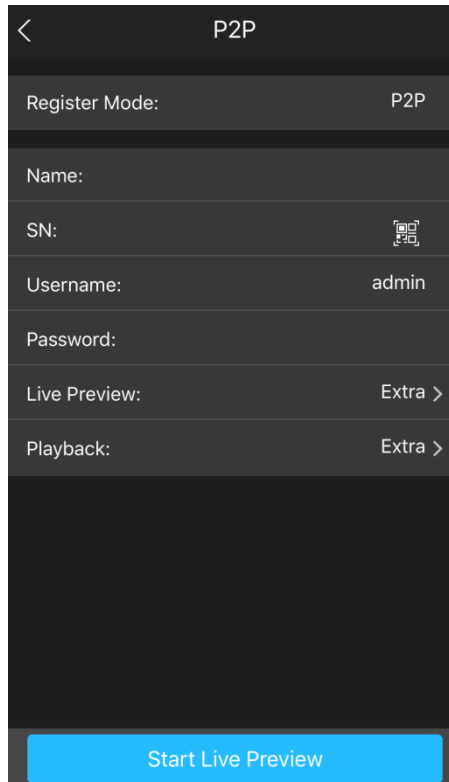

P2P	
Register Mode:	P2P
Name:	
SN:	
Username:	admin
Password:	
Live Preview:	Extra >
Playback:	Extra >
Start Live Preview	

- 6) Enter a name for the NVR, the username and password, scan the QR code under **Device SN**.
- 7) Tap **Start Live Preview**.
The Device is added and displayed on the live view interface of the cell phone.
See Figure 4-26.

Figure 4-26 Live view



4.1.4.4 Adding Camera

Background Information



If you do not select Smart add function during the initialization process, go to the remote Device interface to register a remote device.

After adding remote device, the device can receive, store, and manage the video streams of the remote device. You can view, browse, play back and manage several remote devices at the same time.

Procedure

- Step 1 On the **P2P** interface, click **Next**.
The **Camera List** interface is displayed. See Figure 4-27.



There are two ways to go to **Registration** interface.

- Select **Main Menu > CAMERA > Camera List > Camera List**, you can go to the **Camera List** interface.
- On the live view interface, right-click mouse and then select **Add Camera**.

Figure 4-27 Add camera

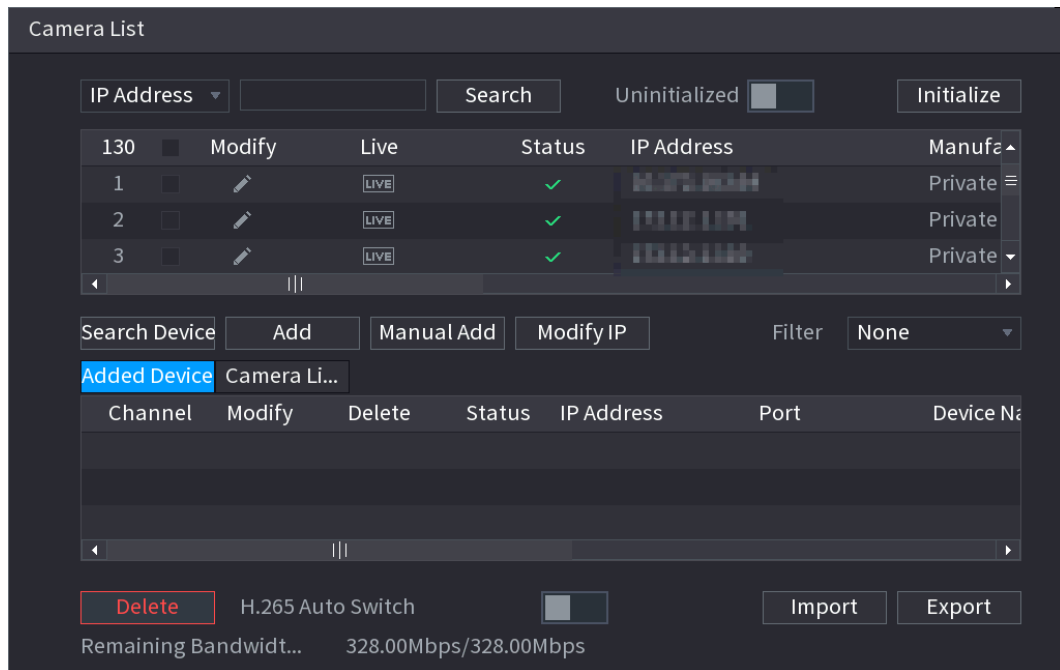

Step 2 Register remote device.

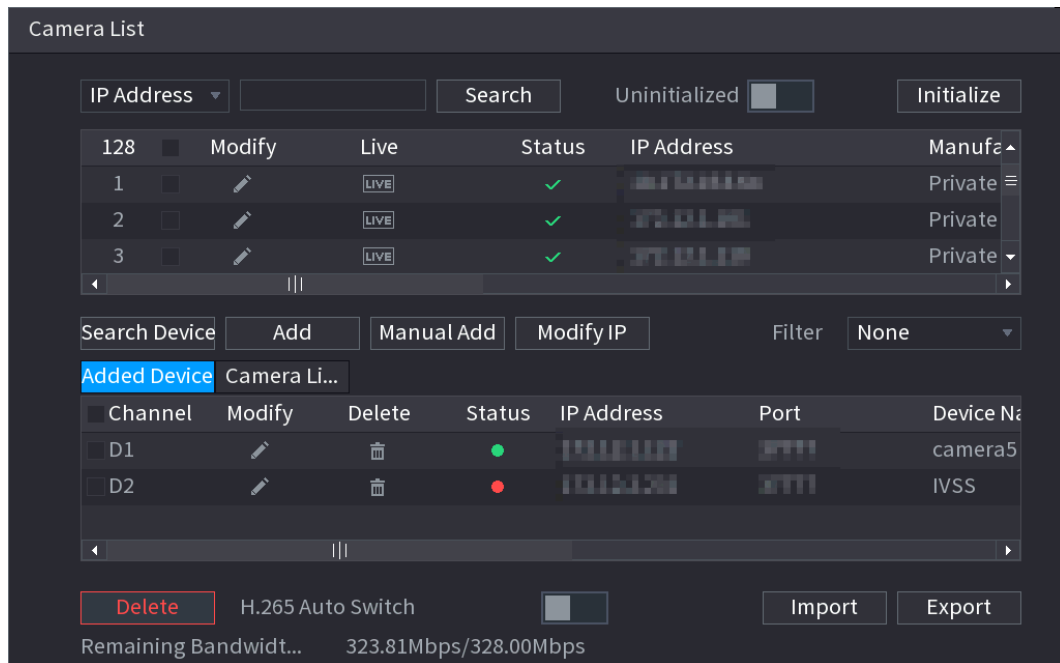

- Search and then add
 1. Click **Search**.
The devices found are displayed at the upper pane.
 2. Double-click a remote device, or select a remote device and then click **Add** to register it to the **Added Device** list. See Figure 4-28.

Figure 4-28 Search device

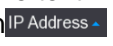

3. Set parameters. See Table 4-7.

Table 4-7 Camera list parameters

Parameter	Description
Uninitialized	Enable the Uninitialized function, the uninitialized devices out of the searched devices are displayed in the searched device list.
Initialize	Select the uninitialized device from the uninitialized device list, and the click Initialize to start initializing device.
Filter	In the Show Filter list, select the remote device type that you want to display in the searched device list. <ul style="list-style-type: none"> • None: Display all types of devices. • IPC: Display the front-end devices. • DVR: Display all storage devices such as NVR, DVR and HCVR. • OTHER: Display the devices that do not belong to IPC or DVR type.
Searched Device List	Displays the searched devices. You can view the device information such as status, IP address.
Search	Click Search , the searched devices display in the searched device list. To adjust the display sequence, in the title line, you can click the IP address, Manufacturer, Type, MAC Address, Port, or Device Name text. For example, click the IP address text, the sequence icon  is displayed.  "*" is displayed next to the added device.

Parameter	Description
Add	In the Searched Device List area, select the device that you want to add.
Manual Add	Add the device by manually configuring settings such as IP address, and channel selection.
Added Device List	Displays the added devices. You can edit and delete the device, and view the device information.
Delete	Select the check box of the added device, and then click Delete to delete the added device.
Import	Select the searched devices and then click Import to import the devices in batches.
Export	Select the added devices and then click Export . The exported devices information is saved into the USB storage device.

- Manual Add

- Click **Manual Add**.

The **Manual Add** interface is displayed. See Figure 4-29.

Figure 4-29 Manual add



The screenshot shows the 'Manual Add' configuration window. It contains the following fields and controls:

- Channel:** A dropdown menu with 'D3' selected.
- Manufacturer:** A dropdown menu with 'Private' selected.
- IP Address:** A text input field with '192.168.1.1' entered.
- TCP Port:** A text input field with '8080' entered.
- Username:** A text input field with 'admin' entered.
- Password:** A text input field (empty).
- Total Channels:** A text input field with '1' entered.
- Remote CH No.:** A dropdown menu with 'D1' selected.
- Decode Strategy:** A dropdown menu with 'General' selected.
- Buttons:** 'Connect' and 'Setting' buttons are located to the right of the Password and Total Channels fields, respectively.

- Configure parameters. See Table 4-8.

Table 4-8 Remote channel parameters

Parameter	Description
Channel	From the Channel drop-down list, select the channel that you want use on the Device to connect the remote device.
Manufacturer	From the Manufacturer drop-down list, select the manufacturer of the remote device.



Parameter	Description
IP Address	In the IP Address box, enter the IP address of the remote device.  The default is 192.168.0.0 which the system cannot connect to.
TCP Port	The default value is 37777. You can enter the value as needed.
User Name	Enter the user name of the remote device.
Password	Enter the password of the user for the remote device.
Remote CH No.	Enter the remote channel number of the remote device that you want to add.
Decoder Strategy	From the Decoder Strategy drop-down list, select Default , Realtime , or Fluent .
Protocol Type	<ul style="list-style-type: none"> • If the remote device is added through private protocol, the default type is TCP. • If the remote device is added through ONVIF protocol, the system supports Auto, TCP, UDP, or MULTICAST. • If the remote device is added through other manufacturers, the system supports TCP and UDP.
Encrypt	If the remote device is added through Onvif protocol, selecting the Encrypt check box will provide encryption protection to the data being transmitted.  To use this function, the HTTPS function should be enabled for the remote IP camera.

3. Click **OK**.

The remote device information is displayed on the **Added Device** list.

Step 3 Click **Next** to complete the remote device registration.



Click  to change the remote device information. Click  to delete remote device.

Once the multiple-sensor device has registered to the device, the system will display the channel status on the Link info. See Figure 4-30. It shows one remote device has occupied two channels: D1, D3.

Figure 4-30 Registration

The screenshot shows the 'REGISTRATION' interface. At the top, there are filters for 'Show Filter' (Null), 'Uninitialized' (checkbox), and 'IP Address' (dropdown). Below this is a table with columns: No., Edit, Preview, Status, IP Address, and Manuf. The table contains three rows of device information. Below the table are buttons for 'Device Search', 'Initialize', 'Modify IP', 'Add', and 'Manual Add'. There is a section for 'Added Device' with a 'Link Info' button. Below this is another table with columns: No., IP Address, and Channel. At the bottom, there are buttons for 'Delete', 'H.265 Auto Switch' (checkbox), 'Import', and 'Export'. A status bar shows 'Residue bandwidth/T...' as '320.00Mbps/320.00Mbps'. At the very bottom are 'Back' and 'Next' buttons.

No.	Edit	Preview	Status	IP Address	Manuf
73					
1		LIVE	*	192.168.1.1	Onvif
2		LIVE	*	192.168.1.1	Private
3		LIVE	*	192.168.1.1	Private

No.	IP Address	Channel
1	192.168.1.1	D1, D3

4.1.4.5 RAID Manager

Background Information

RAID (redundant array of independent disks) is a data storage virtualization technology that combines multiple physical HDD components into a single logical unit for the purposes of data redundancy, performance improvement, or both.



RAID function is for some series product only. Slight difference may be found on the user interface.

Procedure

- Step 1 Select **Main Menu > STORAGE > RAID > RAID**.
The **RAID** interface is displayed. See Figure 4-31.

Figure 4-31

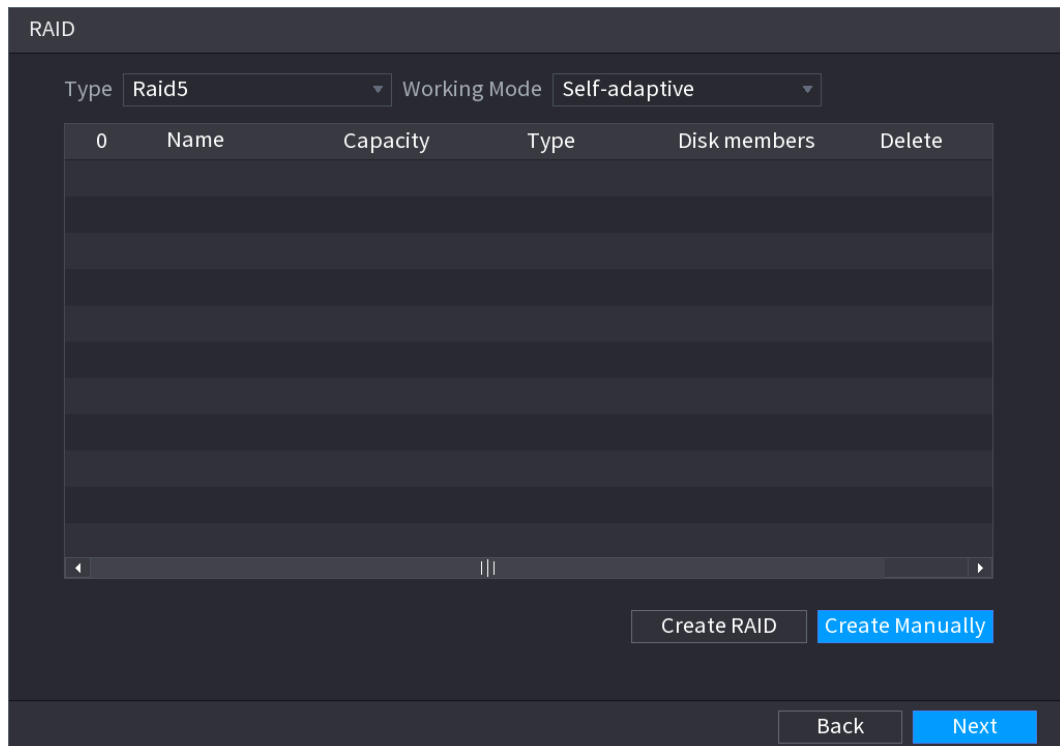

Step 2 You can click **Create RAID** or **Create Manually**, and all the disks involved will be formatted.

- Click **Create RAID**, the system will create RAID automatically.
 - ◇ If there is no existing RAID and no hot spare disk, the system will create RAID5 and a hot spare disk automatically.
 - ◇ If there is no existing RAID, but existing hot spare disk, the system will only create RAID5 and use the existing hot spare disk automatically.

If there is existing RAID and existing hot spare disk, the system will delete the original RAID and create RAID5 with all the disks and use the existing hot spare disk automatically.

- Click **Create Manually**.
 1. Select RAID type and disks as system instructed.
 2. Click **Create Manually**, and then the format disk notice is displayed.
 3. Click **OK**.

Step 3 After creating RAID, the disks need to sync with each other to finish the process. For RAID5 and RAID6, you can select different working modes.

- Self-Adaptive: Automatically adjust the RAID sync speed according to the business status.
- Sync First: Resource priority is assigned to RAID sync.
- Business First: Resource priority is assigned to business operations.
- Balance: Resource is evenly distributed to RAID sync and business operations.

4.1.4.6 Schedule

After setting record schedule and snapshot schedule, the device can automatically record video and snapshot image at the specified time.

Select **Main Menu > STORAGE > Schedule**, you can go to the **Schedule** interface.

4.1.4.6.1 Recording Schedule

Background Information

After set schedule record, device can record video file according to the period you set here. For example, the alarm record period is from 6:00–18:00 Monday, device can record alarm video files during the 6:00–18:00.

All channels are record continuously by default. You can set customized record period and record type.

Procedure

Step 1 Click **Next**.

The **Rec** interface is displayed. See Figure 4-32.

Figure 4-32 Rec

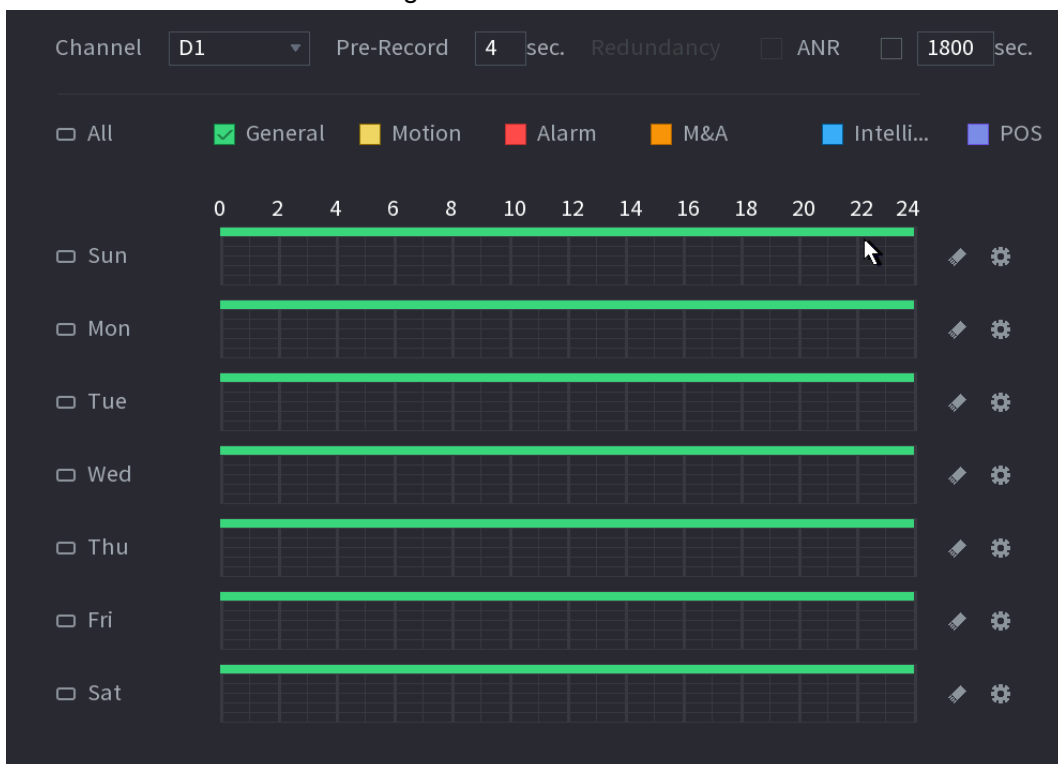

Step 2 Select a channel from the drop-down list, you can set different record plans for different channels. Select **All** if you want to set for all channels. See Table 4-9.

Table 4-9 Channel parameters

Parameter	Description
Channel	In the Channel list, select a channel to record the video.
Pre-record	In the Pre-record list, enter the amount of time that you want to start the recording in advance.



Parameter	Description
Redundancy	<p>If there are several HDDs installed to the Device, you can set one of the HDDs as the redundant HDD to save the recorded files into different HDDs. In case one of the HDDs is damaged, you can find the backup in the other HDD.</p> <ul style="list-style-type: none"> ● Select Main Menu > STORAGE > Disk Manager, and then set a HDD as redundant HDD. ● Select Main Menu > STORAGE > Schedule > Record, and then select the Redundancy check box. <ul style="list-style-type: none"> ◇ If the selected channel is not recording, the redundancy function takes effect next time you record no matter you select the check box or not. ◇ If the selected channel is recording, the current recorded files will be packed, and then start recording according to the new schedule. <p></p> <ul style="list-style-type: none"> ● This function is for some series products only. ● The redundant HDD only back up the recorded videos but not snapshots.
ANR	<p>You can set ANR (auto network resume) function.</p> <ul style="list-style-type: none"> ● The IPC continues record once the NVR and IPC connection fails. After the network becomes normal, the NVR can download record file during the offline period from the IPC. It is to guarantee there is no record loss on current connected IPC channel. ● Set the max. record upload period. Once the offline period is longer than the period you set here, IPC can only upload the record file during the specified period. <p></p> <p>This function is for IPC that installed SD card and the record function is enabled.</p>
Period	<p>Define a period during which the configured recording setting is active. See Figure 4-33.</p> <p></p> <p>The system only activates the alarm in the defined period.</p>
Copy to	<p>Click Copy to to copy the settings to other channels.</p>

Figure 4-33 Period

Period

Day Sun

Period	Time Range	General	Motion	Alarm	M&A	Inte...	POS
Period 1	00 : 00 - 24 : 00	<input checked="" type="checkbox"/>	<input type="checkbox"/>	<input type="checkbox"/>	<input type="checkbox"/>	<input type="checkbox"/>	<input type="checkbox"/>
Period 2	00 : 00 - 24 : 00	<input type="checkbox"/>	<input type="checkbox"/>	<input type="checkbox"/>	<input type="checkbox"/>	<input type="checkbox"/>	<input type="checkbox"/>
Period 3	00 : 00 - 24 : 00	<input type="checkbox"/>	<input type="checkbox"/>	<input type="checkbox"/>	<input type="checkbox"/>	<input type="checkbox"/>	<input type="checkbox"/>
Period 4	00 : 00 - 24 : 00	<input type="checkbox"/>	<input type="checkbox"/>	<input type="checkbox"/>	<input type="checkbox"/>	<input type="checkbox"/>	<input type="checkbox"/>
Period 5	00 : 00 - 24 : 00	<input type="checkbox"/>	<input type="checkbox"/>	<input type="checkbox"/>	<input type="checkbox"/>	<input type="checkbox"/>	<input type="checkbox"/>
Period 6	00 : 00 - 24 : 00	<input type="checkbox"/>	<input type="checkbox"/>	<input type="checkbox"/>	<input type="checkbox"/>	<input type="checkbox"/>	<input type="checkbox"/>

Copy to

All

Sun Mon Tue Wed Thu Fri Sat

OK Cancel

Step 3 Set record type. See Figure 4-34.

Figure 4-34 Record type

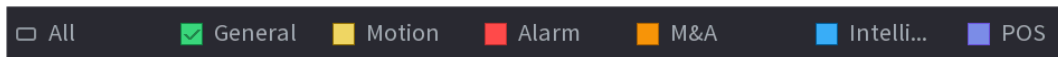

- When the record type is Motion (motion detection), alarm, M&A, IVS and POS, enable the channel record function when corresponding alarm occurs. For example, when the alarm type is MD, select **Main Menu > ALARM > Video Detection > Motion Detection**, select the record channel and enable record function.
- When the record type is Motion (motion detection), alarm, M&A, IVS and POS, refer to "4.8.5 Video Detection", "4.8.3 Alarm Input", "4.7.1.3 IVS" and "4.9 POS" for detailed information.

Figure 4-35 Select record channel

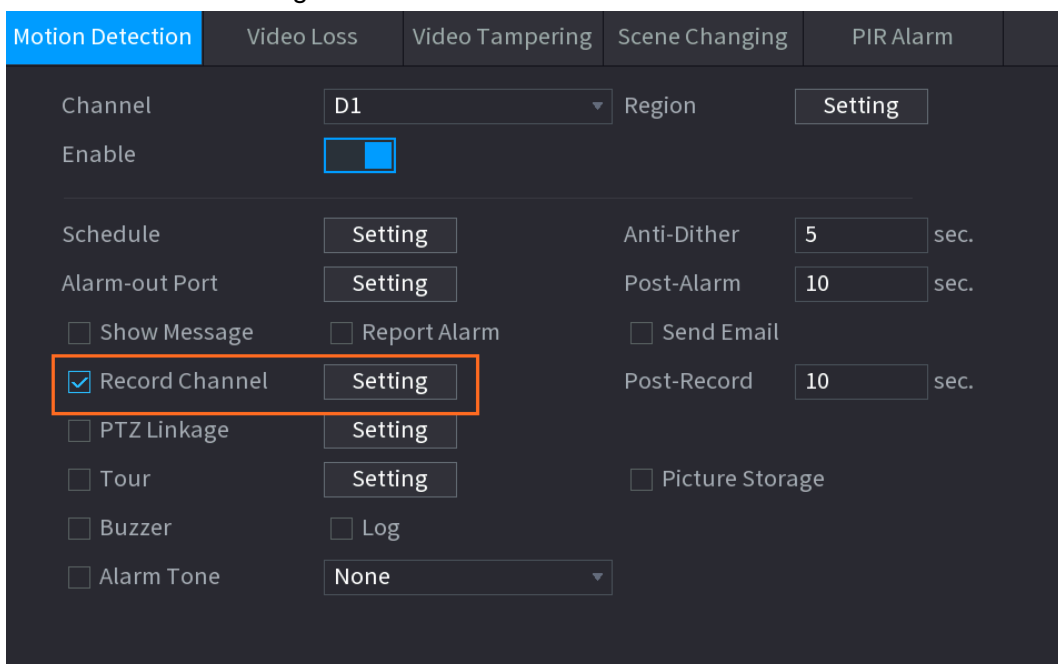

Step 4 Set record period. It includes edit mode and draw mode. See Figure 4-38.



If you have added a holiday, you can set the record period for the holiday.

Figure 4-36 Set record period

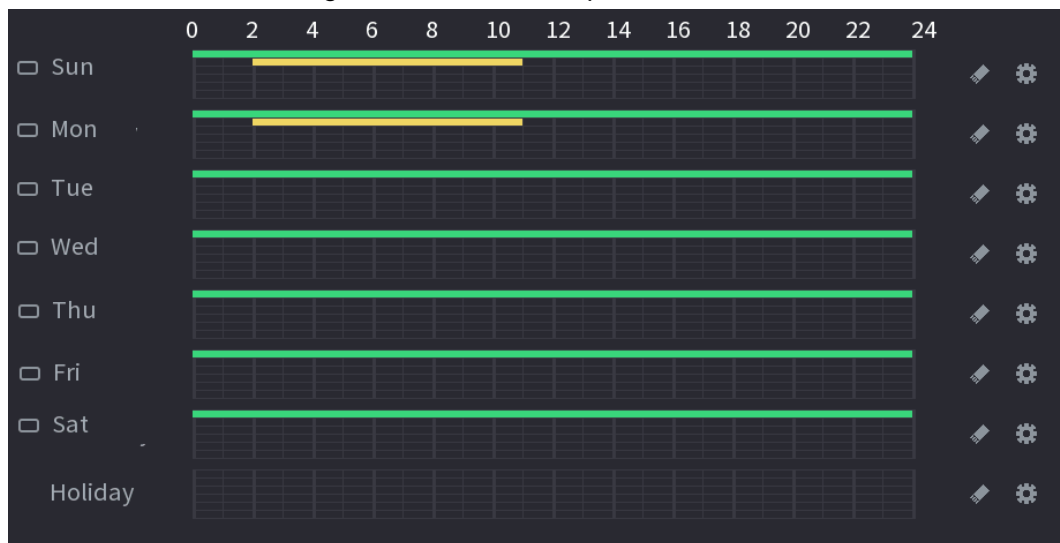

- Define the period by drawing.
 1. Select a corresponding date to set.
 - ◇ Define for the whole week: Click next to **All**, all the icon switches to , you can define the period for all the days simultaneously.
 - ◇ Define for several days of a week: Click before each day one by one, the icon switches to . You can define the period for the selected days simultaneously.
 2. On the timeline, left click mouse and then drag to define a period.

There are six periods in one day, the Device starts recoding the selected event type in the defined period. In Figure 4-38, the different color bars stand for different record types.

 - ◇ Green stands for general record.
 - ◇ Yellow stands for MD (motion detection) record.
 - ◇ Red stands for alarm record.
 - ◇ Blue stands form intelligent record.
 - ◇ Orange stands for MD&Alarm record.
 - ◇ Purple stands for POS record.
 - ◇ Once the time period overlaps, the record priority: **M&A > Alarm > POS > Intelligent > Motion > General**.
 - ◇ Select a record type and then click the of the corresponding date to clear the corresponding period.

Figure 4-37 Set period by drawing



The MD record and alarm record function are both null if you enabled MD&Alarm function.

- Define the period by editing.
 1. Select a date and then click . The **Period** interface is displayed.

Figure 4-38 Set period by editing

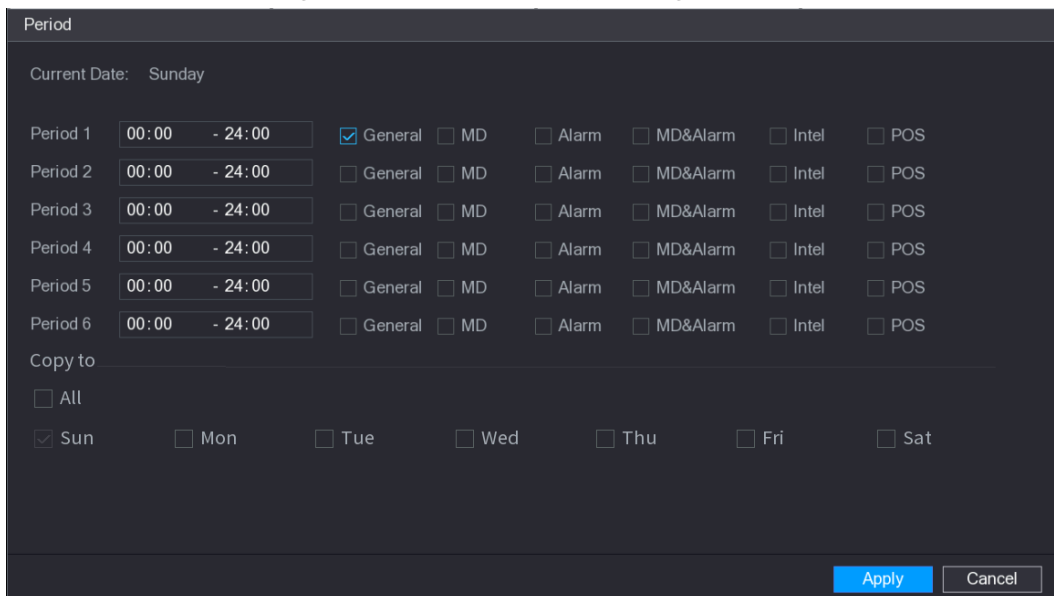

2. Set record type for each period.
 - ◇ There are six periods for you to set for each day.
 - ◇ Under **Copy to**, select **All** to apply the settings to all the days of a week, or select specific day(s) that you want to apply the settings to.
3. Click **Apply** to save the settings.

Step 5 Click **Apply** to complete the settings.

Enable auto record function so that the record plan can become activated. Refer to "4.1.4.6.3 Record Control" for detailed information.

4.1.4.6.2 Snapshot Schedule

Background Information

You can set schedule snapshot period.

After set schedule snapshot, device can snapshot image according to the period you set here. For example, the alarm snapshot period is from 6:00–18:00 Monday, device can snapshot during the 6:00–18:00 when an alarm occurs.

Procedure

Step 1 Click **Snapshot**, the device goes to following interface. See Figure 4-39.



Select **Main Menu > STORAGE > Schedule > Snapshot**, you can go to the snapshot interface.

Figure 4-39 Snapshot

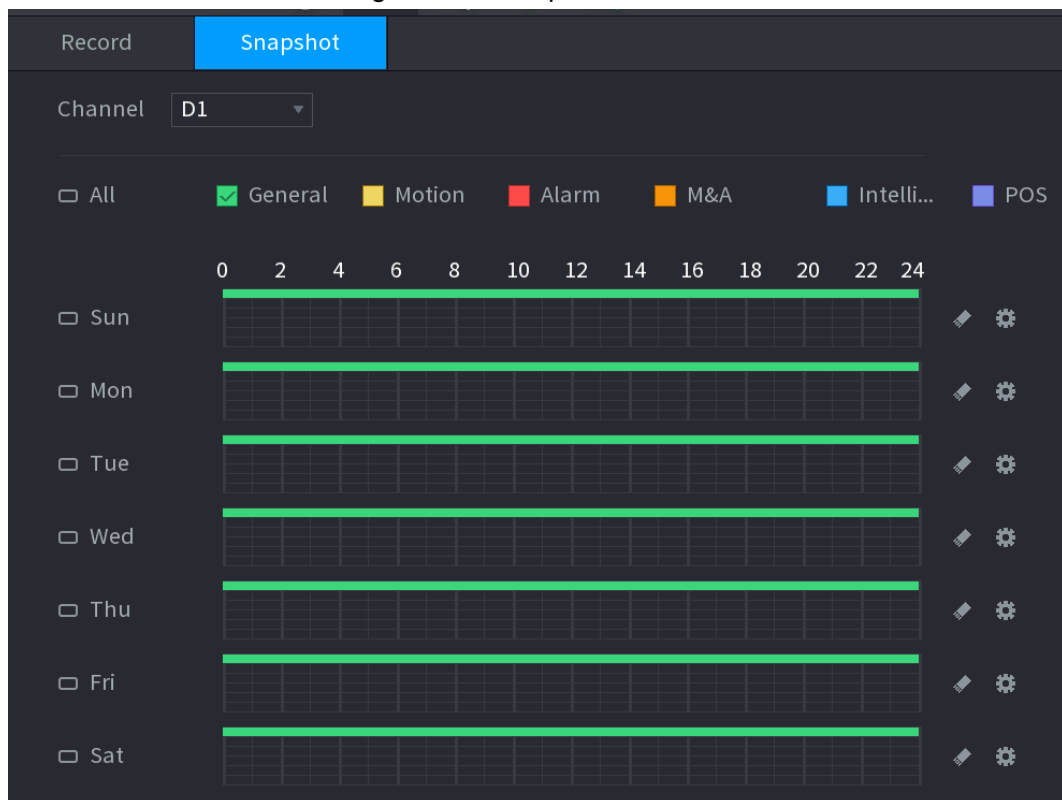

Step 2 Select a channel to set schedule snapshot.

Step 3 Set snapshot type as schedule. Refer to "4.2.6.2 Snapshot" for detailed information.

Step 4 Check the box to set alarm type. See Figure 4-40.

Figure 4-40 Alarm type

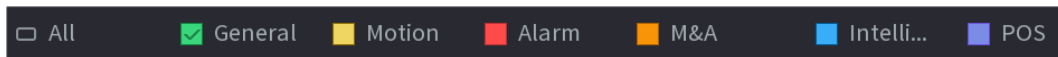

- When the record type is Motion (motion detection), alarm, M&A, IVS and POS, enable the channel record function when corresponding alarm occurs. For example, when the alarm type is MD, select **Main Menu > ALARM > Video Detection > Motion Detection**, select the record channel and enable record function. See Figure 4-41.
- When the record type is Motion (motion detection), alarm, M&A, IVS and POS, refer to "4.8.5 Video Detection", "4.8.3 Alarm Input", "4.7.1.3 IVS" and "4.9 POS" for detailed information.

Figure 4-41 Motion detection

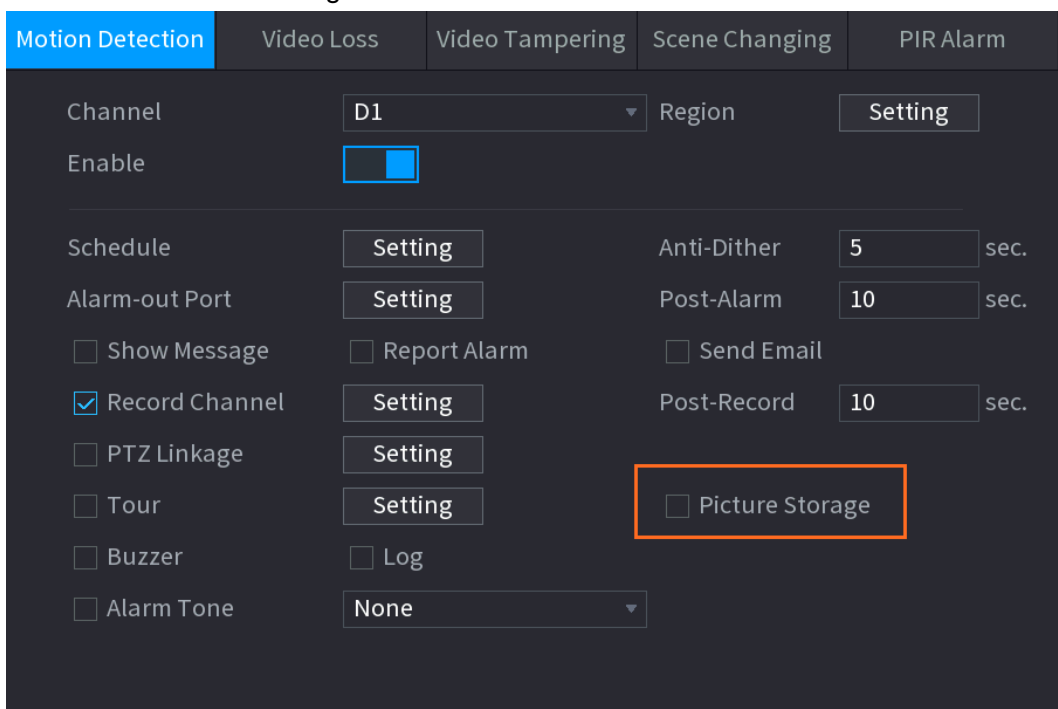

Step 5 Refer to "4.1.4.6.1 Recording Schedule" to set snapshot period.

Step 6 Click **Apply** button to save snapshot plan.



Enable auto snapshot function so that the snapshot plan can become activated. Refer to "4.1.4.6.3 Record Control" for detailed information.

4.1.4.6.3 Record Control

Background Information

After set schedule record or schedule snapshot, you need to enable auto record and snapshot function so that system can automatically record or snapshot.

- Auto: System automatically records at the type and record period you set in Schedule interface.
- Manual: System records general files for all day.



You need to have storage authorities to implement the Manual record operation. Make sure the HDD has been properly installed.

Procedure

Step 1 Right click mouse and then select **Manual Control > Record Mode** or select **Main Menu > STORAGE > Record**. See Figure 4-42.

Figure 4-42 Record mode

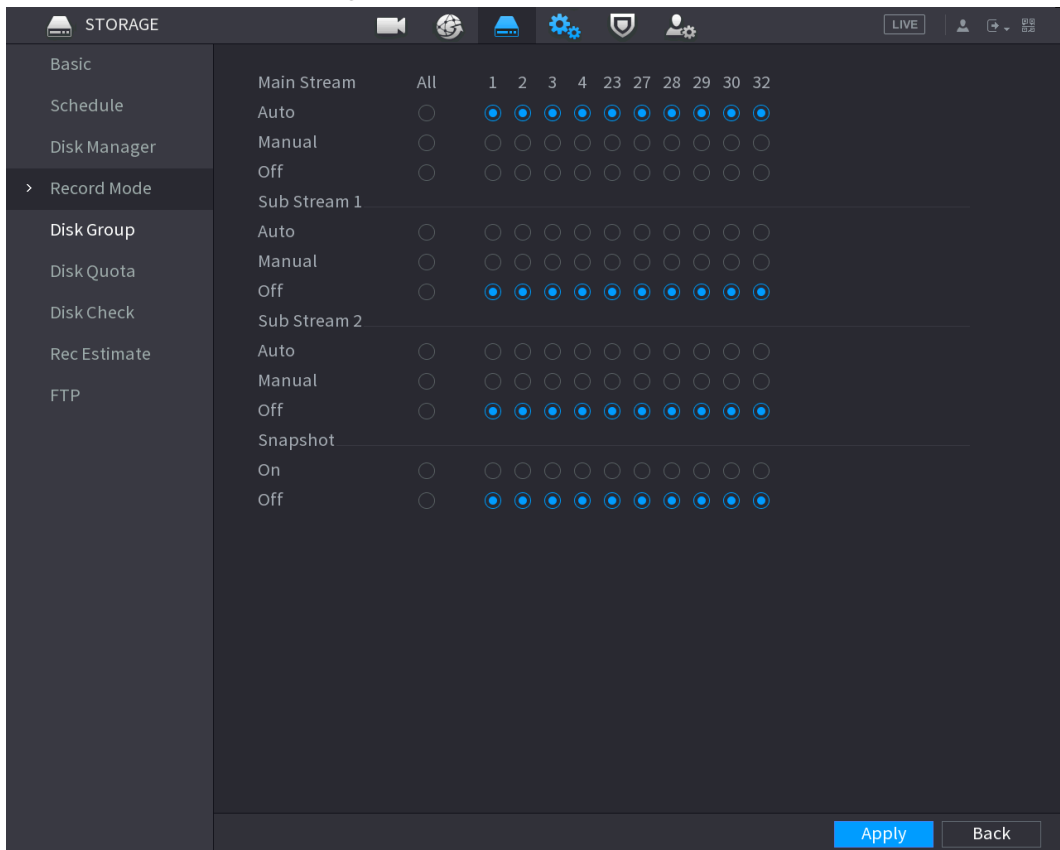

Step 2 Configure parameters.

Table 4-10 Record mode parameters

Parameter	Description
Channel	Displays all the analog channels and the connected digital channels. You can select a single channel or select All.
Record status	<ul style="list-style-type: none"> Auto: Automatically record according to the record type and recording time as configured in the recording schedule. Manual: Keep general recording for 24 hours for the selected channel. Off: Do not record.
Snapshot status	Enable or disable the scheduled snapshot for the corresponding channels.

Step 3 Click **Apply** to complete settings.

4.2 Camera

4.2.1 Connection

Select **Main Menu > Camera > Camera List > Camera List**, you can add remote devices. See Figure 4-43.

After adding remote devices to the NVR, you can view the video on the NVR, and manage and storage the video file. Different series products support different remote device amount.

Figure 4-43 Add remote device

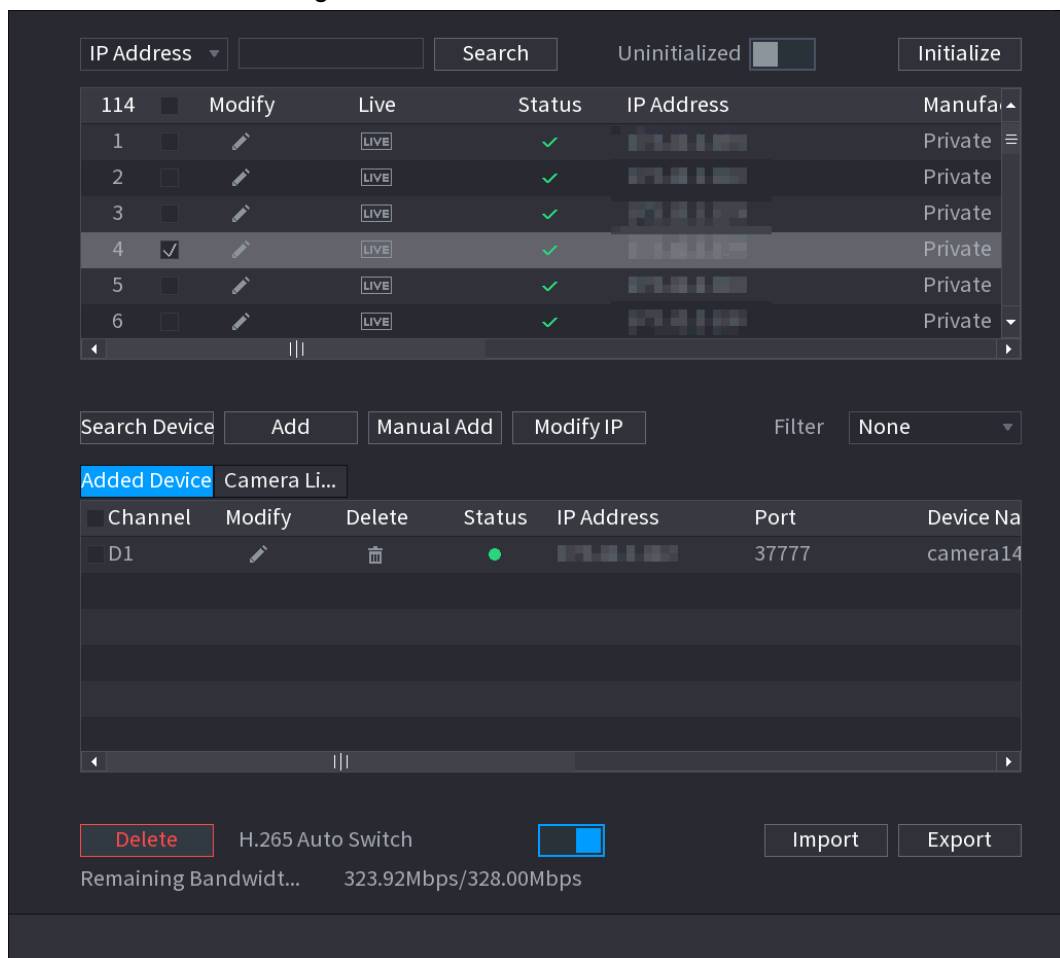

4.2.1.1 Changing IP address

Procedure

- Step 1** Select **Main Menu > Camera > Camera List > Camera List**, check the box before the camera name and then click **Modify IP** or click the before the camera name. The **Modify IP** interface is displayed. See Figure 4-44.



Check the box before several cameras, change the IP addresses of several cameras at the same time.

Figure 4-44 Modify IP

Modify IP

Selected Device Quantity: 1

DHCP
 Static

Username
 Password

IP Address
 Subnet Mask
 Default Gateway
 Incremental Value

1	SN	IP Address
1		

Step 2 Select IP mode.

- Check **DHCP**, there is no need to input IP address, subnet mask, and default gateway. Device automatically allocates the IP address to the camera.
- Check **Static**, and then input IP address, subnet mask, default gateway and incremental value.



- If it is to change several devices IP addresses at the same time, input incremental value. Device can add the fourth address of the IP address one by one to automatically allocate the IP addresses.
- If there is IP conflict when changing static IP address, device pops up IP conflict dialogue box. If batch change IP address, device automatically skips the conflicted IP and begin the allocation according to the incremental value.

Step 3 Input remote device user name and password.



When change IP addresses of several devices at the same time, make sure the cameras user name and passwords are the same.

Step 4 Click **OK** button to save settings.

After the modification and then search again, device displays new IP address.

4.2.1.2 Auto Changing H.265

Background Information

For the remote device that first registered to the system, it can automatically adopts encode format as H.265 if you enable H.265 Auto switch function. The resolution will not be adjusted, and the stream value will be halved.

Click **H.265 Auto Switch** at the bottom of the interface, it is from to . The function is enabled. See Figure 4-43.

Figure 4-45 H.265 auto switch

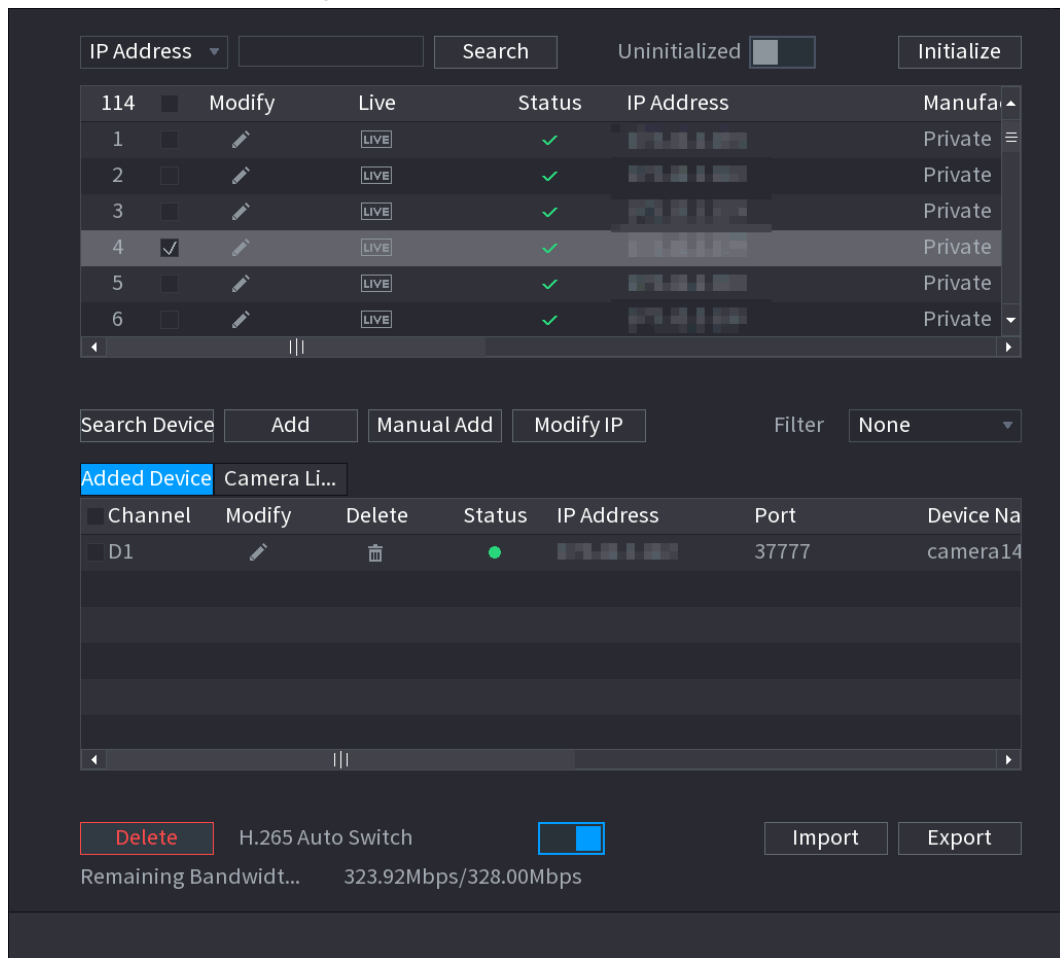

4.2.1.3 IP Export

Background Information

Device can export the added device list to your local USB device.

Procedure

- Step 1 Insert the USB device and then click the **Export**.
The **Browse** interface is displayed. See Figure 4-46.

Figure 4-46 Browse

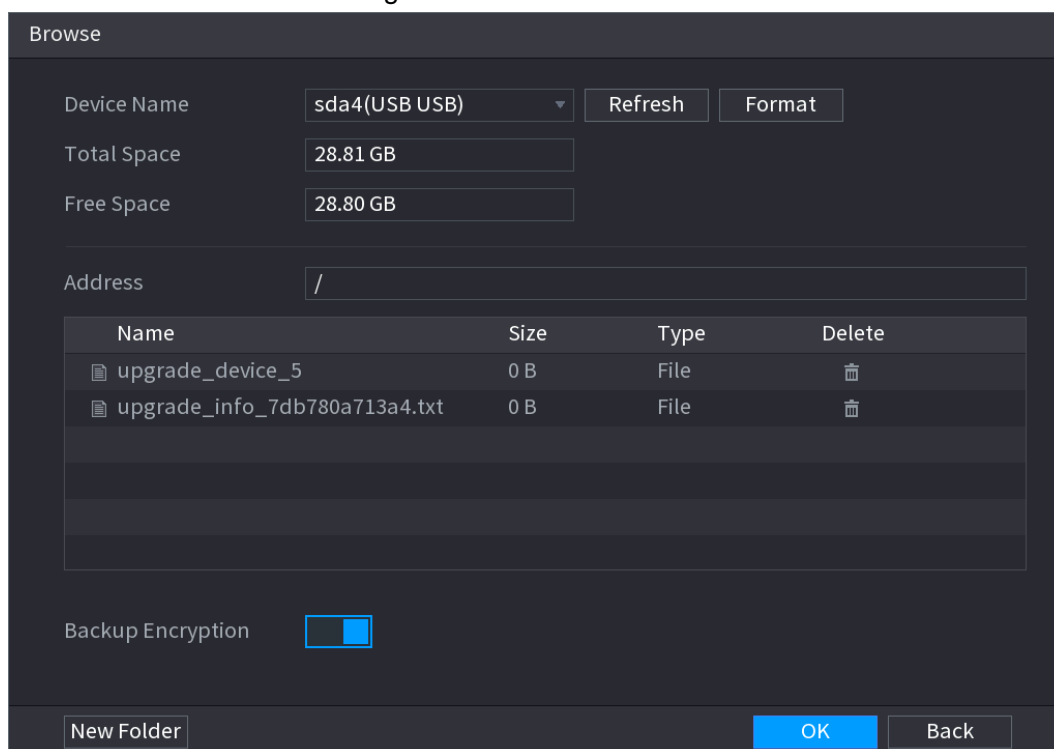

Step 2 Select **Address** to save export file.

Step 3 Click **OK**.

Step 4 Device pops up a dialogue box to remind you successfully exported.



When exporting IP address, the **Backup Encryption** check box is checked by default. The file information includes IP address, port, channel number, manufacturer, user name, and password.

- If you select the File Backup Encryption check box, the file format is .backup.
- If you clear the File Backup Encryption check box, the file format is .csv. In this case, there might be a risk of data leakage.

4.2.1.4 IP Import

Procedure

Step 1 Click **Import**.

The **Browse** interface is displayed. See Figure 4-47.

Figure 4-47

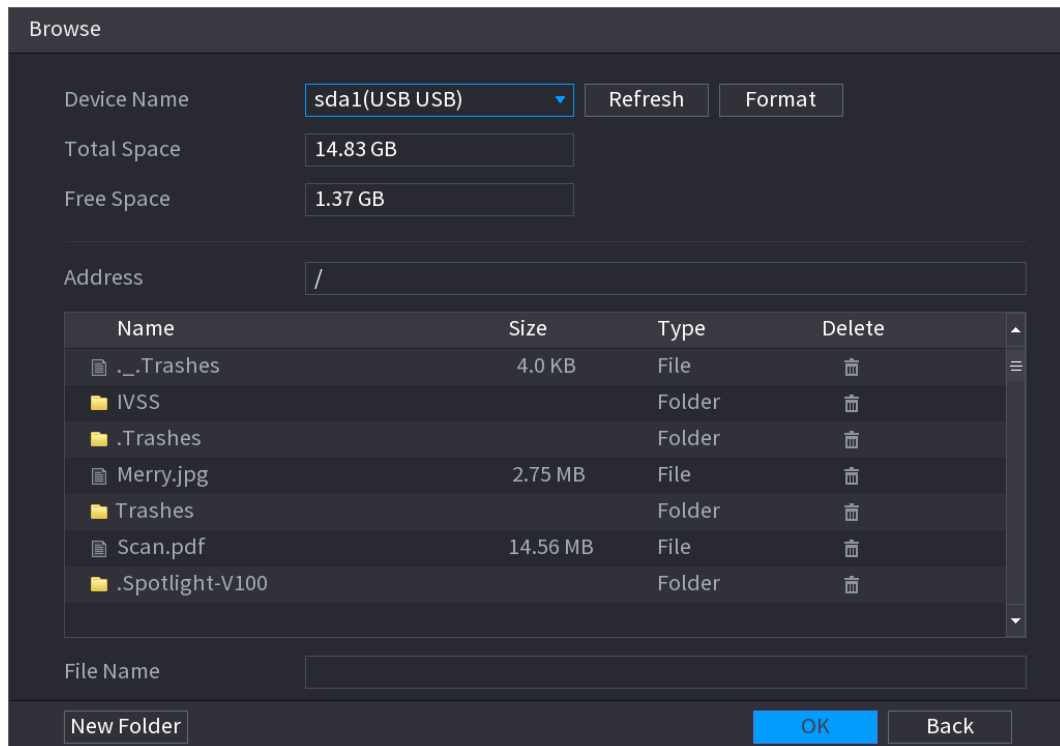

- Step 2** Go to **Address** to select the import file and then click **OK**.
System pops up a dialogue box to remind you successfully imported.



If the imported IP has conflicted with current added device, system pops up a dialogue box to remind you. You have two options.

- Step 3** Click **OK**.
The imported information is on the Added Device list.

4.2.2 Remote Device Initialization

Background Information

Remote device initialization can change remote device login password and IP address.



- When connect a camera to the NVR via PoE port, NVR automatically initialize the camera. The camera adopts NVR current password and email information by default.
- When connect a camera to the NVR via PoE port after NVR upgraded to the new version, the NVR may fail to initialize the camera. Go to the Registration interface to initialize the camera.

Procedure

- Step 1** Select **Main Menu > Camera > Camera List > Add Camera**.
- Step 2** Enable **Uninitialized**, and then click **Search Device**.
Device displays camera(s) to be initialized.
- Step 3** Select a camera to be initialized and then click **Initialize**.
The **Enter Password** interface is displayed. See Figure 4-48

Figure 4-48

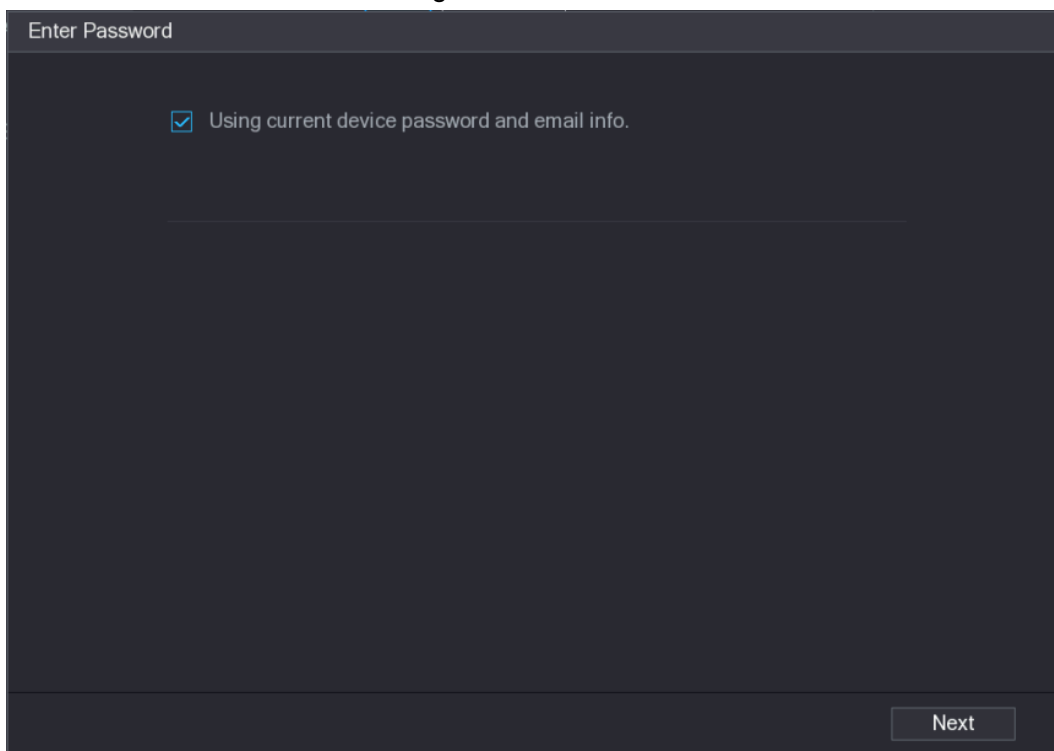

Table 4-11

Parameter	Description
User	The default is admin.
Password	The new password can be set from 8 characters through 32 characters and contains at least two types from number, letter and special characters (excluding "", "", ",", ":" and "&"). Enter a strong password according to the password strength bar indication.
Confirm Password	

Step 4 Set remote device password and email information.



If you want to use current device password and email information, the remote device automatically uses NVR admin account information (login password and email).

There is no need to set password and email. Go to step 6.

1) Cancel **Using current device password and email info.**

The **Enter Password** interface is displayed. See Figure 4-49.

Figure 4-49

2) Configure parameters.

Table 4-12

Parameter	Description
User	The default is admin .
Password	The new password can be set from 8 characters through 32 characters and contains at least two types from number, letter and special characters (excluding "", "", ";", ":" and "&"). Enter a strong password according to the password strength bar indication.
Confirm Password	



For your device own safety, create a strong password of your own choosing. We also recommend you change your password periodically especially in the high security system.

- Step 5** Click **Next**.
The **Password Protection** interface is displayed. See Figure 4-50.

Figure 4-50

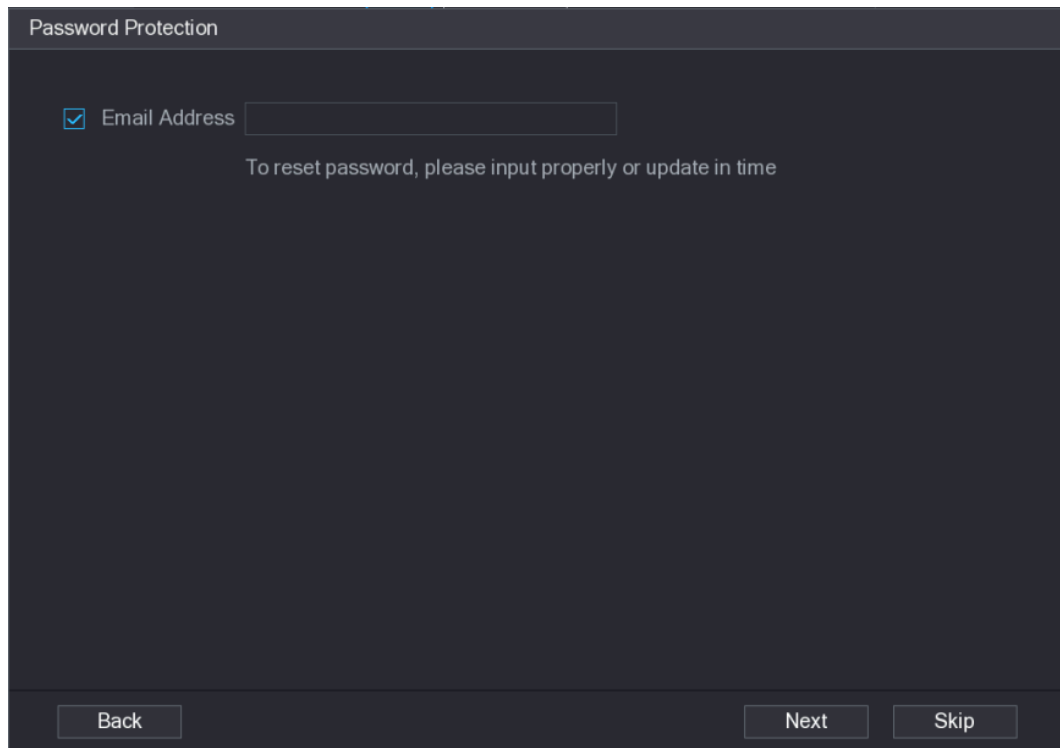

Password Protection

Email Address

To reset password, please input properly or update in time

Back Next Skip

- Step 6** Set email information.
Input an email address for reset password purpose.



Cancel the box and then click Next or Skip if you do not want to input email information here.

- Step 7** Click **Next**.
The **Network** interface is displayed. See Figure 4-51.

Figure 4-51

1	Serial No.	IP Address
1		192.168.1.254

Step 8 Set camera IP address.

- Check **DHCP**, there is no need to input IP address, subnet mask, and default gateway. Device automatically allocates the IP address to the camera.
- Check **Static**, and then input IP address, subnet mask, default gateway and incremental value.



- If it is to change several devices IP addresses at the same time, input incremental value. Device can add the fourth address of the IP address one by one to automatically allocate the IP addresses.
- If there is IP conflict when changing static IP address, device pops up IP conflict dialogue box. If batch change IP address, device automatically skips the conflicted IP and begin the allocation according to the incremental value.

Step 9 Click **Next**.

The **Device Initialization** interface is displayed. See Figure 4-52.

Figure 4-52

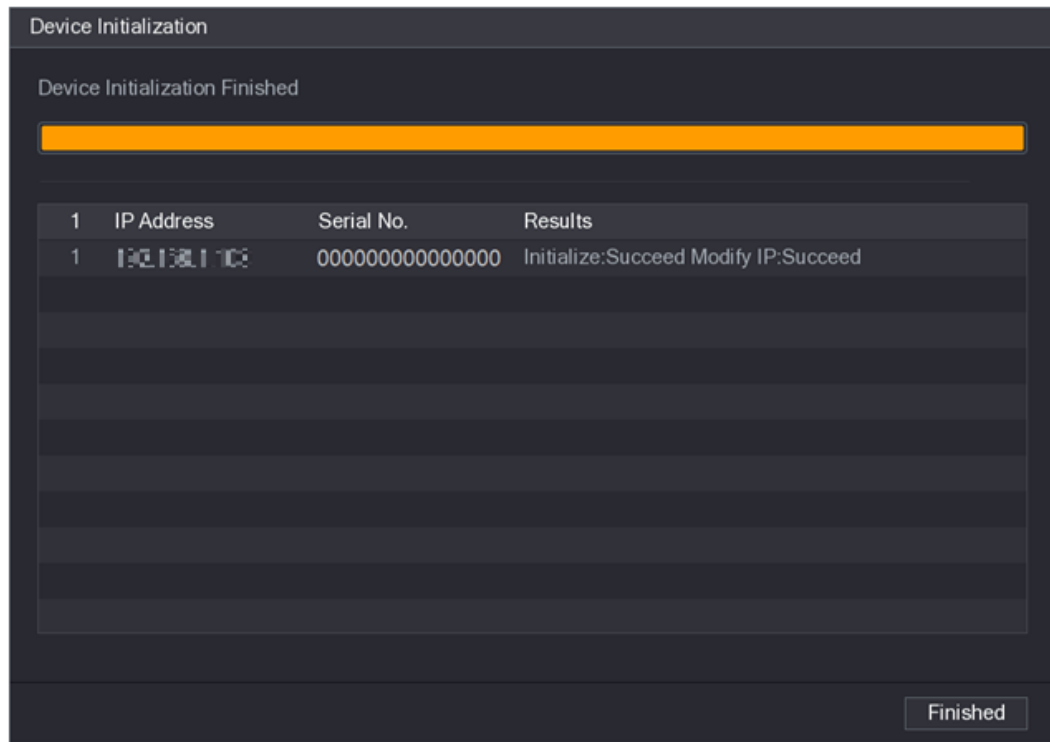

Step 10 Click **Finished** to complete the setup.

4.2.3 Shortcut Menu to Add Camera

Background Information

If you have not registered a remote device to a channel, go to the live view interface to add.

Procedure

- Step 1 On the live view interface, move your mouse to window. There is an icon + on the channel window. See Figure 4-53.

Figure 4-53

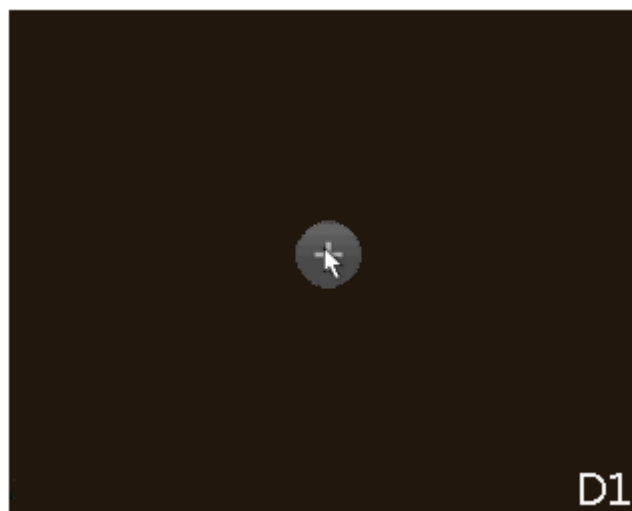

- Step 2 Click "+", device pops up interface to add network camera. Refer to "4.1.4.4 Adding Camera" for detailed information.

4.2.4 Image

Background Information

You can set network camera parameters according to different environments. It is to get the best video effect.

Procedure

- Step 1** Select **Main Menu > Camera > Image**.
The **Image** interface is displayed. See Figure 4-54.

Figure 4-54 Image

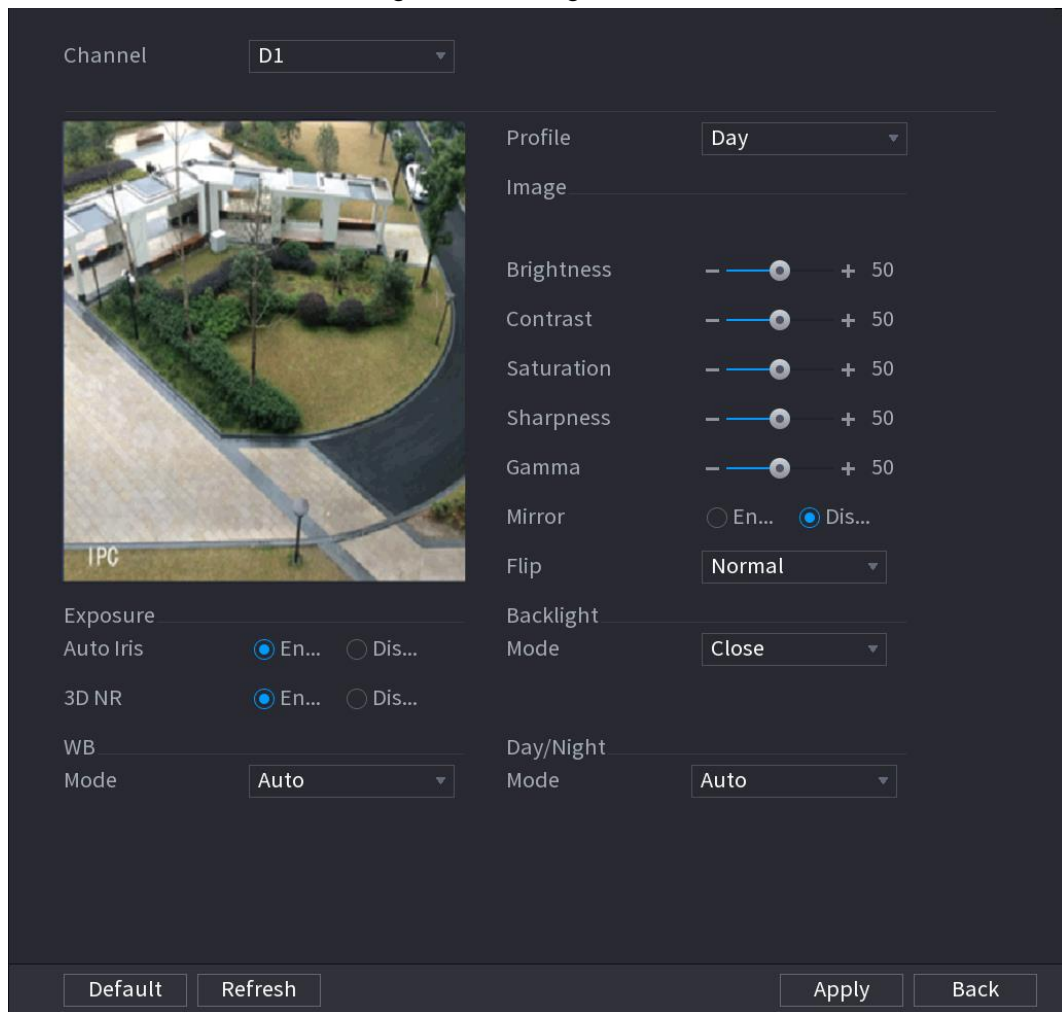

- Step 2** Configure parameters. See Table 4-13.





Different series network camera displays different parameters. The actual product shall prevail.

Table 4-13 Image parameters

Parameter	Description
Channel	In the Channel list, select the channel that you want to configure.
Profile	There are three config files for you. System has configured the corresponding parameters for each file, you can select according to your actual situation.

Parameter	Description	
Brightness	Adjusts the image brightness. The bigger the value is, the brighter the image will become. Adjusts the brightness according to actual environment.	
Contrast	Adjusts the image contrast. The bigger the value is, the more obvious the contrast between the light area and dark area will become. Adjusts the contrast according to actual environment.	
Saturation	Adjusts the color shades. The bigger the value, the lighter the color will become. Adjusts the saturation according to actual environment.	
Sharpness	Adjusts the sharpness of image edge. The bigger the value is, the more obvious the image edge is. Adjusts the sharpness according to actual environment.	
Gamma	It is to adjust image brightness and enhance the image dynamic display range. The bigger the value is, the more bright the video is.	
Mirror	Enable the function, the left and right side of the video image will be switched. It is disabled by default.  This function is for some series products only.	
Flip	It is to set monitor video display direction. It includes Normal, 180°, 90°, 270°.	
Exposure	Auto Iris	<ul style="list-style-type: none"> It is for the camera of auto iris only. After enable auto iris function, the iris can automatically zoom in/zoom out according to the brightness of the environment and the image brightness changes too. If disable the auto iris function, the iris does not automatically zoom in/zoom out according to the brightness of the environment when the iris is at the biggest value.
	3D NR	This function specially applies to the image which frame rate is configured as 2 at least. It reduces the noises by making use of the information between two frames. The bigger the value is, the better the effect.

Parameter	Description
Backlight Mode	<p>You can set camera Backlight mode.</p> <ul style="list-style-type: none"> ● SSA: In the backlight environment, the system can automatically adjust image brightness to clearly display the object. ● BLC: <ul style="list-style-type: none"> ◇ Default: The device auto exposures according to the environments situation so that the darkest area of the video is cleared. ◇ Customize: After select the specified zone, the system can expose the specific zone so that the zone can reach the proper brightness. ● WDR: In backlight environment, it can lower the high bright section and enhance the brightness of the low bright section. So that you can view these two sections clearly at the same time. ● HLC: In the backlight environment, it can lower the brightness of the brightest section and reduce the area of the halo and lower the brightness of the whole video. ● Stop: It is to disable the BLC function.
WB Mode	<p>You can set camera WB mode. It can affect the image whole hue so that the image can accurately display the environment status.</p>  <p>Different cameras supports different WB modes such as auto, manual ,natural light, outdoor and etc.</p>
Day/Night Mode	<p>Configure the color and black&white mode of the image. This setting is not affected by the configuration files. The default setting is Auto.</p> <ul style="list-style-type: none"> ● Color: The camera outputs color image only. ● Auto: Depends on the camera, such as overall brightness and whether there is an IR light, either color image or black&white image is output. ● B/W: The camera outputs Black and white image only. ● Sensor: It is to set when there is peripheral connected IR light.  <p>The Sensor item is for some non-IR device only.</p>

Step 3 Click **Apply**.

4.2.5 Video Overlay

You can set values for overlay and private masking.

4.2.5.1 Overlay

Background Information

You can add the information of time and channel in the live view interface.

Procedure

Step 1 Select **Main Menu > CAMERA > Overlay > Overlay**.



Step 2 Configure parameters.

Table 4-14 Video overlay parameters

Parameter	Description
Channel	Select a channel.
Time Title	Select Time Title , and the time tile will be displayed in live view and playback. Drag time title to the target place and click Apply .
Channel Title	Select Channel Title , and the channel tile will be displayed in live view and playback. Drag channel title to the target place and click Apply .
Custom Title	You can custom title to be overlaid on the screen. Click Setting to set the information such as font size, title content and text alignment, and then click OK .
Default	Set as device default configuration.
Copy to	Click Copy to to copy the settings to other channels.

Step 3 Click **Apply**.

4.2.5.2 Privacy Masking

You can set the privacy masking area on the screen to guarantee the privacy of the area.

Procedure

Step 1 Select **Main Menu > CAMERA > Overlay > Privacy Masking**.

Figure 4-55 Privacy masking

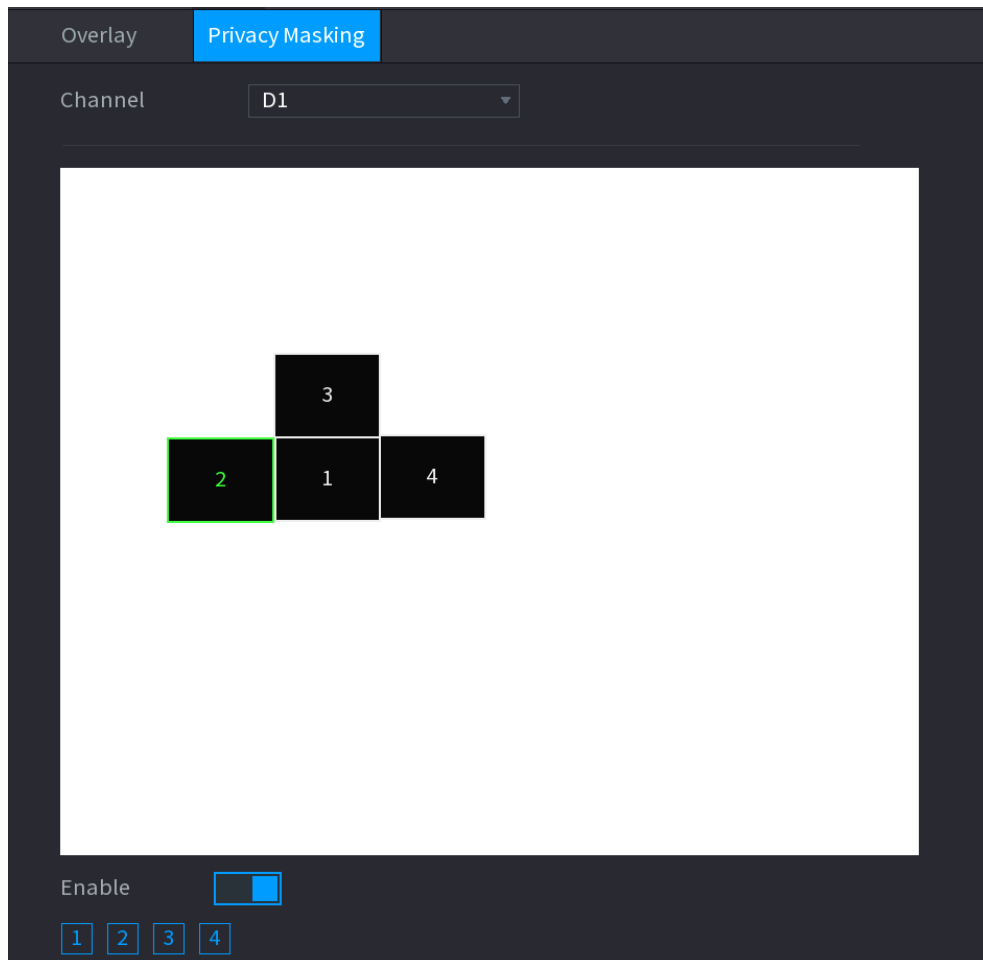

Step 2 Configure parameters.

Table 4-15 Privacy masking parameters

Parameter	Description
Channel	Select a channel.
1, 2, 3, 4	Select Enable to enable privacy masking. The number represents the number of masking areas. You can select a number and drag masking areas to the screen, and you can also change the size of areas or drag an area to other place.  You can drag up to 4 masking areas to one channel.
Default	Set as device default configuration.

Step 3 Click **Apply**.

4.2.6 Encode

You can set video bit stream and image parameters.

4.2.6.1 Encode

Background Information

You can set video bit stream parameters such as bit stream type, compression, resolution.



Some series products support three streams: main stream, sub stream 1, sub stream 2. The sub stream maximally supports 1080p.

Procedure

- Step 1** Select **Main Menu > Camera > Encode**.
The **Encode** interface is displayed. See Figure 4-56.

Figure 4-56 Audio/Video

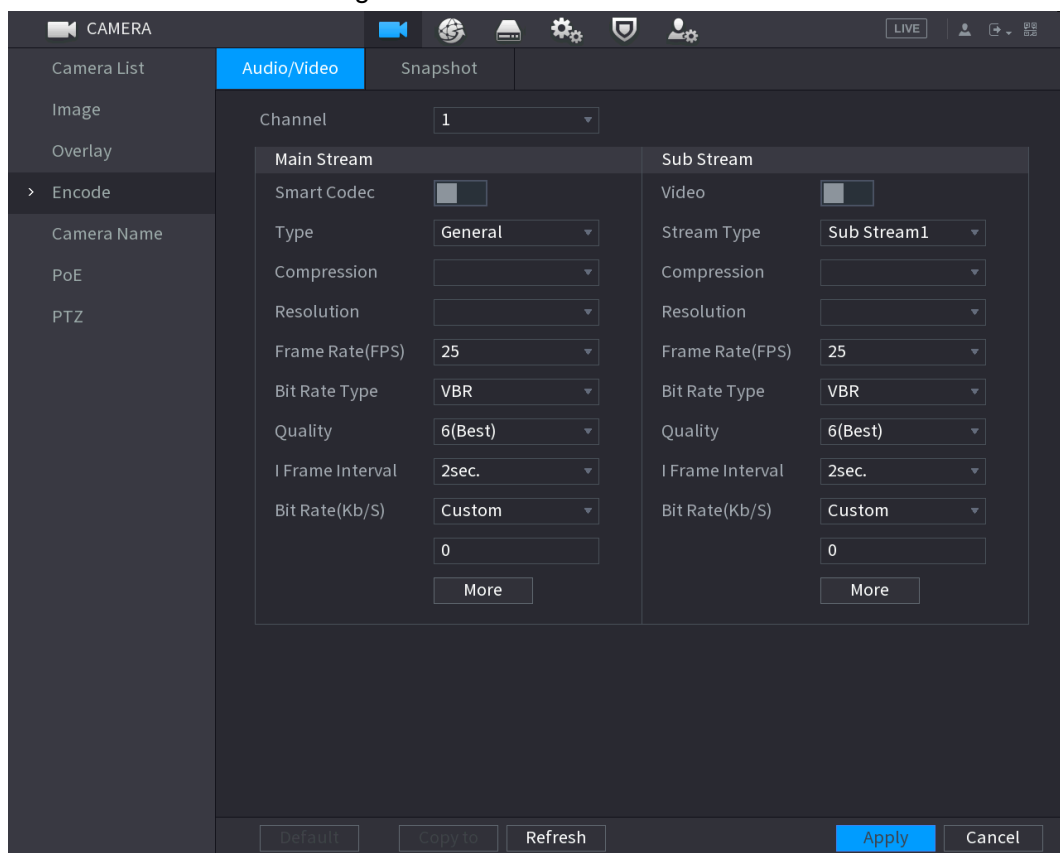

- Step 2** Configure parameters. See Table 4-16.

Table 4-16 Audio/video parameters

Parameter	Description
Channel	In the Channel list, select the channel that you want to configure the settings for.
Smart Codec	Enable the smart codec function. This function can reduce the video bit stream for non-important recorded video to maximize the storage space. <ul style="list-style-type: none"> • : Enabled. • : Disabled.

Parameter	Description
Type	<ul style="list-style-type: none"> • Main Stream: In the Type list, select General, MD (Motion Detect), or Alarm. • Sub Stream: This setting is not configurable.
Compression	In the Compression list, select the encode mode. <ul style="list-style-type: none"> • H.265: Main profile encoding. This setting is recommended. • H.264H: High profile encoding. Low bit stream with high definition. • H.264: Main profile encoding. • H.264B: Baseline profile encoding. This setting requires higher bit stream compared with other settings for the same definition.
Resolution	In the Resolution list, select resolution for the video. The maximum video resolution might be different dependent on your device model.
Frame Rate (FPS)	Configure the frames per second for the video. The higher the value is, the clearer and smoother the image will become. Frame rate changes along with the resolution. Generally, in PAL format, you can select the value from 1 through 25; in NTSC format, you can select the value from 1 through 30. However, the actual range of frame rate that you can select depends on the capability of the Device.
Bit Rate Type	In the Bit Rate Type list, select CBR (Constant Bit Rate) or VBR (Variable Bit Rate). If you select CBR , the image quality cannot be configured; if you select VBR , the image quality can be configured.
Quality	This function is available if you select VBR in the Bit Rate List. The bigger the value is, the better the image will become.
I Frame Interval	The interval between two reference frames.
Bit Rate (Kb/S)	In the Bit Rate list, select a value or enter a customized value to change the image quality. The bigger the value is, the better the image will become.

Step 3 Click **More**.

The **More** interface is displayed. See Figure 4-57.

Figure 4-57

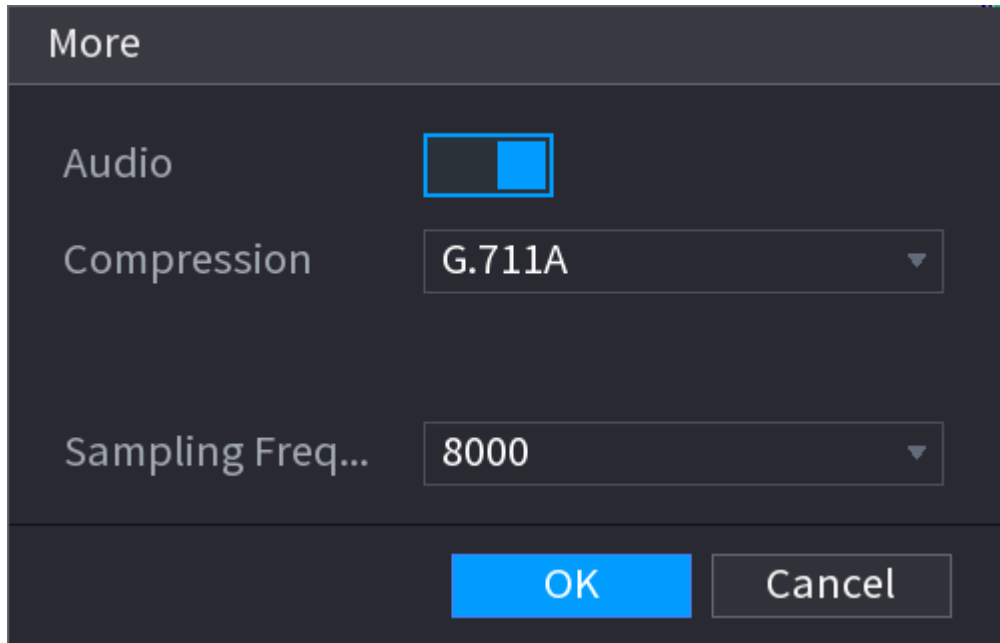

Step 4 Configure parameters. See Table 4-17.

Table 4-17

Parameter	Description
Audio	This function is enabled by default for main stream. You need to manually enable it for sub stream 1. Once this function is enabled, the recorded video file is composite audio and video stream.
Compression	In the Compression list, select a format: G711a, G711u, PCM, AAC.
Sampling Frequency	In the Sampling Frequency list, you can select audio sampling rate.

Step 5 Click **OK**.

Step 6 Click **Apply**.

4.2.6.2 Snapshot

Background Information

You can set snapshot mode, image size, quality and interval.

Procedure

Step 1 Select **Main Menu > Camera > Encode > Snapshot**
The **Snapshot** interface is displayed. See Figure 4-58.

Figure 4-58

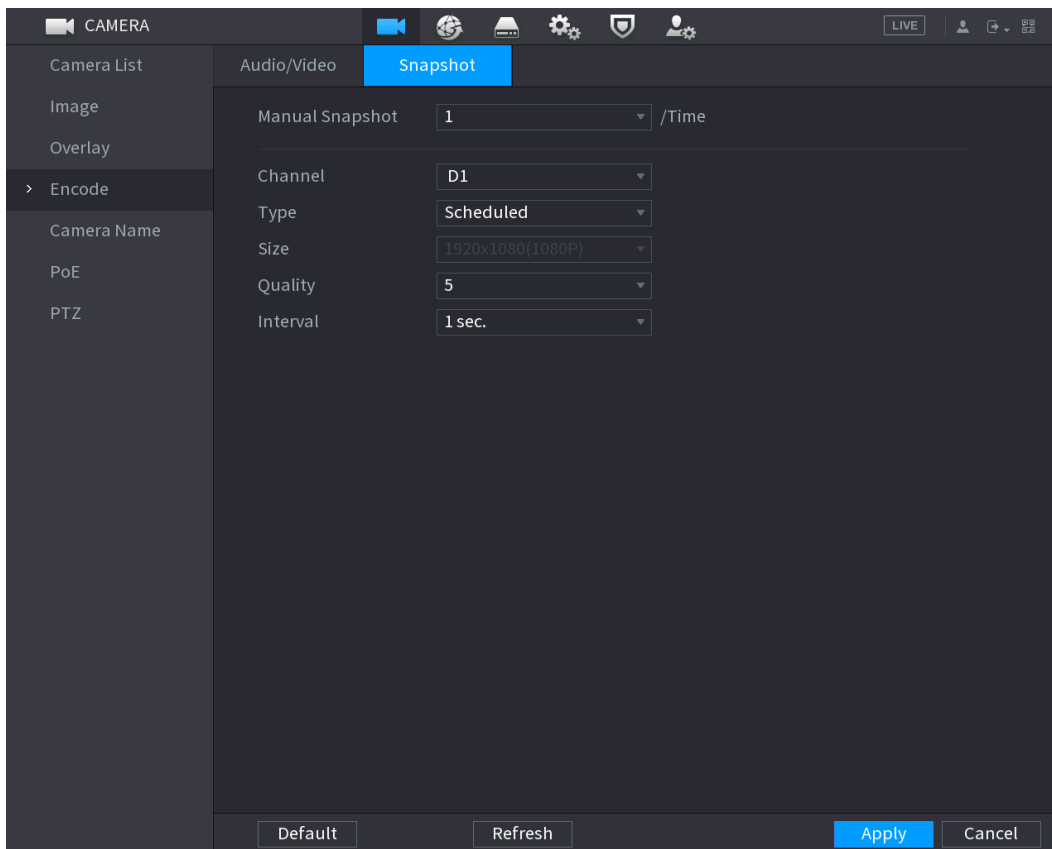

Step 2 Configure parameters. See Table 4-18.

Table 4-18

Parameter	Description
Manual Snapshot	In the Manual Snapshot list, select how many snapshots you want to take each time.
Channel	In the Channel list, select the channel that you want to configure the settings for.
Type	In the Type list, you can select Scheduled , or Event . <ul style="list-style-type: none"> • Scheduled: The snapshot is taken during the scheduled period. • Event: The snapshot is taken when there is an alarm event occurs, such as motion detection event, video loss, and local alarms.
Size	In the Size list, select a value for the image. The bigger the value is, the better the image will become.
Quality	Configure the image quality by 6 levels. The higher the level is, the better the image will become.
Interval	Configure or customize the snapshot frequency. Max. supports 3600 seconds/image.

Step 3 Click **Apply**.

4.2.7 Channel Name

Background Information

You can customize channel name.

Procedure

- Step 1** Select **Main Menu > Camera > Camera Name**.
The **Camera Name** interface is displayed. See Figure 4-59.

Figure 4-59

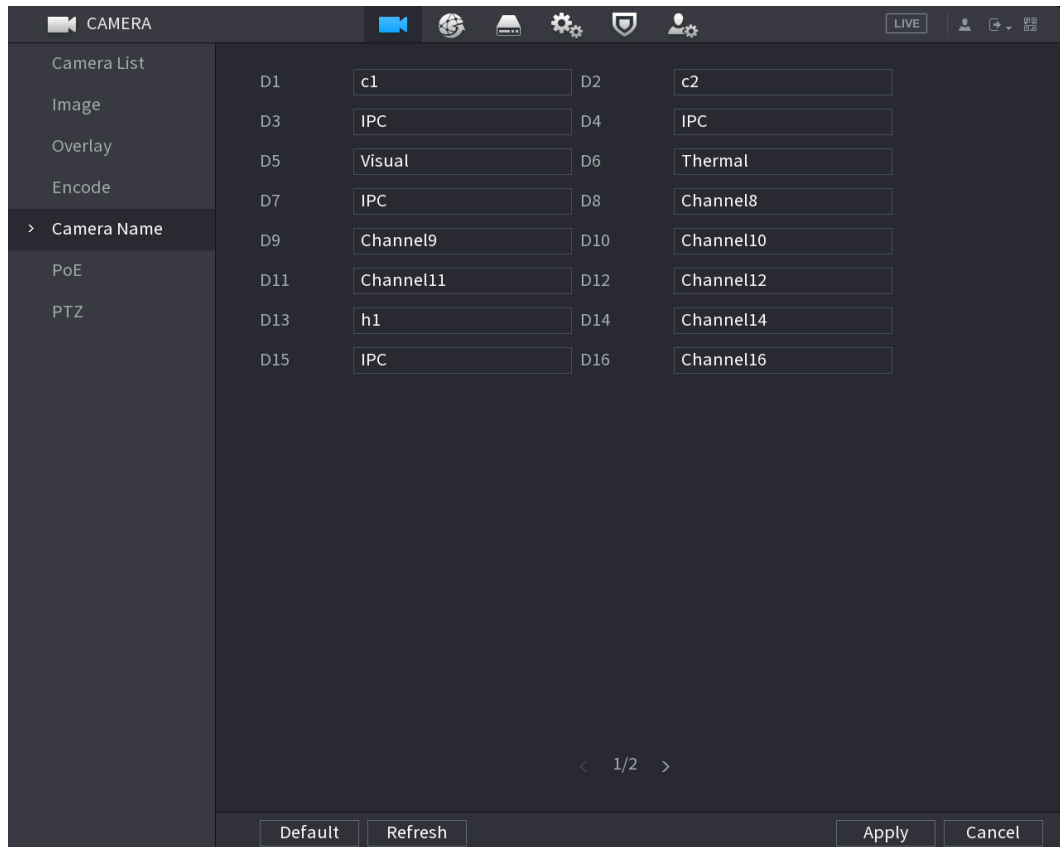

- Step 2** Modify a channel name.



- You can only change the camera connected via the private protocol.
- The channel name supports 63 English characters.

- Step 3** Click **Apply**.

4.2.8 Checking PoE Status

You can check PoE ports status and set enhancement mode for each individual PoE port.

Procedure

- Step 1** Select **Main Menu > Camera > Camera List > PoE**.

Figure 4-60

Connected/Total 0/4 Actual/Total Power(W) 0.0/39.6

Status	Port	Enhancemen...	Rate(Mbps)	Power(W)
	1	On	-	-
	2	Off	-	-
	3	Off	-	-
	4	Off	-	-

Note:

1. About icon: for PoE connection status, green circle means the device is connected and red circle means the device is disconnected;
2. Power protection function: Once the system detects the connected total power consumption exceeds the threshold, it begins to disconnect device one by one according to the port number (N - 1). System stops disconnecting when the total power consumption is restored to rated power.

Step 2 (Optional) Set **Enhancement Mode** to **On** or **Off**.



When **On** is selected, the transmission distance of PoE port will be extended.

4.2.9 Remote Update

Background Information

You can upgrade the connected network camera firmware. It includes online upgrade and file upgrade.

Procedure

Step 1 Select **Main Menu > Camera > Camera List > Update**.

The **Update** interface is displayed. See Figure 4-61.

Figure 4-61

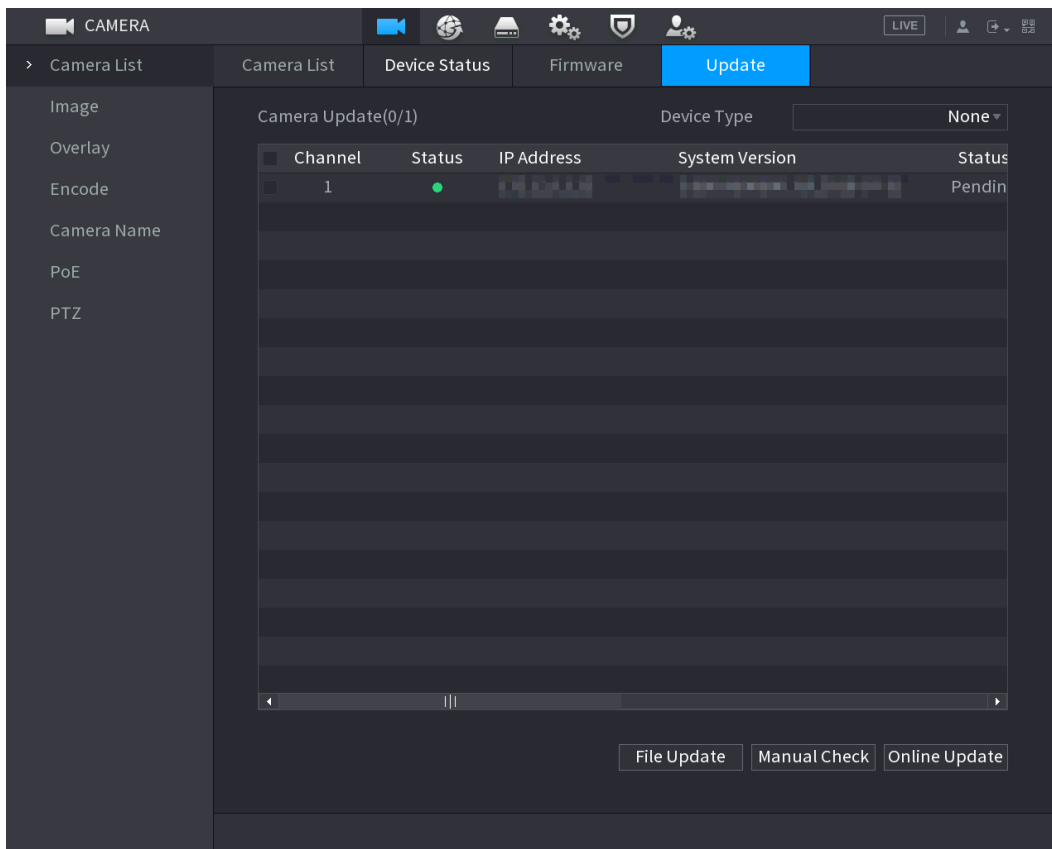

Step 2 Update the firmware of the connected remote device.

- Online Upgrade
 1. Select a remote device and then click **Manual Check**.
System detects the new version on the cloud.
 2. Select a remote device that has new version and then click **Online Update**.
After successful operation, system prompts update successful dialogue box.
- File upgrade
 1. Select a channel and then click **File Update**.
 2. Select update file on the pop-up interface.
 3. Select the update file and then click **OK**.
After successful operation, system prompts update successful dialogue box.



If there are too many remote devices, select **Device Type** from the drop-down list to search the remote device as needed.

4.2.10 Remote Device Info

4.2.10.1 Device Status

You can view the connection and alarm status of the corresponding channel.

Select **Main Menu > Camera > Camera List > Device Status**, the **Device Status** interface is displayed. See Figure 4-62. Refer to Table 4-19 for detailed information.

Figure 4-62

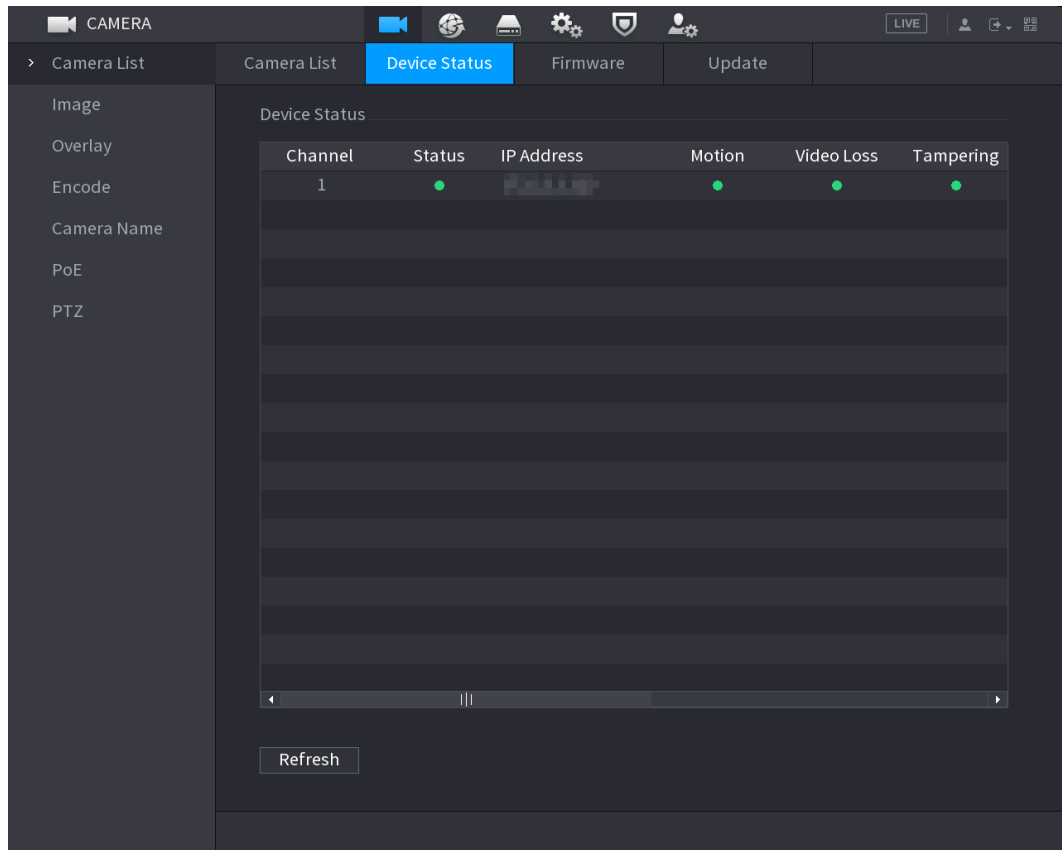

Table 4-19

Icon	Description	Icon	Description
	IPC works properly.		IPC does not support.
	There is an alarm.		Video loss occurs.

4.2.10.2 Firmware

You can view IP address, manufacturer, type, system version of the connected remote device. Select **Main Menu > Camera > Camera List > Firmware**, the Firmware interface is displayed. See Figure 4-63.

Figure 4-63

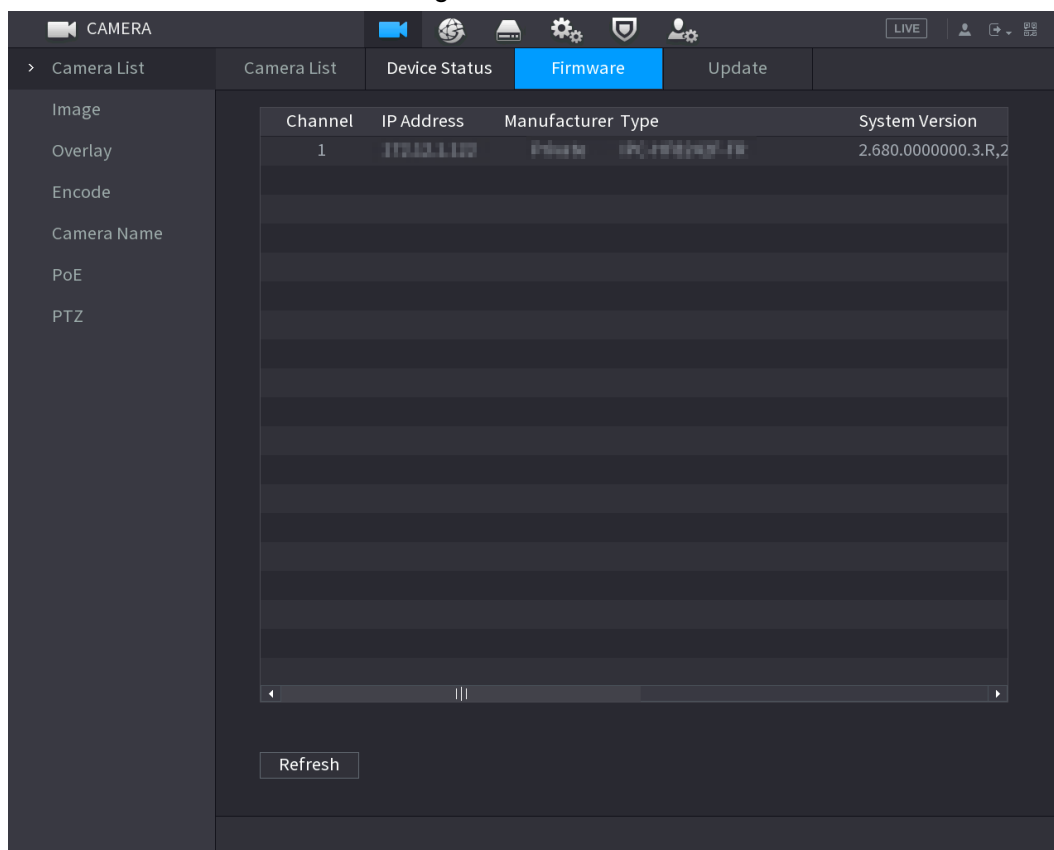

4.3 Live View

After you logged in, the system goes to multiple-channel live view mode by default. You can view the monitor video of each channel.

The displayed window amount may vary. The actual product shall prevail.

4.3.1 Live View

On the live view interface, you can view the monitor video of each channel. The corresponding channel displays date, time, and channel name after you overlay the corresponding information. Refer to the following table for detailed information. See Table 4-20.

Table 4-20

SN	Icon	Description
1		When current channel is recording, system displays this icon.
2		When motion detection alarm occurs, system displays this icon.
3		When video loss alarm occurs, system displays this icon.
4		When current channel is in monitor lock status, system displays this icon.

SN	Icon	Description
5		When the device connects to the network camera remotely, system displays this icon. This function is for some series products only.

4.3.2 Navigation bar

Background Information

You can quickly perform operation through the icon on the navigation bar.



- Different series products may display different navigation bar icons. Refer to the actual product for detailed information.
- Select **Main Menu > SYSTEM > General > Basic** to enable navigation bar function and then click **Apply**; otherwise you cannot see the following interface.







Click the live view interface. You can see navigation bar. See Figure 4-64. Refer to Table 4-21 to view detailed information.

Figure 4-64



Table 4-21

Icon	Function
	Open Main Menu .
	Expand or condense the navigation bar.
	Select view layout.
	Go to the previous screen.
	Go to the next screen.
	Enable tour function. The icon switches to . Close the tour or the triggered tour operation has canceled, and device restores the previous preview video.
	Open the PTZ control panel . For details, see "4.4.2 PTZ Control".
	Open the Color Setting interface. For details, see "4.4.2 PTZ Control". This function is supported only in single-channel layout.
	Open the record search interface. For detail, see "4.6.2 Search Interface".

Icon	Function
	Open the Voice Broadcast interface. For detail, see "4.17.3 Broadcast".
	Open the Alarm Status interface to view the device alarm status. For details, see "4.8.2 Alarm Status".
	Open the Channel Info interface to display the information of each channel. For details, see "4.3.2.1 Channel Info".
	Open the Add Camera interface. For details, see "4.1.4.4 Adding Camera".
	Open the NETWORK interface. For details, see "4.10.3 Network".
	Open the Disk Manager interface. For details, see "4.12.3 Disk Manager".
	Open the USB Management interface. For details about USB operations, see "4.3.2.2 USB Management".

4.3.2.1 Channel Info

After the remote device registered to the corresponding channel, you can view its status such as alarm status, record status, connection status, record mode, etc.

- Alarm status: It includes motion detection alarm, video loss alarm, tampering alarm.
- Record status: System is recording or not.
- Bit Rate: System displays bit rate information.
- Status: current channel connection status.

Click , system goes to the channel information setup interface. You can view information of the corresponding channel. See Figure 4-65.

Figure 4-65

Channel Info

Cha...	Motion De...	Video ...	Tampering	Record St...	Bit Rate(...	Status	Record ...
D1	--	--	--	--	4147	●	Pre-record
D2	--	--	--	--	0	●	Pre-record
D3	--	--	--	--	1712	●	Pre-record
D4	--	--	--	--	7808	●	Pre-record
D5	--	--	--	--	0	●	Pre-record
D6	--	--	--	--	0	●	Pre-record

|||

Refresh

4.3.2.2 USB Management

After connecting the USB device, you can copy log, config file to USB device or update NVR system.

Click , system goes to **USB Management** interface. You can view and manage USB information. See Figure 4-66.

Here you can view USB information, back up file, and update system. Refer to [File Backup](#), "4.10.1 Log", "4.10.4.4 System Update" for detailed information.

Figure 4-66

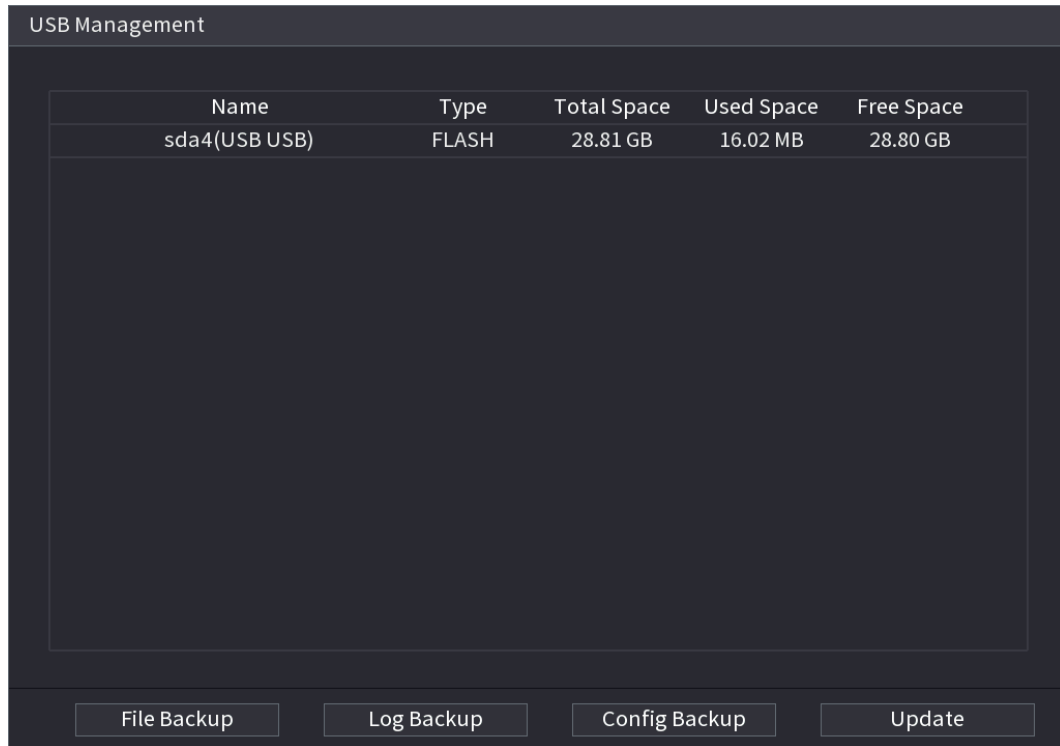

Name	Type	Total Space	Used Space	Free Space
sda4(USB USB)	FLASH	28.81 GB	16.02 MB	28.80 GB

File Backup Log Backup Config Backup Update

4.3.3 Live View Control Interface

Move your mouse to the top center of the video of current channel; you can see system pops up the live view control interface. See Figure 4-67.

If your mouse stays in this area for more than 6 seconds and has no operation, the control bar automatically hides.



- Disable the navigation bar if it is displayed on the interface before using this function.
- The live view control interface is different depending on the model, and the actual interface shall prevail.

Figure 4-67



4.3.3.1 Instant Replay

You can play back the previous 5-60 minutes record of current channel.

Click  to go to the instant replay interface. See Figure 4-68.

Figure 4-68

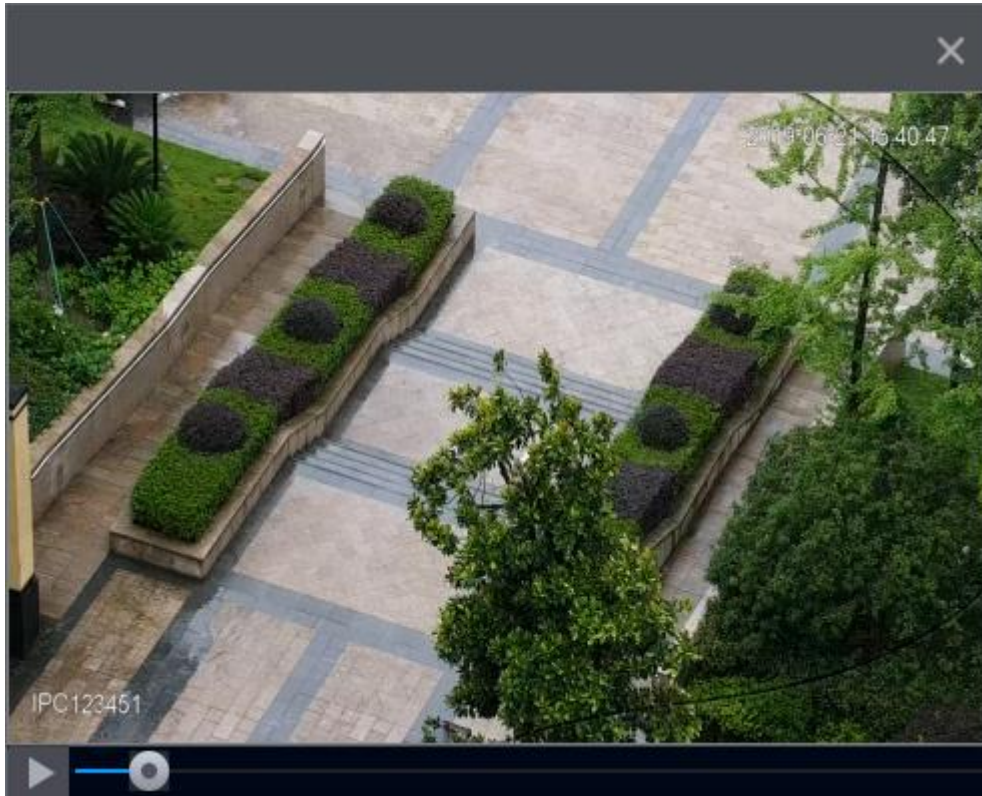

Instant replay is to playback the previous 5 minutes to 60 minutes record of current channel.

- Move the slider to choose the time you want to start playing.
- Play, pause and close playback.
- The information such as channel name and recording status icon are shielded during instant playback and will not display until exited.
- During playback, screen split layout switch is not allowed.
- Tour high higher priority than the instant playback. The instant playback function is null when tour function is in process and the preview control interface auto hides either. The function becomes valid again after tour is complete.



Go to the **Main Menu > SYSTEM > General > Basic** to set Instant Replay time. See Figure 4-69. System may pop up a dialogue box if there is no such record in current channel.

Figure 4-69

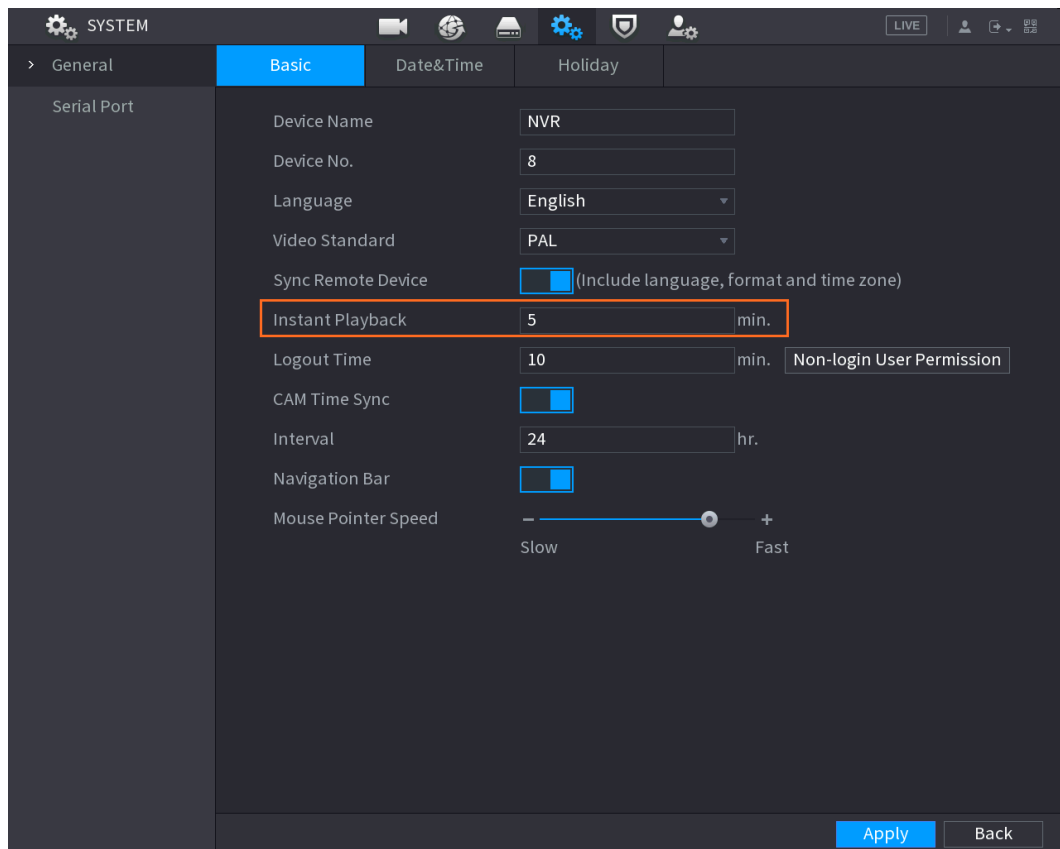

4.3.3.2 Digital Zoom

You can zoom in specified zone of current channel so that you can view the details. It supports zoom in function of multiple-channel. It includes the following two ways:

- Click , the icon switches to . Hold down the left mouse button to select the area you want to enlarge. The area is enlarged after the left mouse button is released.
- Point to the center that you want to enlarge, rotate the wheel button to enlarge the area.



For some models, when the image is enlarged in the first way described previously, the selected area is zoomed proportionally according to the window.

The digital zoom interface is shown as in Figure 4-70. When the image is in the enlarged status, you can drag the image toward any direction to view the other enlarged areas. Right click mouse to cancel zoom and go back to the original interface.

Figure 4-70

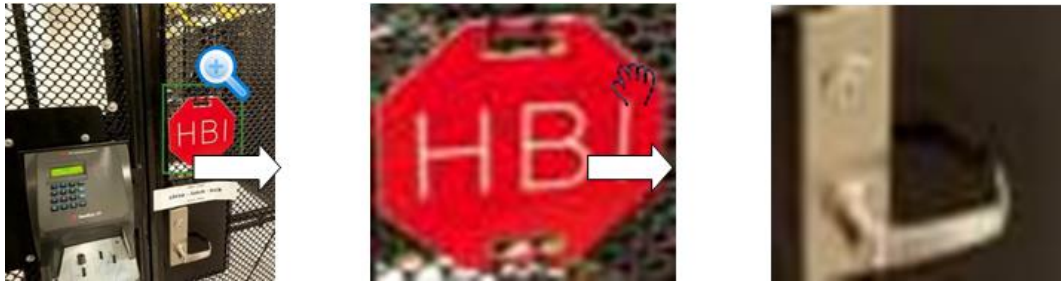

4.3.3.3 Instant Backup

You can record the video of any channel and save the clip into a USB storage device. By clicking , the recording is started. To stop recording, click this icon again. The clip is automatically saved into the connected USB storage device. You can record the video of any channel and save the clip into a USB storage device.

4.3.3.4 Manual Snapshot

You can take one to five snapshots of the video and save into a USB storage device. By clicking , you can take snapshots. The snapshots are automatically saved into the connected USB storage device. You can view the snapshots on your PC.





To change the quantity of snapshots, select **Main Menu > CAMERA > Encode > Snapshot**, in the **Manual Snapshot** list, select the snapshot quantity.

4.3.3.5 Two-way Talk

Background Information

You can perform the voice interaction between the Device and the remote device to improve efficiency of emergency.

Procedure

- Step 1** Click  to start two-way talk function the icon now is shown as . Now the rest two-way talk buttons of digital channel becomes null too.
- Step 2** Click  again, you can cancel two-way talk.

4.3.3.6 Switch Bit Streams

Via this function, you can switch the channel main stream/sub stream according to current network bandwidth.

- M: Main stream. Its bit streams are big and definition is high. It occupies large network bandwidth suitable for video wall surveillance, storage and etc.
- S: Sub stream. Its definition is low but occupies small network bandwidth. It is suitable for general surveillance, remote connection and etc.

Click  to switch the bit stream type of the main stream and sub stream.

- M: Main stream.
- S: Sub stream. Some series products support two sub streams (S1, S2). Refer to "4.2.6.1

Encode" for detailed information.

4.3.3.7 Shortcut Menu

By right-clicking on the live view interface, you can quickly access the corresponding functional interface and perform relevant operations, including entering the main menu, searching records and selecting screen split mode.

Right-click on the live interface and the shortcut menu is displayed. Refer to Table 4-22 for detailed information.



The shortcut menu is different for different models. The actual interface shall prevail.

Table 4-22

Function	Description
Main Menu	Open Main Menu interface.
Search	Open the SEARCH interface where you can search and play back record files. For details, see "4.6 Playback and Search".
PTZ Control	Open the PTZ interface. For details, see "4.4 PTZ".
View 1/4/8/9/16/25/36	Configure the live view screen as a single-channel layout or multi-channel layout.
Sequence	Set customized screen split mode and channels. For details, see "4.3.5 Sequence".
Add Camera	Open the Add Camera interface. For details, see "4.1.4.4 Adding Camera".
Wireless Paring	Right-click Wireless Paring to quickly add IPCs. For details, see "4.3.4 Wireless Paring".
Split Track	Split the screen of a certain channel. For details, see "4.3.9 Split Tracking".
Manual Control	<ul style="list-style-type: none"> Select Record Mode, you can configure the recording mode as Auto or Manual, or stop the recording. You can also enable or disable snapshot function Select Alarm Mode, you can configure alarm output settings.
Live Mode	There are two modes: General/AI mode.
Crowd Distribution	Select enable/disable to start/stop crowd distribution function.
Auto Focus	Click to realize auto focus function. Make sure the connected camera supports auto focus function.
Image	Click to modify the camera properties. For details, see "4.2.4 Image".
Sub Screen	Click Sub Screen , you can go to control the sub screen.

4.3.3.8 Picture Search

Background Information

Select the image of target person on the live view interface and then search by image for all

the related videos with the target person.

Procedure

Step 1 Click , and the live image is frozen.

Step 2 Draw a searching range by the way that is instructed by onscreen prompt, and then click **OK**.

- If there are less than 30 faces in the selected range, the searching starts immediately.
- If there are more than 30 faces, human bodies, and vehicles in the selected range, a prompt is displayed indicating that there are too many targets and the searching range should be reduced. The image stays frozen and you can start modifying range.

Figure 4-71 Draw a searching range

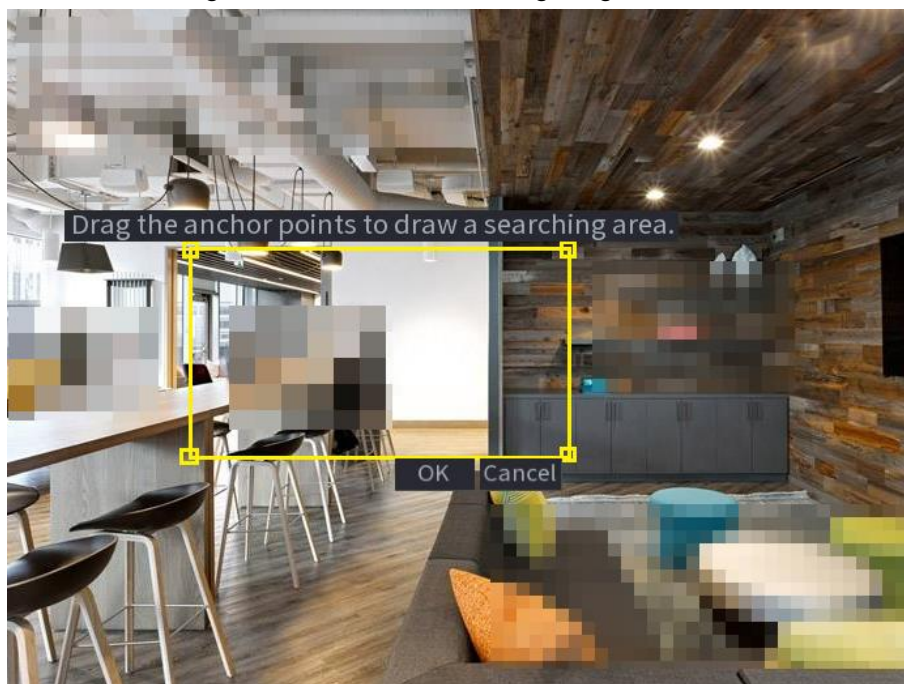





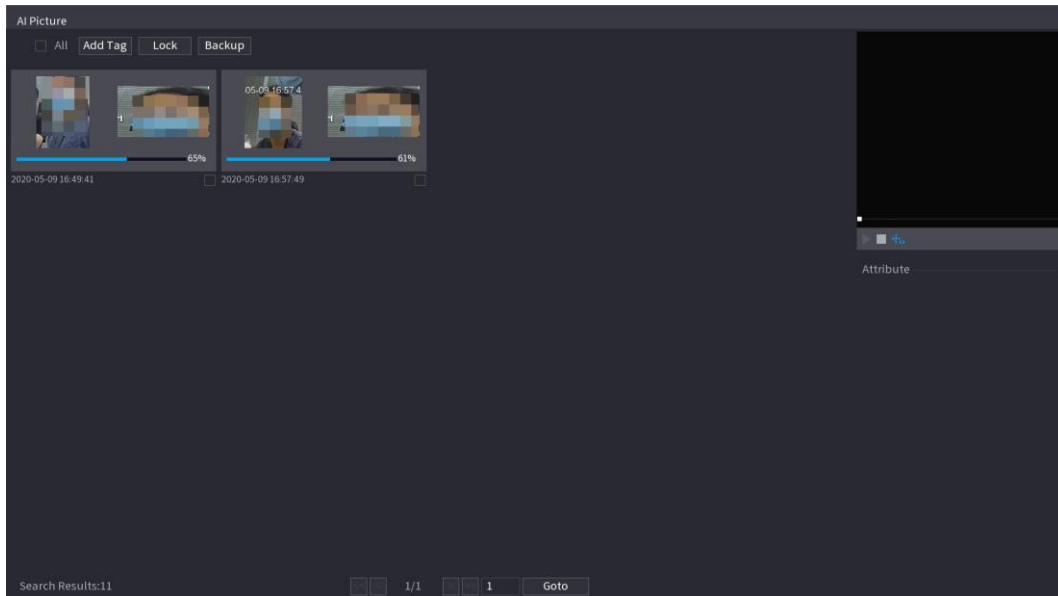

Step 3 Select the target face that you want to search for related videos and configure parameters. You can select maximum 8 target faces.

Step 4 Click **Search**. The search results are displayed.

Figure 4-72 Picture search results



- Play video: Select the picture and then click  to play back the video within 10 seconds before and after the snapshot. During playback, you can click  to pause, click  to stop, and click  to display or hide the intelligent rules ( means displaying and  means not displaying).
- Add tag: Select the picture and then click **Add Tag** to add a tag to the recorded video to find the target recorded video more fast. For details, see "4.6.5 Tag Playback".
- Lock recorded video: If you want to keep the recorded video permanently, select the picture, and then click **Lock** to lock video so that it cannot be overwritten and deleted.
- Back up recorded video or picture: Select the picture, and then click **Backup**. The **Backup** interface is displayed. Then you can set save path, backup type, and file type, and then export to the external storage device.

4.3.4 Wireless Paring

Right-click on the screen and select **Wireless Paring**. The **Wireless Paring** interface is displayed. See Figure 4-73.

The device enters a 120 seconds pairing countdown.

You can see the video of the paired IPC after pairing is successful.

Figure 4-73

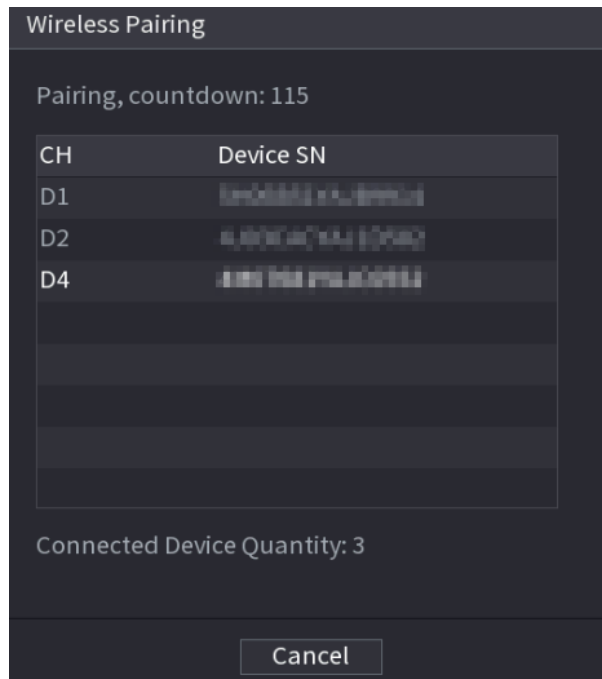

4.3.5 Sequence

Background Information

You can set customized view layout.



The preview layout restores default channel layout after Default operation.

Procedure

- Step 1 On the preview interface, right click mouse and then click **Sequence**. The **Sequence** interface is displayed. See Figure 4-74.



- Enter edit view interface, device automatically switches to the max split amount mode.
- The channel list on the edit view interface displays the added camera channel number and channel name. ● means camera is online. ● means camera is offline.
- In case the channel amount has exceeded the device max split amount, the edit view interface can display the max screen number amount and current screen number.

Figure 4-74

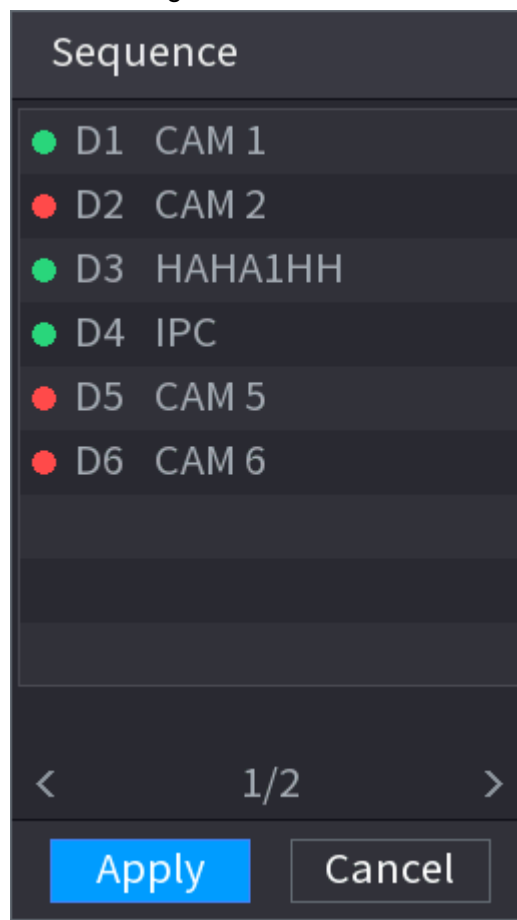

Step 2 On the edit view interface, drag the channel to the desired window, or drag on the preview window to switch the position.
Check the channel number at the right bottom corner to view the current channel sequence. See Figure 4-75.

Figure 4-75

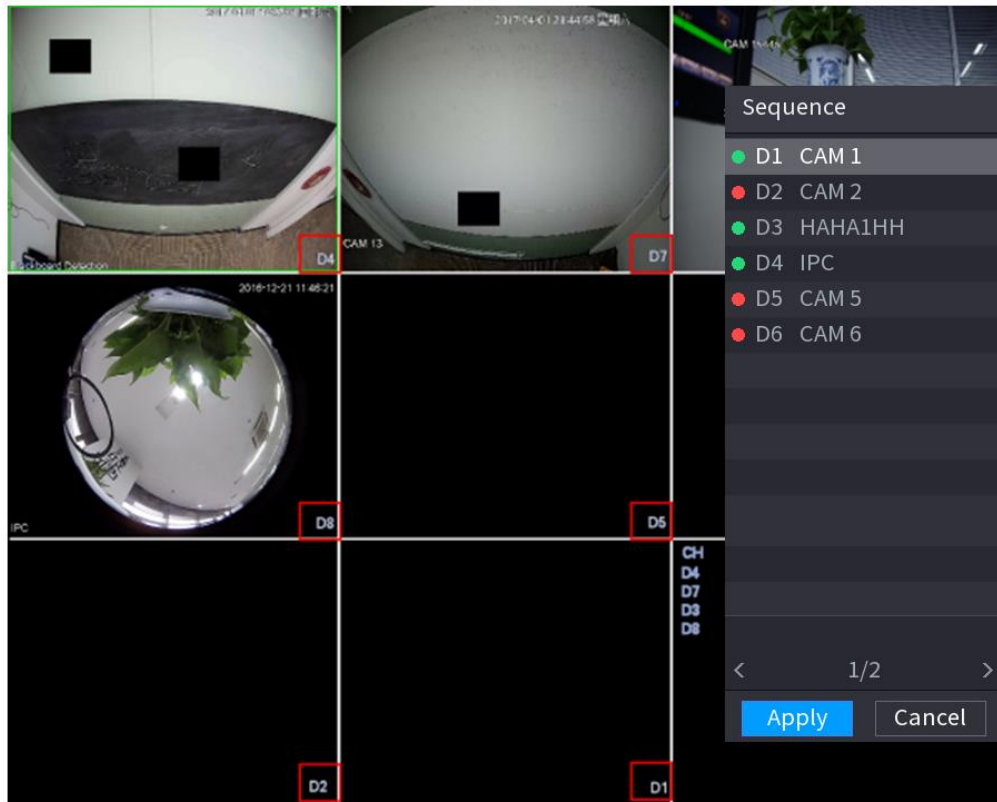

- Step 3** Click **Apply** to save current channel sequence.
 After you change the channel sequence, click **Cancel** or right-click the live view interface, device pops up the dialogue box. See Figure 4-76.
- Click **OK** to save current settings.
 - Click **No** to exit without saving the settings.

Figure 4-76

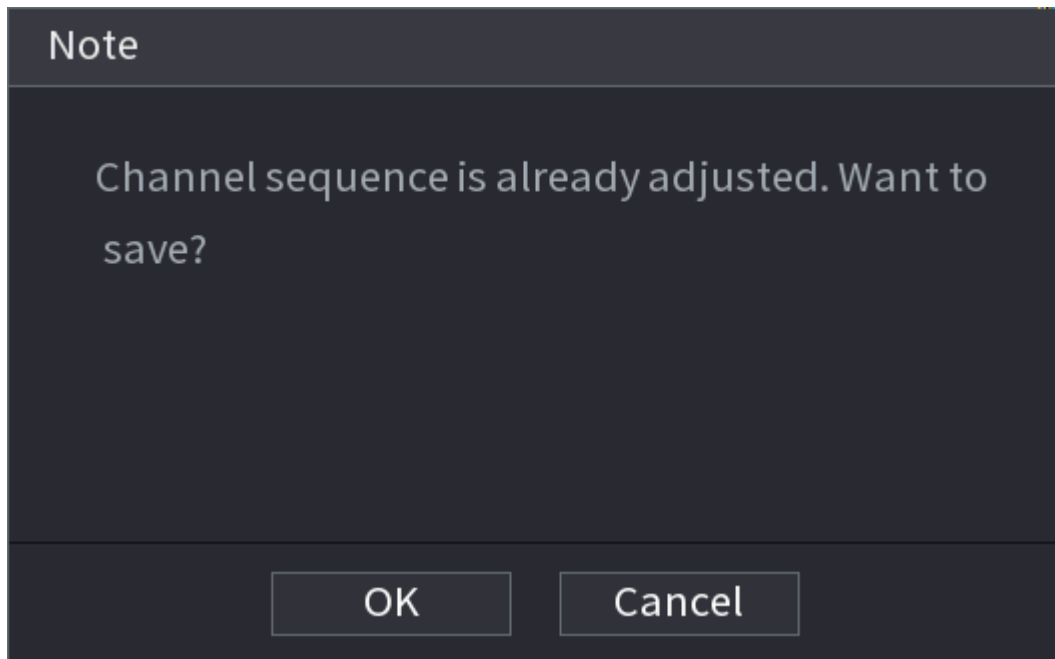

4.3.6 Fisheye (Optional)

This function is for some series products only.

4.3.6.1 Fisheye De-warp on Live View Interface

The fisheye camera (panoramic camera) has wide video of angle but its video is seriously distorted. The de-warp function can present the proper and vivid video suitable for human eyes.

On the live view interface, select fisheye channel and then right click, you can select fish eye. See Figure 4-77. You can set fisheye installation mode and display mode.



- For the non-fish eye channel, system pops up dialogue box to remind you it is not a fish eye channel and does not support de-warp function.
- If system resources are insufficient, system pops up the corresponding dialogue box too.

Figure 4-77

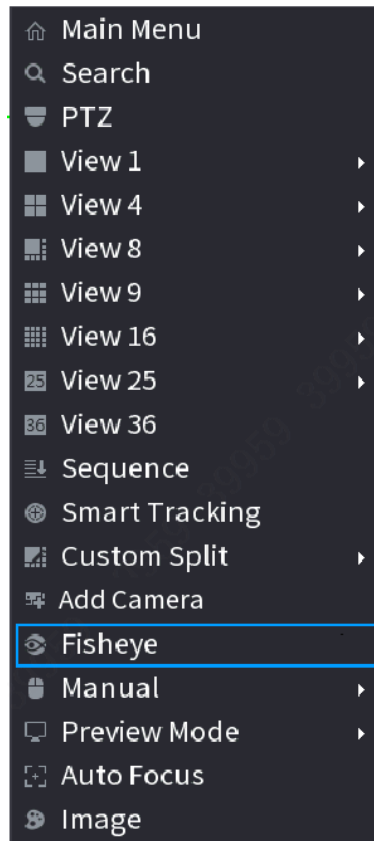

Now you can see an interface shown as in Figure 4-78. You can set fish eye installation mode and display mode. There are three installation modes: ceiling mount/wall mount/ground mount.



- The different installations modes have different de-warp modes.
- Some series products support 180°de-warp. 180°de-warp fisheye supports wall mount de-warp only. The actual product shall prevail.

Figure 4-78

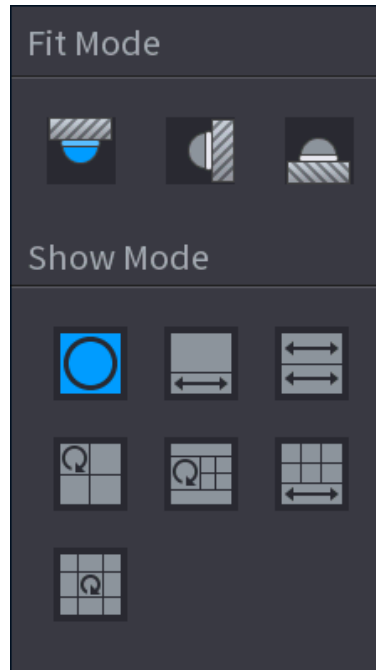

Refer to the following sheet for detailed information. See Table 4-23.

Table 4-23















Installation modes	Icon	Note
 (Wall mount)  (Ground mount)		360°panorama original view
		1 de-warp window+1 panorama stretching
		2 panorama stretching view
		1 360° panorama view+3 de-warp windows
		1 360°panorama view+4 de-warp windows
		4 de-warp windows+1 panorama stretching
		1 360° panorama view+8 de-warp windows
 (Wall mount)		360°panorama original view
		Panorama stretching
		1 panorama unfolding view+3 de-warp windows
		1 panorama unfolding view +4 de warp windows
		1 panorama unfolding view +8 de warp windows

Figure 4-79



In Figure 4-79, you can adjust the color pane on the left pane or use your mouse to change the position of the small images on the right pane to realize fish eye de-warp.



Operation: Use mouse to zoom in/zoom out, move, and rotate the image (Not for wall mount mode.)

4.3.6.2 Fisheye De-warp During Playback

Background Information

When playing back the fisheye record file, you can use de-warp function to adjust video.

Procedure

- Step 1 On the main menu, click **BACKUP**.
- Step 2 Select 1-window playback mode and corresponding fish eye channel, click  to play.
- Step 3 Right click the , you can go to the de-warp playback interface. For detailed information, refer to Figure 4-79.

4.3.7 Test Temperature

When connecting to the front-end device that supports temperature detection, system can display instant temperature.



- This function may collect the human temperature in the surveillance video, be careful.
- This function is for some series products only.

Preparations

Refer to "4.16.1 Display" to enable test temperature function.

On the preview window, click any position on the thermal channel video. The interface is shown as below. See Figure 4-80.

Figure 4-80

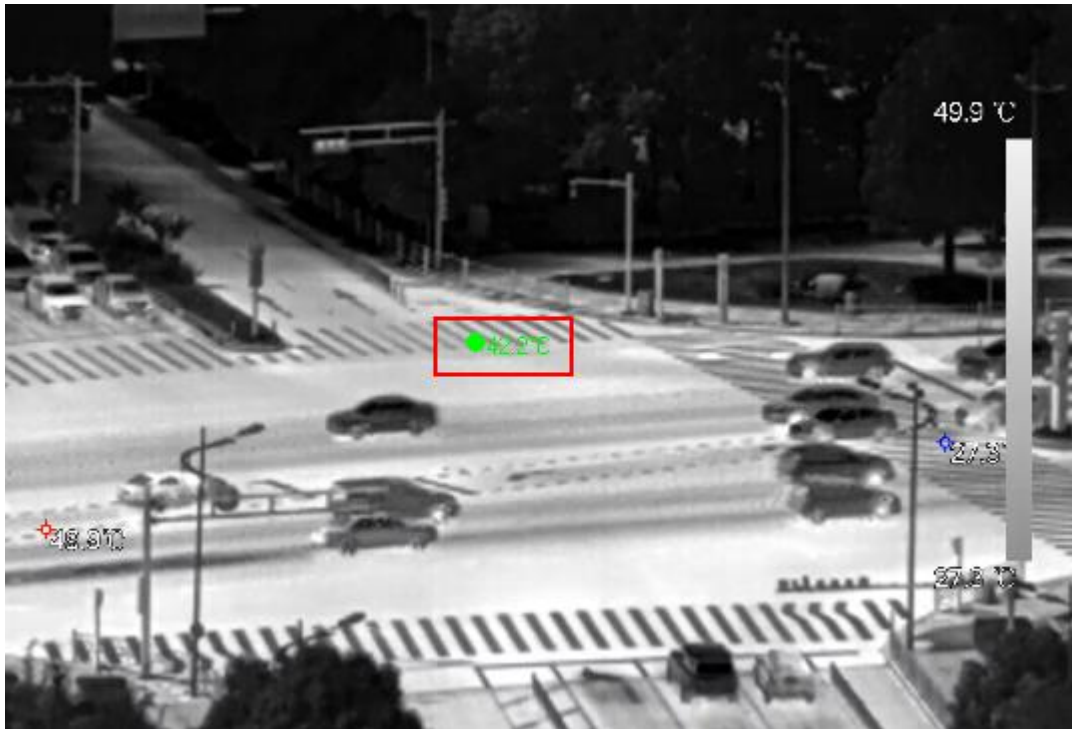

4.3.8 AI Live View Mode

Background Information

When you select AI mode, the system displays information of human face, personnel, vehicle and non-motor vehicle on the right side of the preview interface, and it supports to play back records and display feature attributes.



You need to enable face detection, body detection, vehicle detection and non-motor vehicle detection to support this function. For details, see "4.7.2.5 Video Metadata".

Procedure

- Step 1 Right click to select **Live Mode > AI Mode**.
The AI live view interface is displayed. See Figure 4-81.

Figure 4-81 AI live view

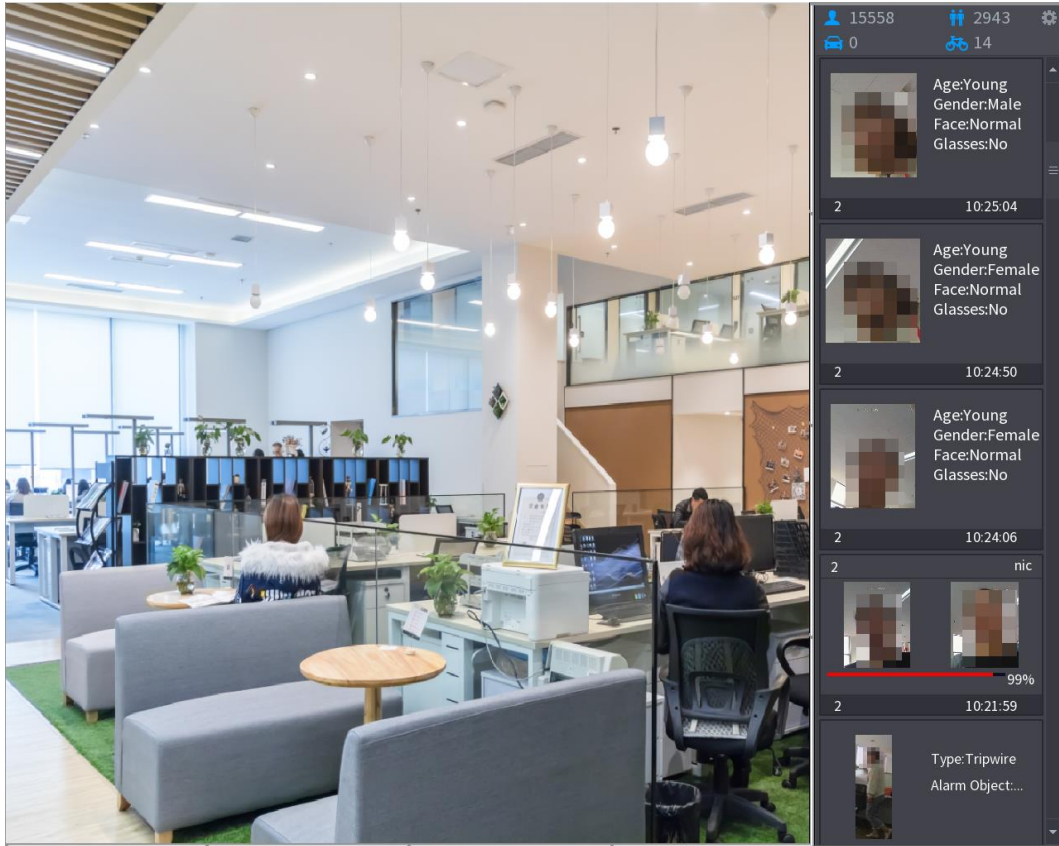

Step 2 (Optional) Double-click the image on the right to play the corresponding video.

Step 3 Click .

The Properties interface is displayed. See Figure 4-82.

Figure 4-82 Face vehicle properties

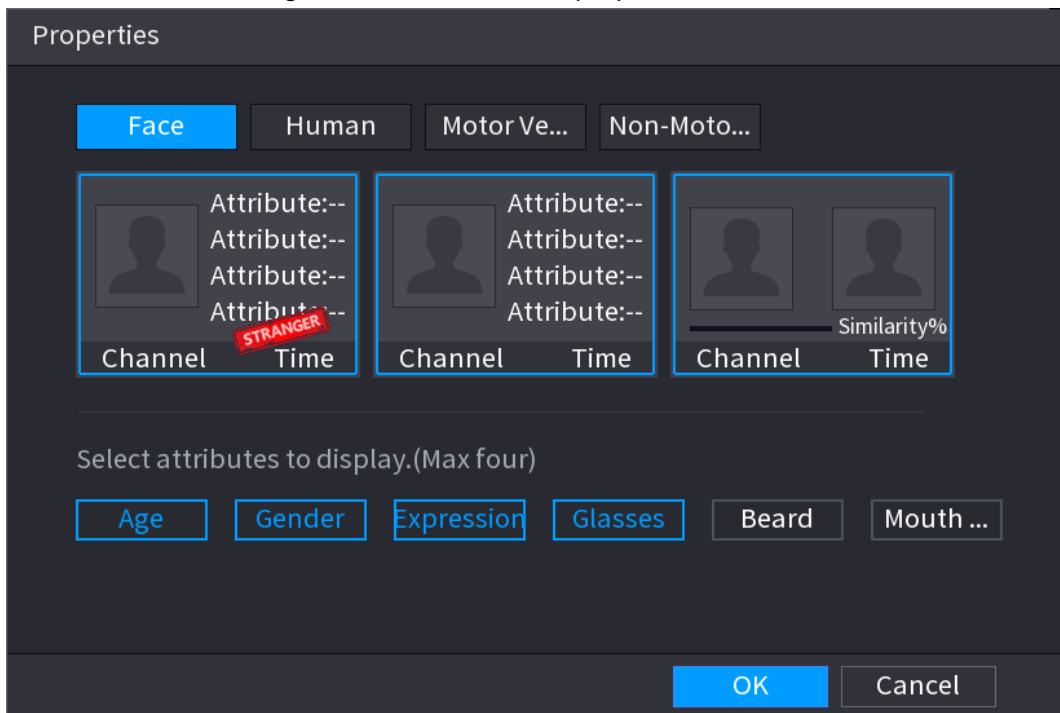

Step 4 (Optional) Click Show Face List and select attributes to display, including age, gender, expression, glasses, beard and mask.

Step 5 (Optional) Click **Human Body Detection** and select attributes to display, including

top, pants, hat, bag, bag style, umbrella, age and gender. See Figure 4-83.

Figure 4-83 Human properties

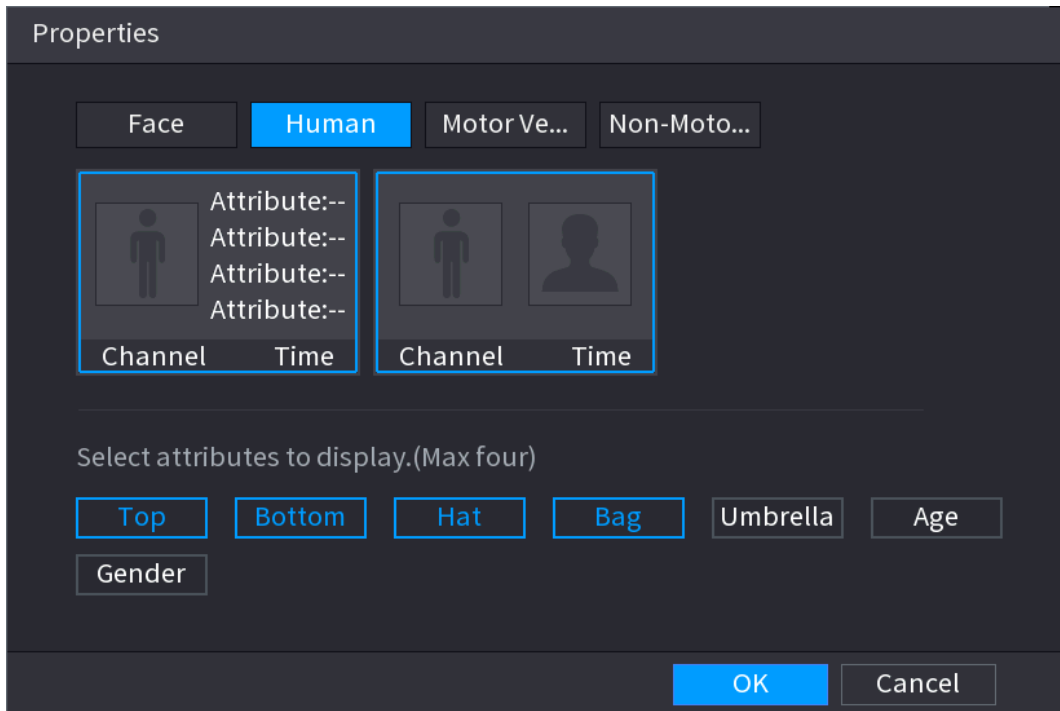

Step 6 (Optional) Click **Vehicle Display** and select attributes to display, including vehicle logo, vehicle color, vehicle model, plate recognition, plate color, seatbelt, call, vehicle decorations and countries & regions. See Figure 4-84.

Figure 4-84 Motor vehicle properties

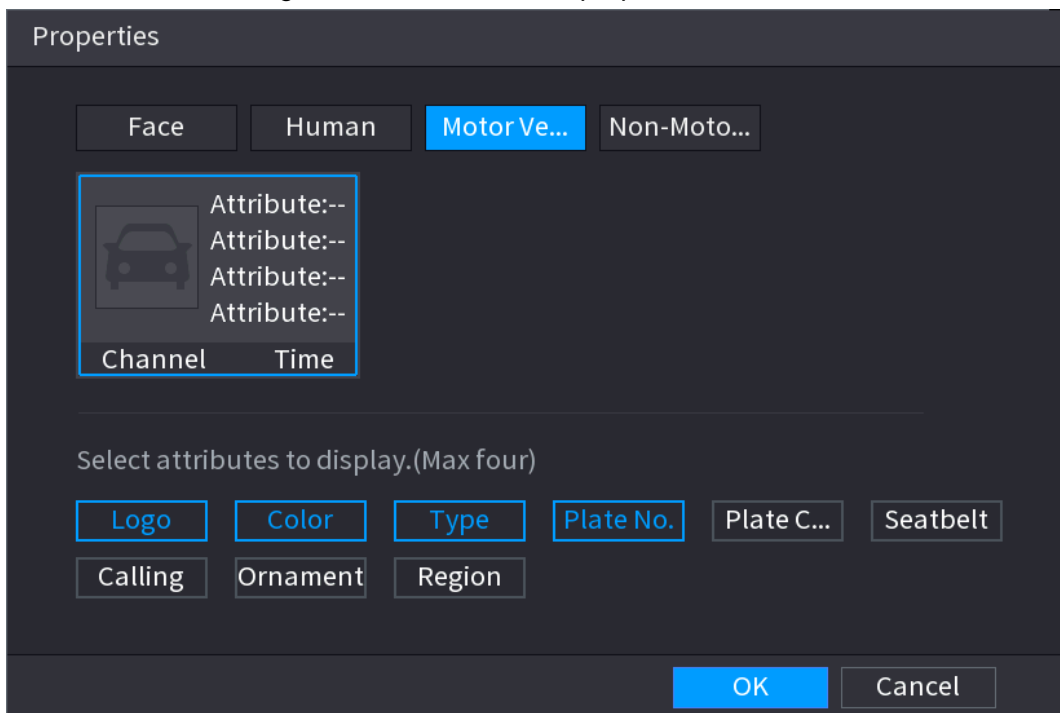

Step 7 (Optional) Click **Non-Motor** and select attributes to display, including color, type and people number. See Figure 4-85.

Figure 4-85 Non-motor vehicle properties

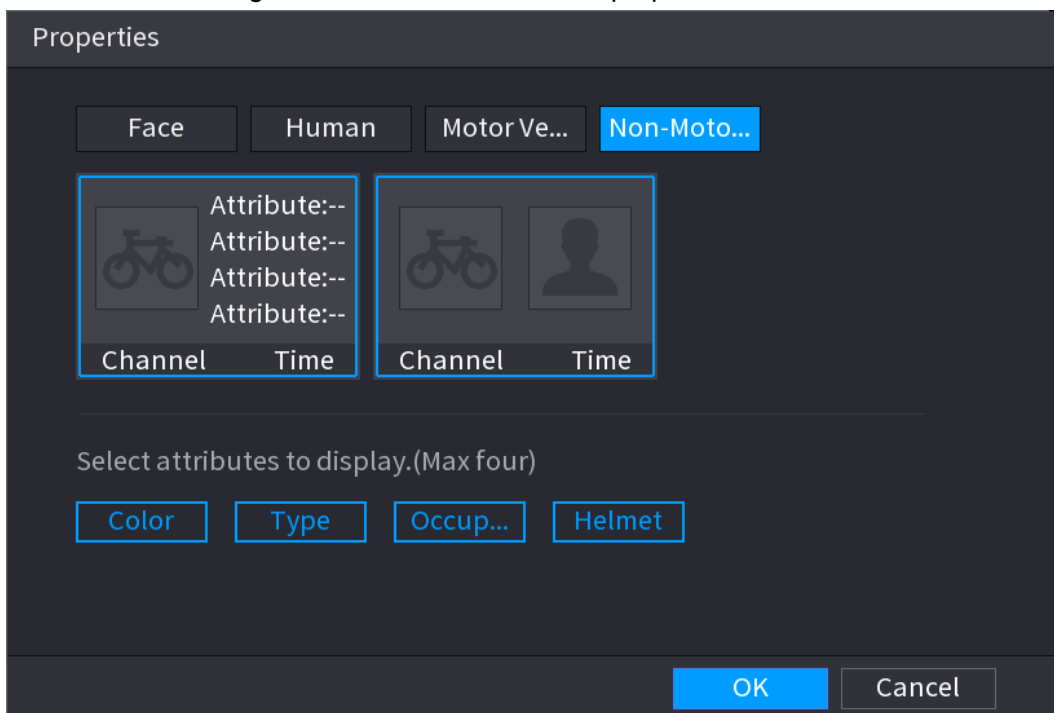

Step 8 Click **OK** to complete the setting.



The system can display four attributes at most.

4.3.9 Split Tracking

You can track window split for a certain channel.



This function is for select models only.

Procedure

Step 1 Right-click on the live view screen, and select **Split Track**.

Figure 4-86

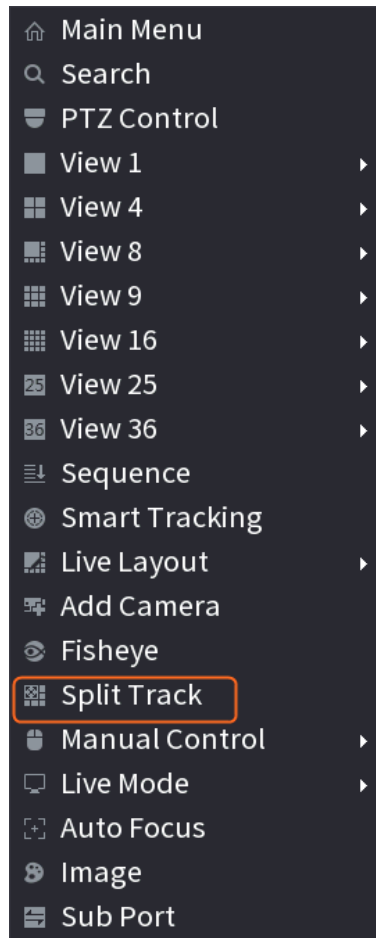

Step 2 Select a split mode.

Figure 4-87

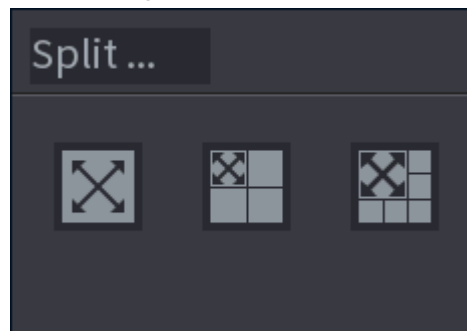

Split mode includes full screen, 1 main screen + 3 split screens and 1 main screen + 5 split screens.

- You can move the rectangles with color to adjust the videos displayed on split screens.
- You can scroll the mouse wheel in split screens to zoom in or out the video.

Figure 4-88



4.3.10 Quick Operation Bar

You can quickly access to the function modules on function tiles and setting menu through shortcut icons on quick operation bar.

This topic uses **ALARM** and **CAMERA** as examples to show you how to quickly access other modules.

Shortcut Icons on Function Titles

Click **ALARM** to enter the **ALARM** interface.

Figure 4-89

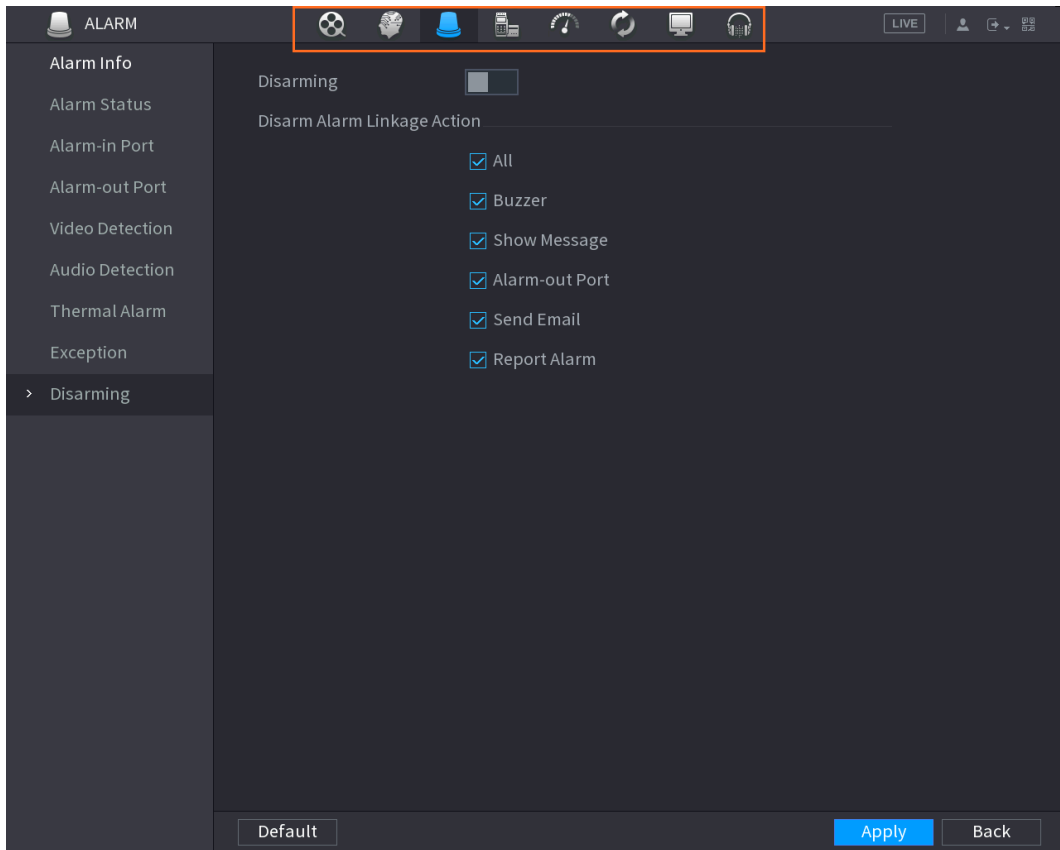

Table 4-24

Icon	Description
	Click to jump to SEARCH interface.
	Click to jump to ALARM interface.
	Click to jump to AI interface.
	Click to jump to POS interface.
	Click to jump to NETWORK interface.
	Click to jump to MAINTAIN interface.
	Click to jump to BACKUP interface.
	Click to jump to DISPLAY interface.
	Click to jump to AUDIO interface.

Shortcut Icons on Setting Menu

Click **CAMERA** to enter the **CAMERA** interface.

Figure 4-90

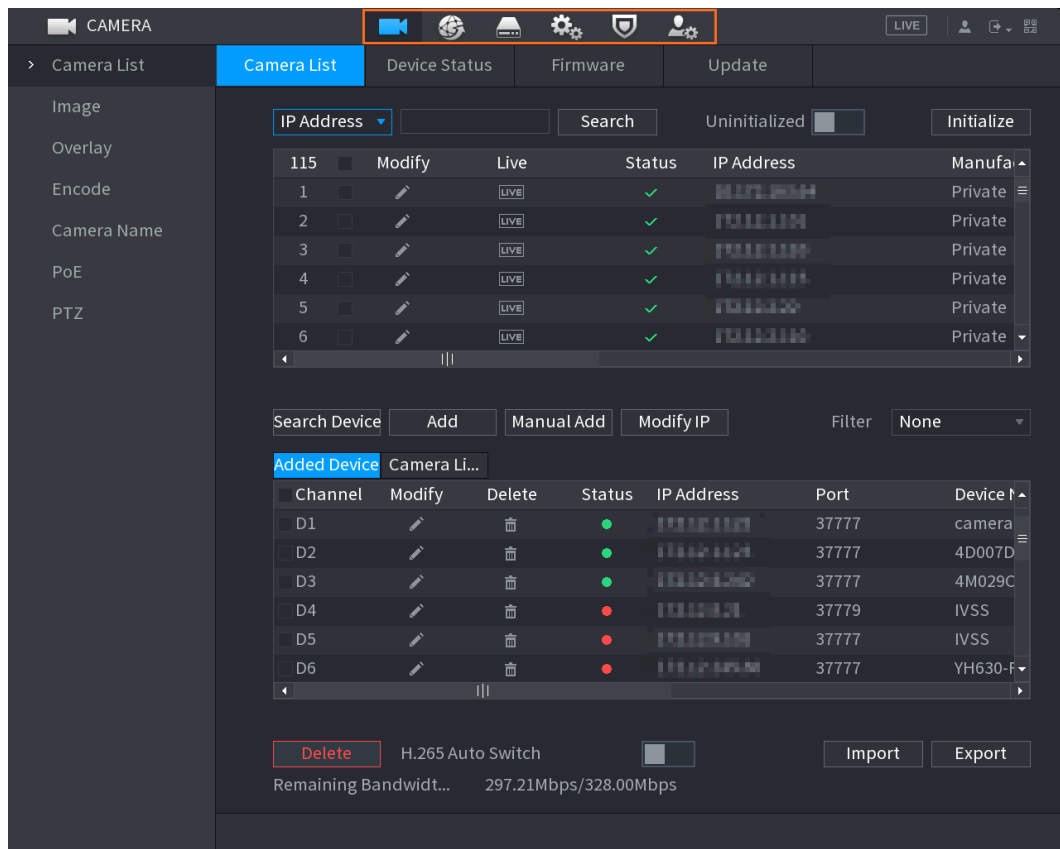

Table 4-25

Icon	Description
	Click to jump to CAMERA interface.
	Click to jump to NETWORK interface.
	Click to jump to STORAGE interface.
	Click to jump to SYSTEM interface.
	Click to jump to SECURITY interface.
	Click to jump to ACCOUNT interface.

4.4 PTZ

PTZ is a mechanical platform that carries a camera and a protective cover and performs overall control remotely. A PTZ can move in both horizontal and vertical direction to provide all-around view to the camera.



Before you control the PTZ, make sure the PTZ decoder and the NVR network connection is OK.

4.4.1 PTZ Settings

Background Information

You can set different PTZ parameters for local type and remote type. Before you use local PTZ, make sure you have set PTZ protocol; otherwise you cannot control the local PTZ.

- Local: The PTZ device connects to the NVR through the cable.
- Remote: The PTZ device connects to the NVR through the network.



This function is for some series products only.

Procedure

Step 1 Select **Main menu > Camera > PTZ**.

The **PTZ** interface is displayed. See Figure 4-91 or Figure 4-92. Figure 4-91

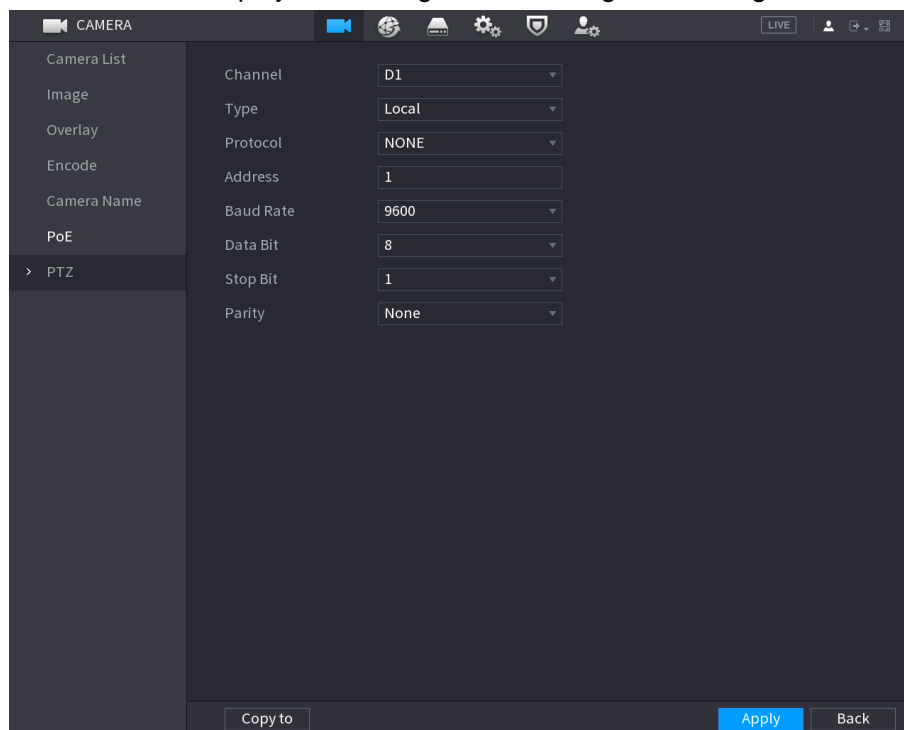
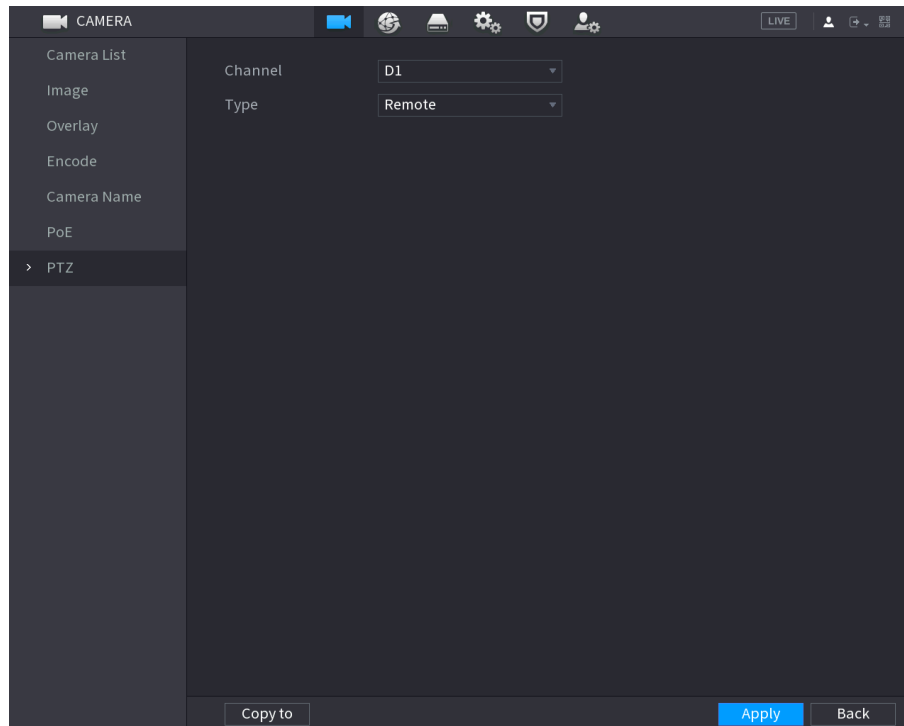



Figure 4-92



Step 2 Configure parameters. See Table 4-26.

Table 4-26

Parameter	Description
Channel	In the Channel list, select the channel that you want to connect the PTZ camera to.
Type	<ul style="list-style-type: none"> Local: Connect through RS-485 port. Remote: Connect through network by adding IP address of PTZ camera to the Device.
Protocol	In the Protocol list, select the protocol for the PTZ camera such as PELCOD.
Address	In the Address box, enter the address for PTZ camera. The default is 1.  The entered address must be the same with the address configured on the PTZ camera; otherwise the system cannot control PTZ camera.
Baud rate	In the Baud rate list, select the baud rate for the PTZ camera. The default is 9600.
Data Bit	The default value is 8.
Stop Bit	The default value is 1.
Parity	The default is value NONE.

Step 3 Click **Apply**.

4.4.2 PTZ Control

PTZ control panel performs the operations such as directing camera in eight directions,

adjusting zoom, focus and iris settings, and quick positioning.

Basic PTZ Control Panel

Right-click on the live view screen and then select PTZ. The PTZ control panel is displayed.

Figure 4-93

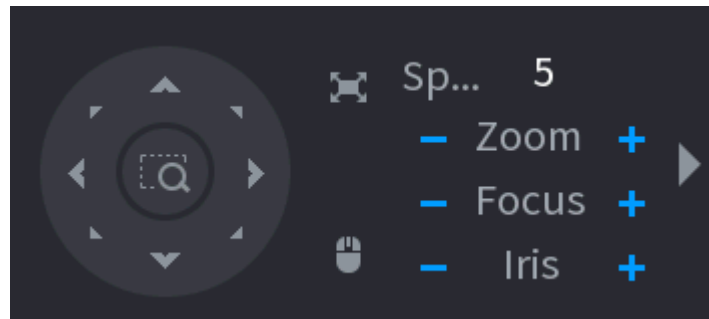

- The gray button means system does not support current function.
- For some series products, the PTZ function is valid in one-window mode.

Table 4-27

Parameter	Description
Speed	Controls the movement speed. The bigger the value is, the faster the movement will be.
Zoom	- : Zoom out. + : Zoom in.
Focus	- : Focus far. + : Focus near.
Iris	- : Image darker. + : Image brighter.
PTZ movement	Supports eight directions.
	Fast positioning button. <ul style="list-style-type: none"> • Positioning: Click to enter the fast positioning screen, and then click anywhere on the live view screen, the PTZ will turn to this point and move it to the middle of the screen. • Zooming: On the fast positioning screen, drag to draw a square on the view. The square supports zooming. • Dragging upward is to zoom out, and dragging downward is to zoom in. • The smaller the square, the larger the zoom effect. This function is for some series products only and can only be controlled through mouse operations.
	Click , you can control the four directions (left, right, up, and down) PTZ movement through mouse operation.
	Click to open the expanded PTZ control panel.

Expanded PTZ Control Panel









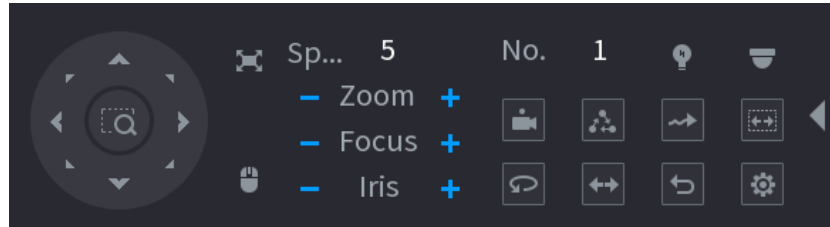

On the basic PTZ control panel, click  to open the expanded PTZ control panel to find more options. See Figure 4-94.

Figure 4-94



- The functions with buttons in gray are not supported by the system.
- Right-click once to return to the interface of PTZ basic control panel.

Icon	Function	Icon	Function
	Preset		Pan
	Tour		Flip
	Pattern		Reset
	Scan		Click the AUX Config icon to open the PTZ functions settings interface.
	AUX Switch		Click the Enter Menu icon to open the PTZ Menu interface.

4.4.3 Configuring PTZ Functions

4.4.3.1 Configuring Presets

Procedure

- Step 1** On the expanded PTZ control panel, click .
The **Preset** interface is displayed. See Figure 4-95.

Figure 4-95



- Step 2 Click the direction arrows to the required position.
- Step 3 In the **Preset** box, enter the value to represent the required position.
- Step 4 Click **Setting** to complete the preset settings.

4.4.3.2 Configuring Tours

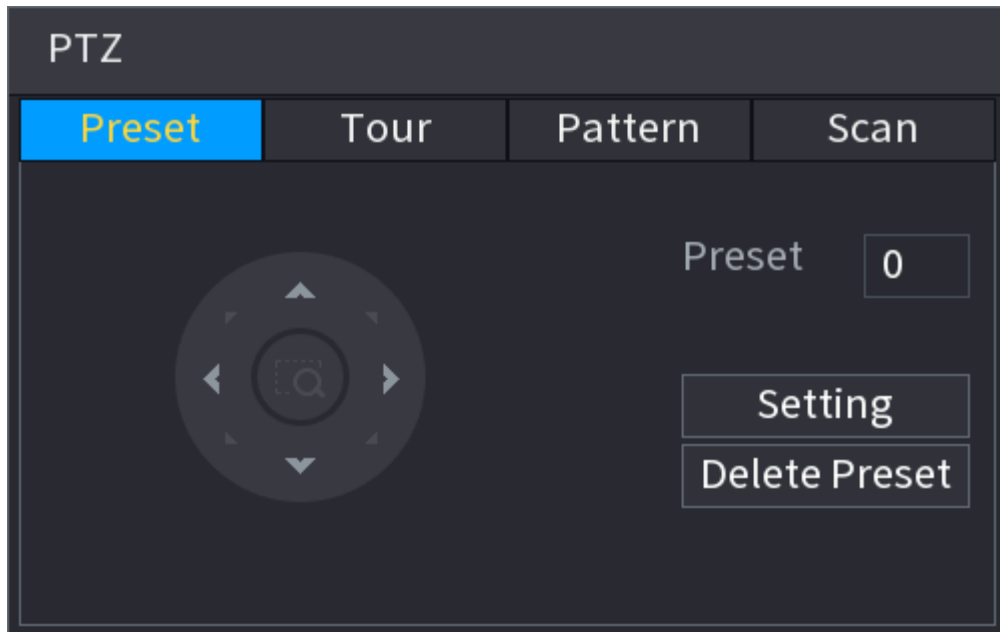
Procedure

- Step 1 On the expanded PTZ control panel, click .
The **PTZ** interface is displayed.
- Step 2 Click the **Tour** tab.
The **Tour** tab is displayed. See Figure 4-96.

Figure 4-96



- Step 3 In the **Tour No.** box, enter the value for the tour route.
- Step 4 In the **Preset** box, enter the preset value.

- Step 5 Click **Add Preset**.
A preset will be added for this tour.

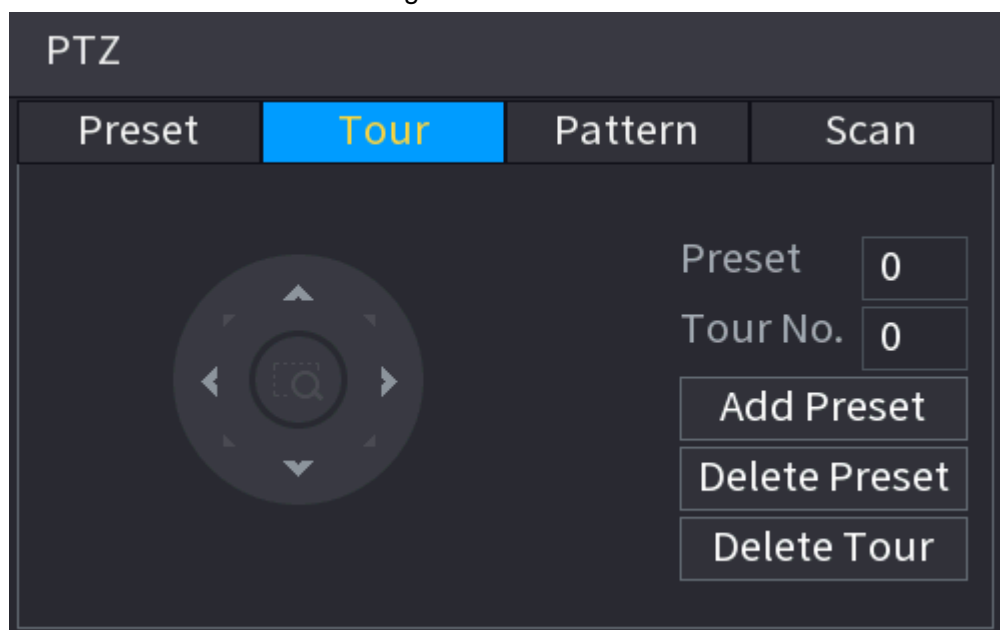

- You can repeat adding more presets.
- Click **Delete Preset** to delete the preset for this tour. This operation can be repeated to delete more presets. Some protocols do not support deleting.

4.4.3.3 Configuring Patterns

Procedure

- Step 1 On the expanded PTZ control panel, click .
The **PTZ** interface is displayed.
- Step 2 Click the **Pattern** tab.
The **Pattern** interface is displayed. See Figure 4-97.

Figure 4-97



- Step 3 In the **Pattern** box, enter the value for pattern.
- Step 4 Click **Start** to perform the directions operations. You can also go to the PTZ Control Panel to perform the operations of adjusting zoom, focus, iris, and directions.
- Step 5 On the **PTZ** interface, click **End** to complete the settings.

4.4.3.4 Configuring AutoScan

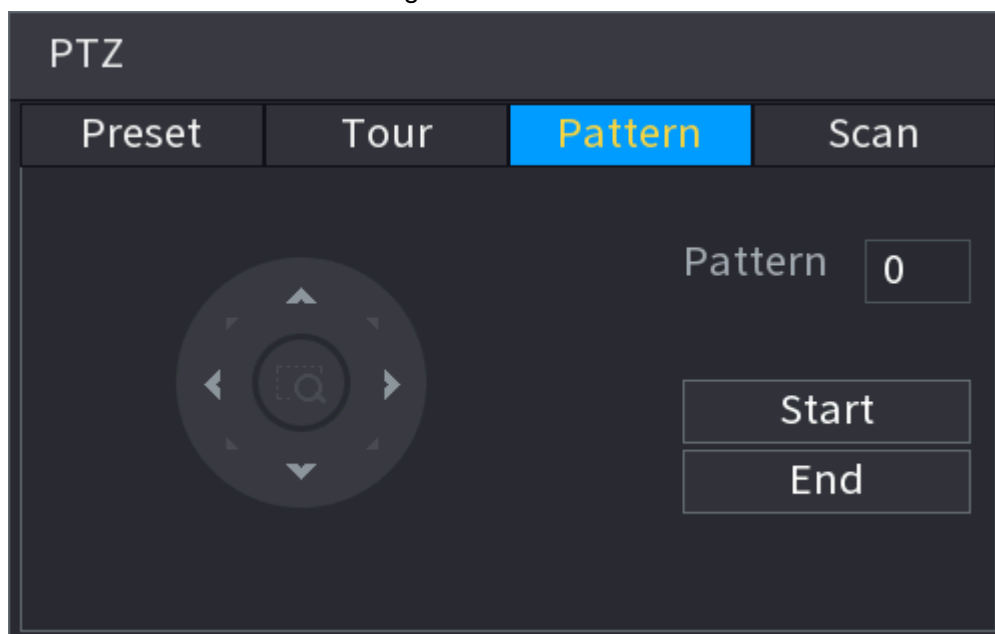
Procedure

- Step 1 On the expanded PTZ control panel, click .
The **PTZ** interface is displayed.
- Step 2 Click the **Scan** tab.
The **Scan** interface is displayed. See Figure 4-98.

Figure 4-98



Step 3 Click the direction arrows to position the left and right limits.

4.4.4 Calling PTZ Functions

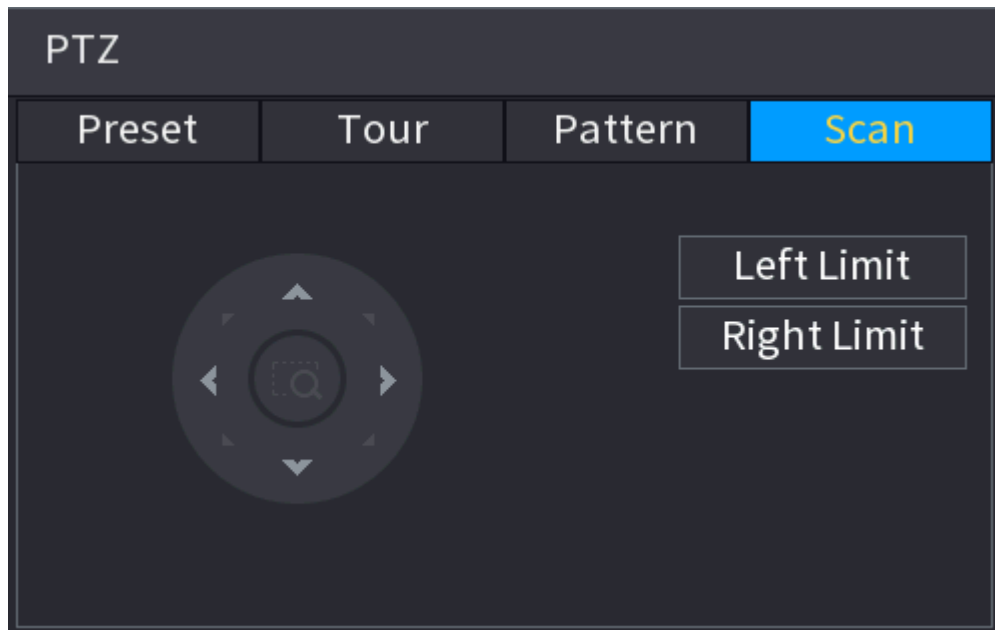
After you have configured the PTZ settings, you can call the PTZ functions for monitoring from the Expanded PTZ Control Panel. See Figure 4-99.

Figure 4-99

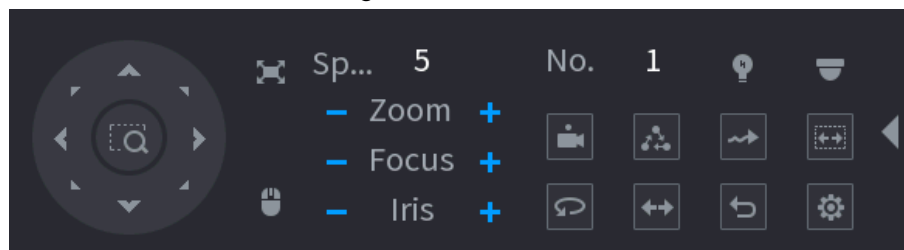

4.4.4.1 Calling Presets

Procedure

- Step 1 On the expanded PTZ control panel, in the **No.** box, enter the value of the preset that you want to call.
- Step 2 Click to call the preset.
- Step 3 Click again to stop calling the preset.

4.4.4.2 Calling Tours



Procedure

- Step 1 On the expanded PTZ control panel, in the **No.** box, enter the value of the tour that you want to call.
- Step 2 Click to call the tour.

Step 3 Click  again to stop calling the tour.



4.4.4.3 Calling Patterns

Procedure

- Step 1 On the expanded PTZ control panel, in the **No.** box, enter the value of the pattern that you want to call.
- Step 2 Call  to call the pattern.
- Step 3 The PTZ camera moves according to the configured pattern repeatedly.
- Step 4 Click  again to stop calling the pattern.



4.4.4.4 Calling AutoScan

Procedure

- Step 1 On the expanded PTZ control panel, in the **No.** box, enter the value of the border that you want to call.
- Step 2 Click .
- Step 3 The PTZ camera performs scanning according to the configured borders.
- Step 4 Click  again to stop auto scanning.

4.4.4.5 Calling AutoPan

Procedure

- Step 1 On the expanded PTZ control panel, click  to start moving in horizontal direction.
- Step 2 Click  again to stop moving.

4.4.4.6 Using Auxiliary Button

On the expanded PTZ control panel, click , the AUX setting interface is displayed. See Figure 4-99.

In the **Shortcut Aux** list, select the option that corresponds to the applied protocol.

In the **Aux No.** box, enter the number that corresponds to the AUX switch on the decoder.

Figure 4-100

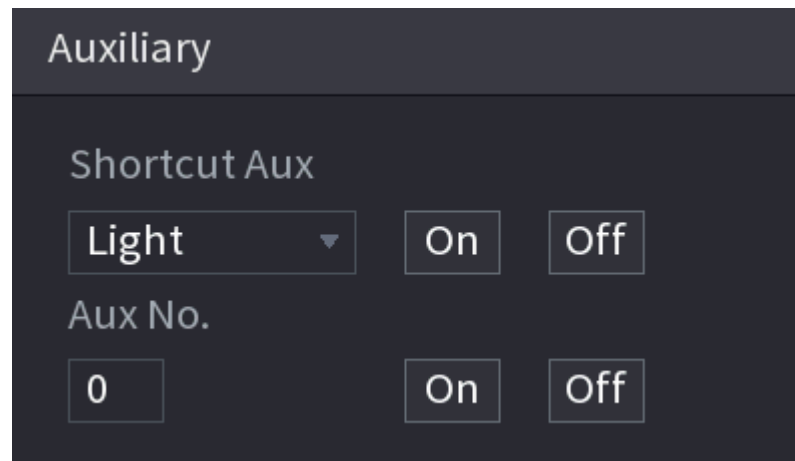

4.5 Record File

Device adopts 24-hour continuous record by default. It supports customized record period and record type. Refer to "4.1.4.6 Schedule" for detailed information.

4.6 Playback and Search

4.6.1 Instant Playback

You can view the record file of previous 5 to 60 minutes. Refer to "4.3.2 Navigation bar" for instant playback information.

4.6.2 Search Interface

You can search and playback the recorded files on the NVR.

Select **Main Menu** > **SEARCH**, or right-click on the live view interface and then select **Search**, the search and playback interface is displayed. See Figure 4-101.



The following figure is for reference only.

Figure 4-101

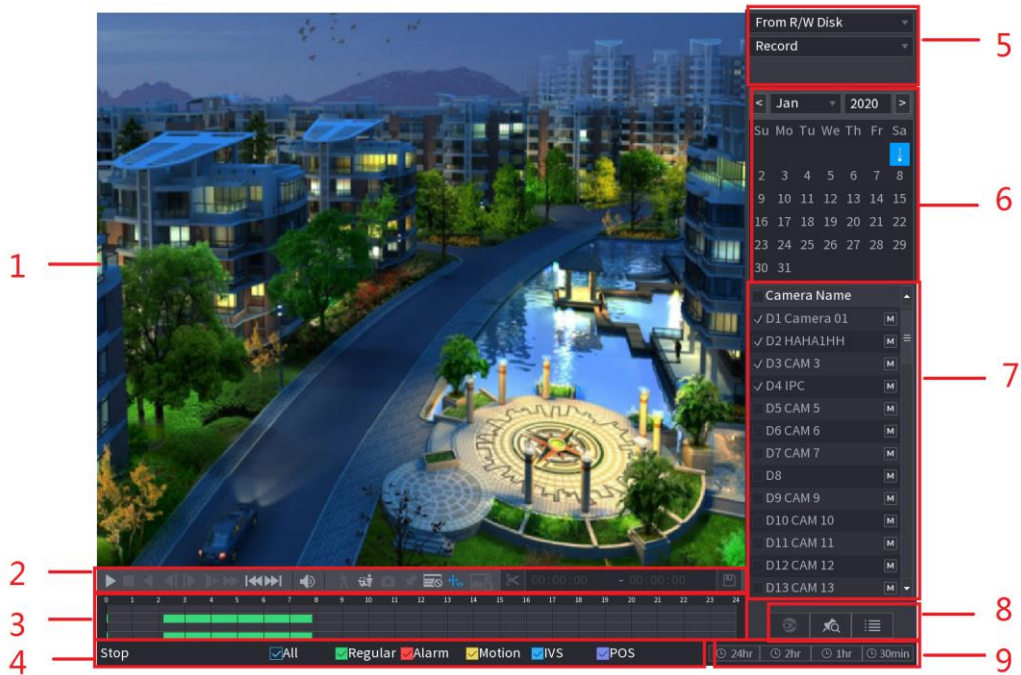









Table 4-28

No.	Function	Description
1	Display Window	<p>Display the searched recorded video or picture. It supports playing in single-channel, 4-channel, 9-channel, and 16-channel simultaneously.</p> <p></p> <p>When playing back in a single channel mode, hold down the left mouse button to select the area that you want to enlarge. The area is enlarged after the left mouse button is released. To exit the enlarged status, right-click on the image.</p>
2	Playback Controls Bar	Playback control buttons. Refer to "4.6.2.1 Playback Control" for detailed information.
	Clip	Click  to edit the record file and then save specified footages. Refer to "4.6.2.3 Clip" for detailed information.
	Backup	Click  to backup record. Refer to "4.6.2.4 Record Backup" for detailed information.

No.	Function	Description
3	Time Bar	<p>Display the type and time period of the current recorded video.</p> <ul style="list-style-type: none"> ● In the 4-channel layout, there are four time bars are displayed; in the other view layouts, only one time bar is displayed. ● Click on the colored area to start playback from a certain time. ● In the situation when you are configuring the settings, rotate the wheel button on the time bar, the time bar is zooming in from 0. In the situation when playback is ongoing, rotate the wheel button on the time bar, the time bar is zooming from the time point where the playback is located. ● Time bar colors: Green indicates general type; Red indicates external alarm; Yellow indicates motion detection; Blue indicates intelligent events; Purple indicates POS events. ● Click and hold the time bar, and the mouse pointer shall change to a hand icon, and then you can drag to view the playback of the target time. ● You can drag the vertical orange line on the time bar to rapidly view the playback in iframe format. ● When playing back video in one channel mode, you can move mouse pointer to time bar for 0.1 seconds to display thumbnail pictures for the video of selected. Four pictures before and four pictures after the selected time, and the thumbnail picture of the selected time will be displayed. ● For some models, when you are clicking on the blank area in the time bar, the system automatically jumps to the next time point where there is a recorded video located.
4	Play Status	Includes two playback status: Play and Stop .
	Record type	Select the check box to define the recording type to search for.
5	Search type	Select the content to play back: Record , Picture , Subperiod . For details about the selecting search type, refer to "4.6.2.2 Search Type" for detailed information.
6	Calendar	<p>Click the date that you want to search, the time bar displays the corresponding record.</p> <p>The dates with record or snapshot have a small solid circle under the date.</p>

No.	Function	Description
7	View Layout and Channel Selection	<ul style="list-style-type: none"> In the Camera Name list, select the channel(s) that you want to play back. The window split is decided by how you select the channel(s). For example, if you select one channel, the playback is displayed in the single-channel view; if you select two to four channels, the playback is displayed in the four-channel view. The maximum is eight channels. Click M to switch the streams. M indicates main stream, and S indicates sub stream.
8	List Display	<p>This area includes Tag List and File List.</p>  <p>Different series products have different functions. The icons displayed may vary. The actual product shall prevail.</p> <ul style="list-style-type: none"> : Click Tag List, the marked recorded video list is displayed. Double-click the file to start playing. : Click File List, the searched recorded video list is displayed. You can lock/unlock the files. Refer to "4.6.8 File List" for detailed information. : Fisheye dewarp. It is to display the dewarp fisheye video. Refer to "4.3.6.2 Fisheye De-warp During Playback" for detailed information.
14	Time Bar Unit	You can select 24hr, 2hr, 1hr, or 30min as the unit of time bar. The time bar display changes with the setting.



All the operations here (such as playback speed, channel, time and progress) have relationship with hardware version. Some series NVRs do not support some functions or playback speeds.

4.6.2.1 Playback Control



The playback control interface is shown as below. See Figure 4-102.

















Figure 4-102





Refer to the following sheet for more information. See Table 4-29.

Table 4-29

Icon	Function
	Play/Pause In slow play mode, click it to switch between play/pause.
	Stop When playing back, click to stop current playback process.

Icon	Function
	<p>Backward play</p> <p>In normal play mode, left click the button, the file begins backward play. Click it again to pause current play.</p> <p>In backward play mode, click  or  to restore normal play.</p>
	<p>Display previous frame/next frame.</p> <p>When pause the normal playback file, click  or  to playback frame by frame.</p> <p>In frame by frame playback mode, click  or  to resume normal playback mode.</p>
	<p>Slow play</p> <p>In playback mode, click it to realize various slow play modes such as slow play 1, slow play 2, and etc.</p>
	<p>Fast forward</p> <p>In playback mode, click to realize various fast play modes such as fast play 1, fast play 2 and etc.</p>
	<p>Adjust the volume of the playback.</p>
	<p>Smart search .</p> <p>Refer to "4.6.3 Smart Search Playback" for detailed information.</p>
	<p>Smart motion detection. You can click the icon to select a human or motor vehicle, and the system plays detected videos of the person or motor vehicle.</p> <p></p> <p>human and motor vehicle can be selected at the same time.</p>
	<p>Click the snapshot button in the full-screen mode, the system can snapshot 1 picture.</p> <p>System supports custom snap picture saved path. Connect the peripheral device first, click snap button on the full-screen mode, you can select or create path. Click Start button, the snapshot picture can be saved to the specified path.</p>
	<p>Mark button.</p> <p>This function is for some series product only. Make sure there is a mark button in the playback control pane.</p> <p>Refer to "4.6.5 Tag Playback" for detailed information.</p>
	<p>Display/hide POS information.</p> <p>In 1-channel playback mode, you can click it to display/hide POS information on the video.</p>

Icon	Function
	In 1-channel playback mode, click it to enable/disable display IVS rule information on the video.  This function is for some series only.
	Picture search. For details, see "4.6.4 Picture Search Playback"

4.6.2.2 Search Type

You can search the recorded videos, splice, or snapshots from Disk or external storage device.

- From R/W Disk: Recorded videos or snapshots playback from HDD of the Device. See Figure 4-103.

Figure 4-103

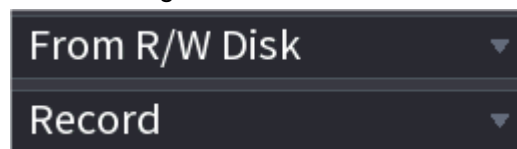

- From I/O Device: Recorded videos playback from external storage device. See Figure 4-104.

Click **Browse**, select the save path of recorded video file that you want to play.

Double-click the video file or click  to start playing.

Figure 4-104



4.6.2.3 Clip

Background Information

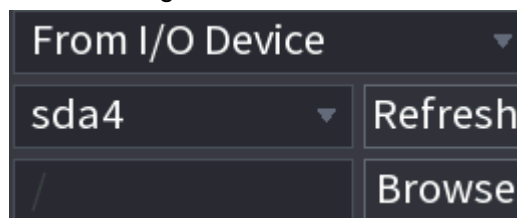
This function allows you to clip some footages to a new file and then save it to the USB device. See Figure 4-105. Follow the steps listed below.



- Clip function is for one-channel/multiple-channel.
- Max save 1024 files at the same time.
- This function is not for the file already checked in the file list.

Procedure

Step 1 Select a record first and then click  to playback.

Step 2 Select a time at the time bar and then click  to start clip.

Step 3 Select a time at the time bar and then click  to stop clip.

Step 4 Click , system pops up dialogue box to save the clip file.

Figure 4-105

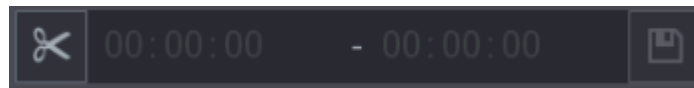

4.6.2.4 Record Backup

Background Information

This function is to backup files you checked in the file list, or the file you just clip.

Procedure



- Step 1** Select the recorded video file that you want to back up. You can select the following two types of files:
- Recorded video file: Click , the File List area is displayed. Select the file(s) that you want to back up.
 - Saves the clip footages as a record file.
- Step 2** Click , the BACKUP interface is displayed. See Figure 4-106.

Figure 4-106



Step 3 Click **Backup** to begin the process.

4.6.3 Smart Search Playback

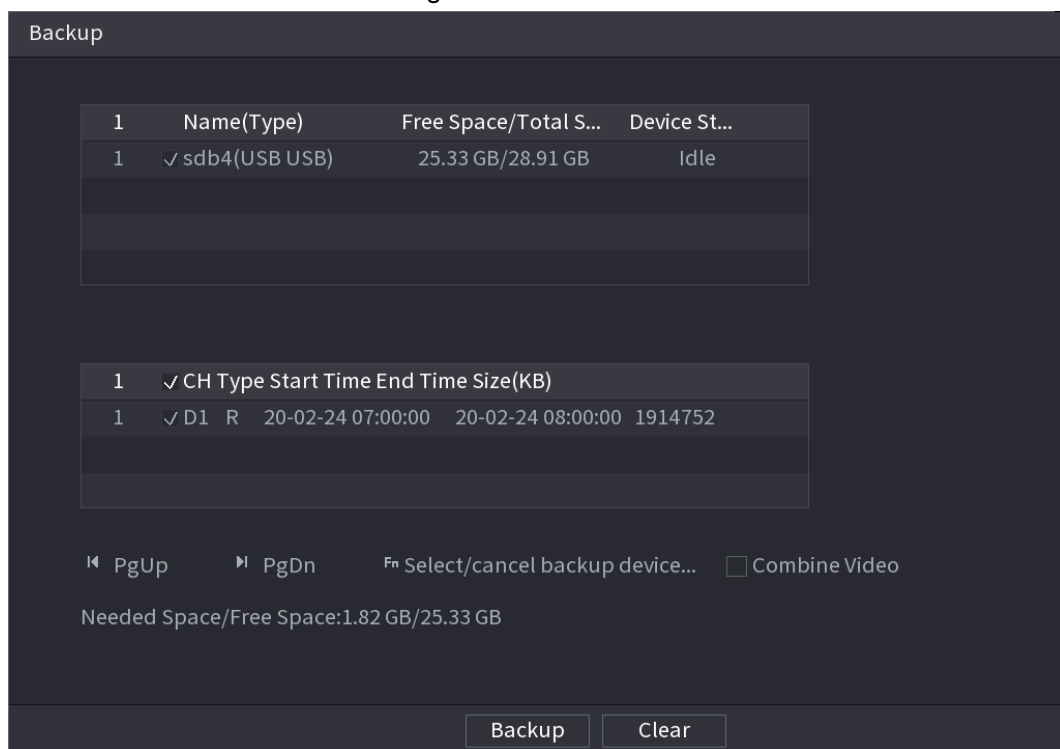
Background Information



This function is for some series product only.

During playback process, it can analyze the motion detect zone in the scene and give the

analysis result.

This function is for channel that already enabled motion detect function (**Main Menu > ALARM > Video Detection > Motion Detection**).

Procedure

Step 1 Select a channel to playback video and then click . You can view the grids on the playback video.



- This function is for one-channel playback mode.
- If you are in multiple-channel playback mode, double-click a channel first to switch to one-channel playback mode.

Step 2 Left click mouse and then drag to select smart search zones(22*18(PAL), 22*15(NTSC)).

Step 3 Click  to go to smart search and playback. System is going to playback all motion detect record footages.

Step 4 Click  again to stop smart search function.



- The motion detect region cannot be the full screen zone.
- The motion detect region adopts the current whole play pane by default.
- Selects the other file on the list, system begins playing the motion detect footages of other file.
- The time bar unit switch, backward play, frame by frame are null when system is playing motion detect file.

4.6.4 Picture Search Playback

Select the image of target person on the playback interface and then search by image for all the related videos with the target person.

Right-click on the live view interface and then select **Search** to show the search interface.

Select a channel to play back video and then click  to freeze the playback.

For more details, see "4.3.3.8 Picture Search".

Figure 4-107 Picture search playback

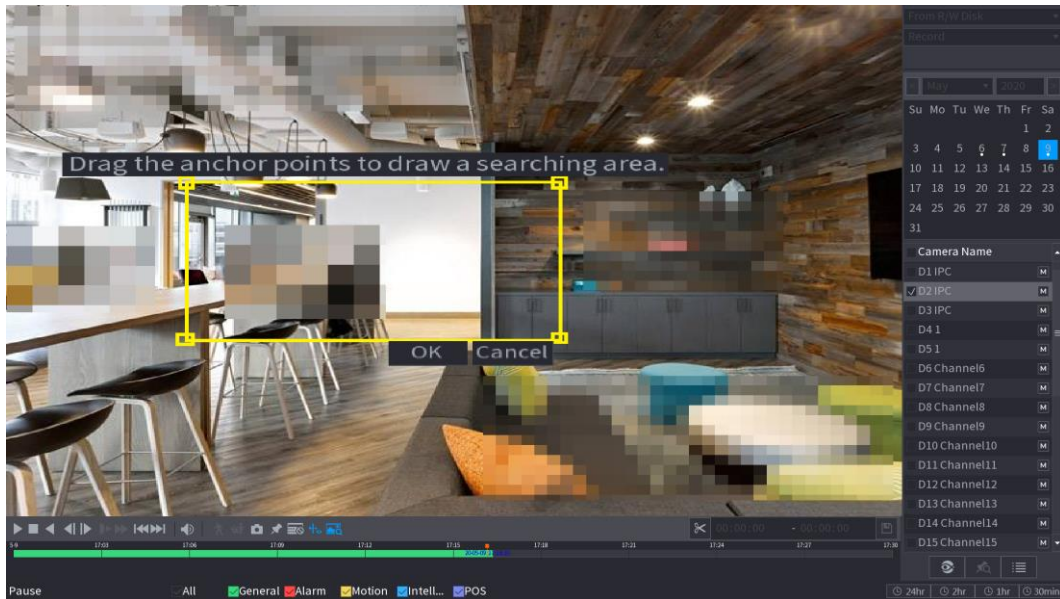

4.6.5 Tag Playback

When you are playing back a video record, you can tag the record as needed. After playback, you can use time or the tag keywords to search corresponding record and then play. It is very easy for you to get the important video information.

Add Tag



When system is playing back, click , you can go to the following interface. See Figure 4-108.

Figure 4-108

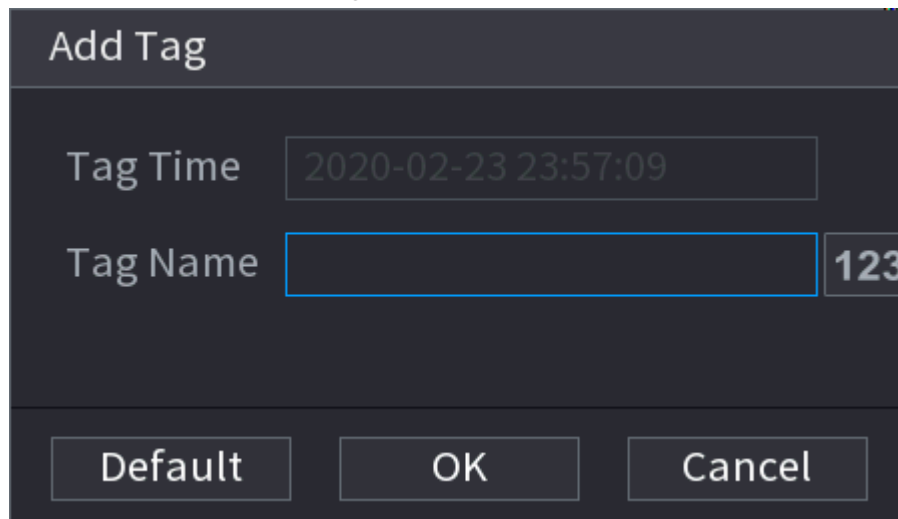

Play back Tag

During 1-window playback mode, click , you can go to tag file list interface. Double-click one tag file, you can begin playback from the tag time.

Play before tag time

Here you can set to begin playback from previous N seconds of the tag time.



Usually, system can play back previous N seconds record if there is such kind of record file. Otherwise, system playbacks from the previous X seconds when there is such as kind of record.

Tag Manager

Click the mark manager button  on the Search interface (Figure 492); you can go to Manager interface. See Figure 4-109. System can manage all the record mark information of current channel by default. You can view all mark information of current channel by time.

Figure 4-109



	Channel	Start Time	End Time	Search
	5	2017 - 11 - 08 00 : 00 : 00	2017 - 11 - 09 00 : 00 : 00	Search
2	CH	Mark Time	Name	
1	5	2017-11-08 03:19:30	123	
2	5	2017-11-08 10:30:34	456	

Buttons: Delete, Cancel

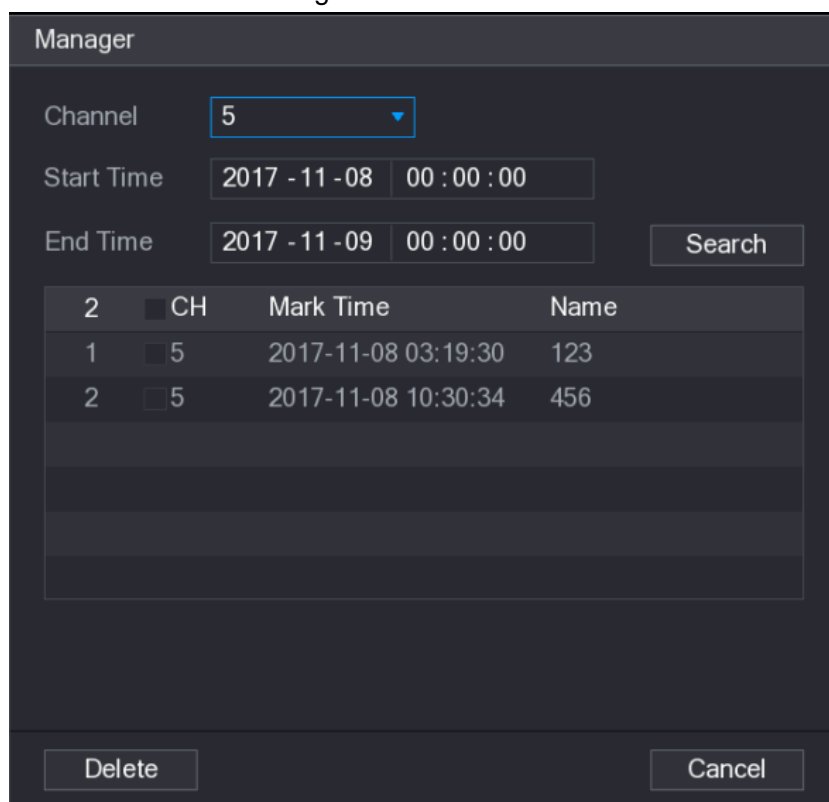
Modify

Double-click one tag information item, you can see system pops up a dialogue box for you to change tag information. You can only change tag name here.

Delete

Here you can check the tag information item you want to delete and then click **Delete**, you can remove one tag item.



- After you go to the tag management interface, system needs to pause current playback. System resume playback after you exit tag management interface.
- If the tag file you want to playback has been removed, system begins playback from the first file in the list.

4.6.6 Playback Image

Background Information

Here you can search and play the image. Follow the steps listed below.

Procedure

- Step 1 Select **Main Menu > Search**, or right-click on the live view window and select **Search**, you can go to the **Search** interface.
- Step 2 At the upper-right corner, select image and then input playback interval.
- Step 3 Select date and channel, click  to play.

4.6.7 Subperiod Playback

Background Information

You can clip the recorded video files into splices and then play back at the same time to save your time.



This function is for some series products only.

Procedure

- Step 1 Select **Main Menu > SEARCH**.
The **SEARCH** interface is displayed.
- Step 2 In the Search Type list, select **Subperiod**; In the Split Mode list, select 4, 8, or 16.
See Figure 4-110.

Figure 4-110

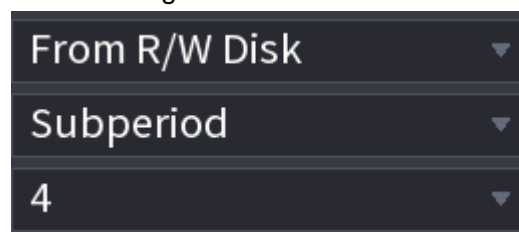

- Step 3 In the **Calendar** area, select a date.
- Step 4 In the **Camera Name** list, select a channel.



Only single-channel supports this function.

- Step 5 Start playing back splices. See Figure 4-111.
Click , the playback starts from the beginning.
Double-click anywhere on the time bar, the playback starts from where you click.

Figure 4-111



4.6.8 File List





Click , system displays file list. It displays the first channel of the record. See Figure 4-112.

Figure 4-112

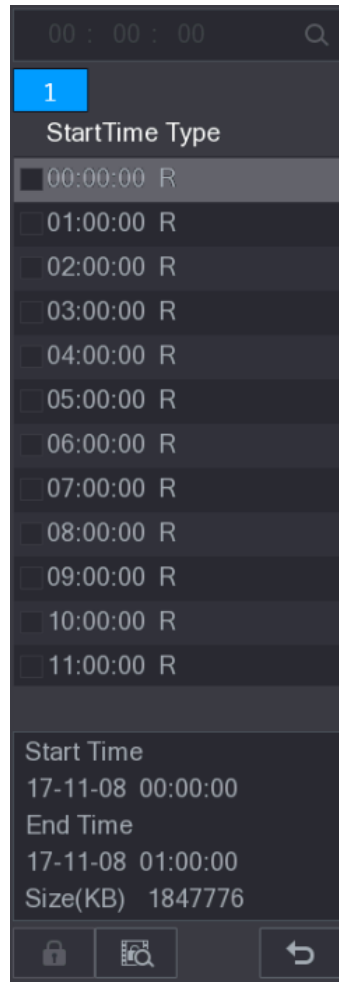

- Check a file name, double-click the file or click  to play.
- Input accurate time at the top column, you can search records of current day.
- System max displays 128 record files in one list.
- Click  to go back to the calendar/channel selection interface.

Lock or Unlock File

- To lock the recorded video, on the **File List** interface, select the check box of the recorded video, and then click . The locked video will not be overwritten.
- To view the locked information, click , the **File Lock** interface is displayed.



The recorded video that is under writing or overwriting cannot be locked.

- To unlock the recorded video, in the **File Lock** interface, select the video, and then click **Unlock**. See Figure 4-113.

Figure 4-113

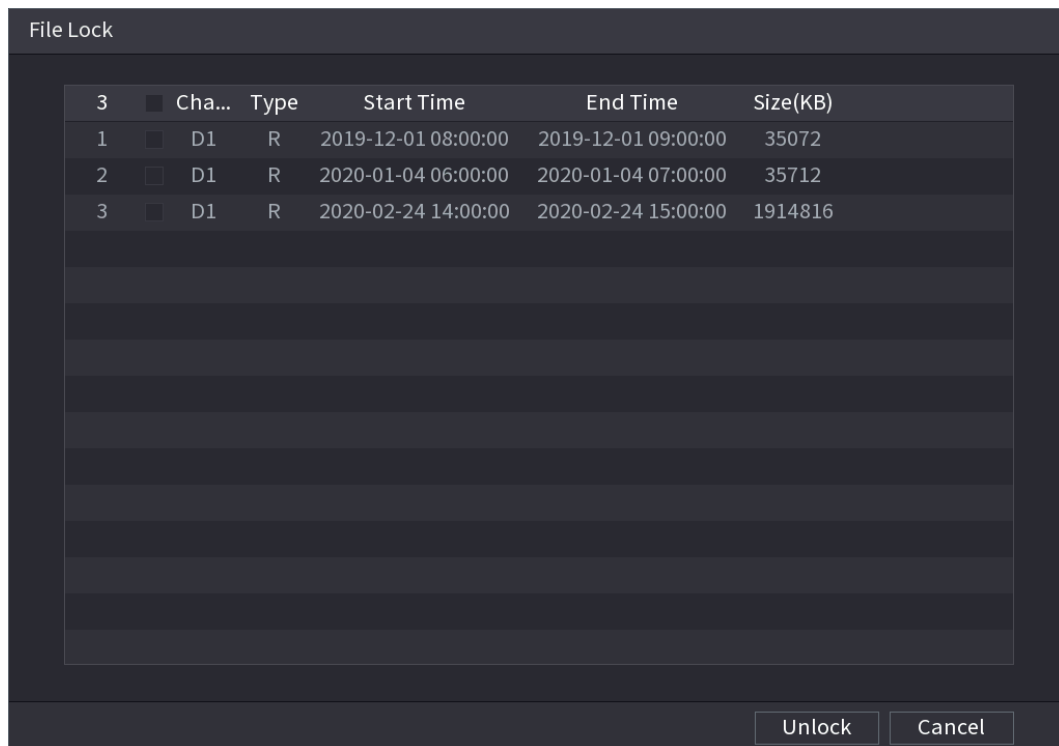

	Cha...	Type	Start Time	End Time	Size(KB)
1	D1	R	2019-12-01 08:00:00	2019-12-01 09:00:00	35072
2	D1	R	2020-01-04 06:00:00	2020-01-04 07:00:00	35712
3	D1	R	2020-02-24 14:00:00	2020-02-24 15:00:00	1914816

4.6.9 Other Aux Functions

4.6.9.1 Digital Zoom

In 1-window playback mode, left click mouse to select any zone on the screen, you can zoom in current zone. Right click mouse to exit.

4.6.9.2 Switch Channel

- During playback mode, select from the drop-down list to switch playback channel.
- The smart search channel does not support this function either.
- When system is playing back the record file, click the number button at the front panel, system begins playing the record file of selected channel dated the same time.

4.7 AI

4.7.1 AI Search

You can search the record file on the NVR and filter the record file meets the corresponding rule. It is suitable for you to play the specified file.



This series NVR products support playback the AI by camera file only. AI by camera means the connected camera does all the AI analytics, and then gives the results to the NVR.

4.7.1.1 Face Detection

Background Information

You can search the detected faces and play back recordings.

Procedure

- Step 1** Select **Main Menu > AI > AI Search > Face Detection**.
The **Face Detection** interface is displayed. See Figure 4-114.

Figure 4-114

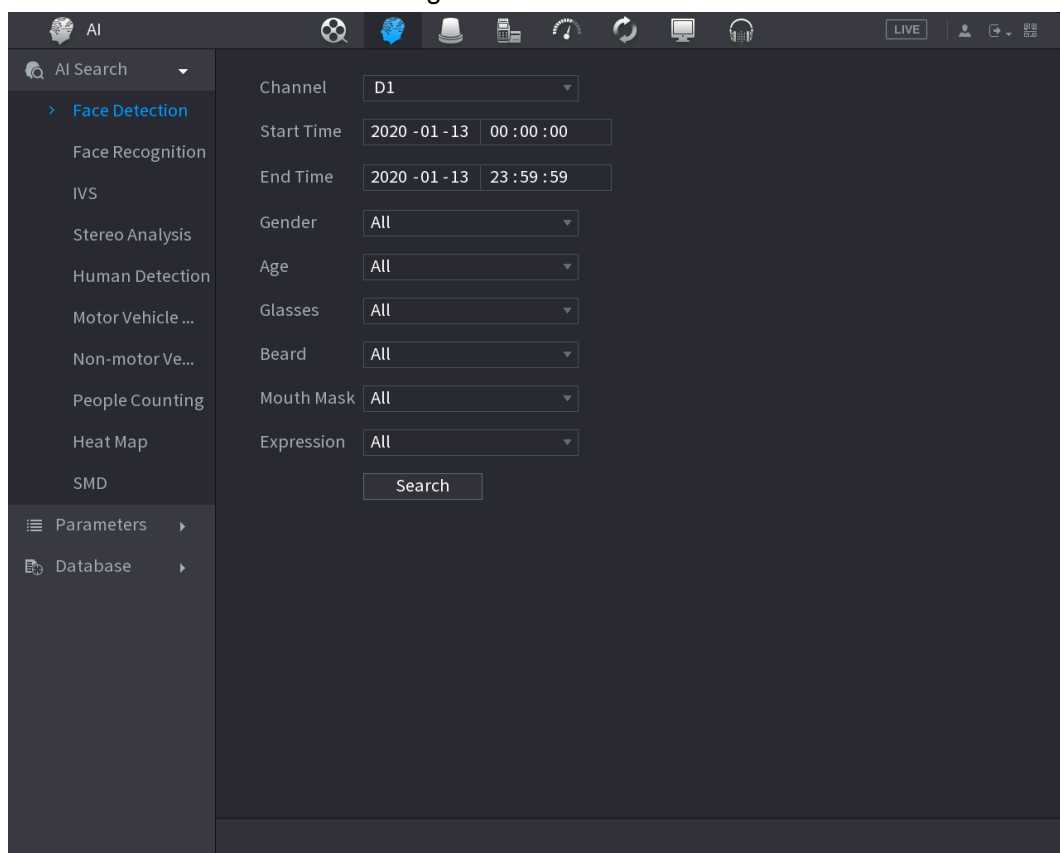

- Step 2** Select the channel, enter the start time and end time, and set for the gender, age, glasses, beard, and mask. Click **Search**. The results are displayed. See Figure 4-115.



For privacy reason, the human face in the image is pixelated. The actual image is clear.

Figure 4-115

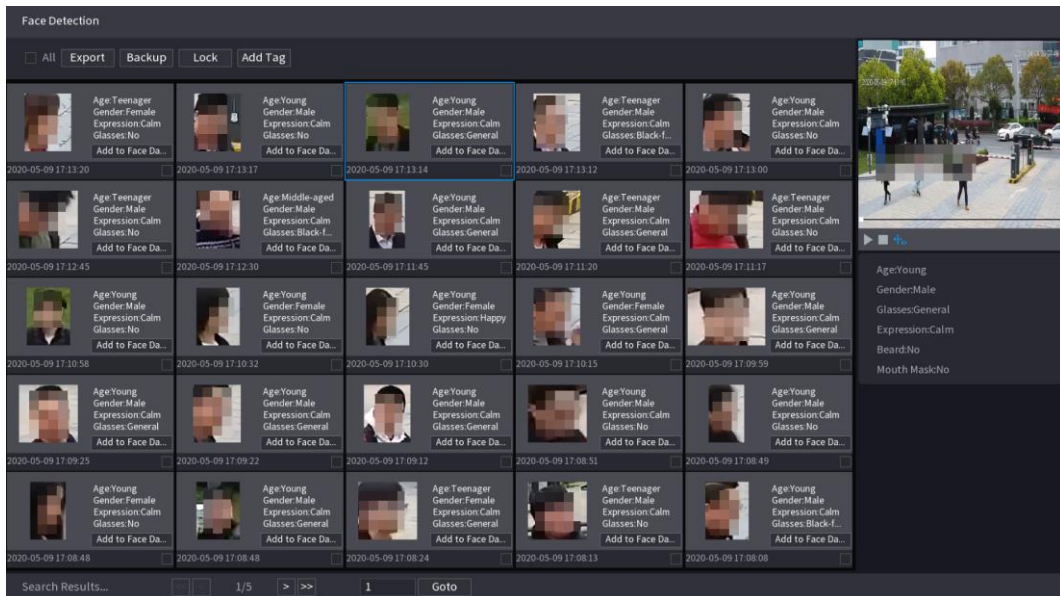

Step 3 Select the face that you want to play back.

The picture with registered information is displayed.

You can also do the following operations to the recorded files.

- Click **Export** to export results in Excel format.
- To back up the recorded files to the external storage device, select files, click **Backup**, select the save path and file type, and then click **Start**. See Figure 4-116.

Figure 4-116

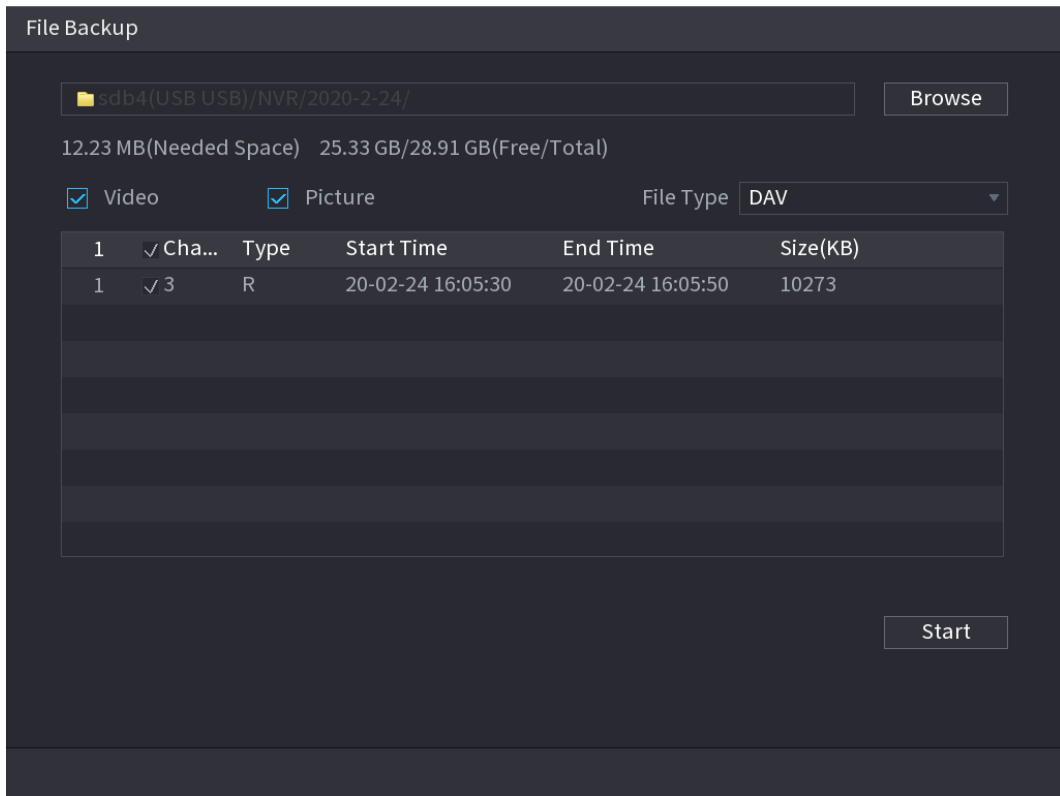

- To lock the files to make it unable to be overwritten, select the files, and then click **Lock**.
- To add a tag to the file, select the files and then click **Add Tag**.
- Click **Add to Face Database** and enter corresponding information in the displayed interface, and then add the picture to the face database.

Figure 4-117 Add face pictures to database

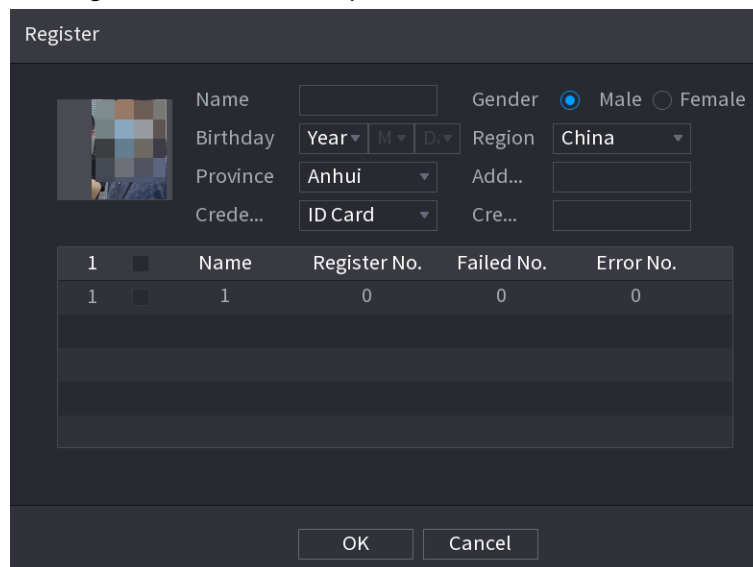

4.7.1.2 Face Recognition

System can search and compare the human face on the video with the face image on the

database, and playback the corresponding record file.

The AI search includes two ways: Search by attributes and search by image.



This function is for some series products only.

4.7.1.2.1 Searching by Attributes

Procedure

- Step 1** Select **Main Menu > AI > AI Search > Face Recognition > Search by Attributes**. The **Search by Attributes** interface is displayed. See Figure 4-118.

Figure 4-118

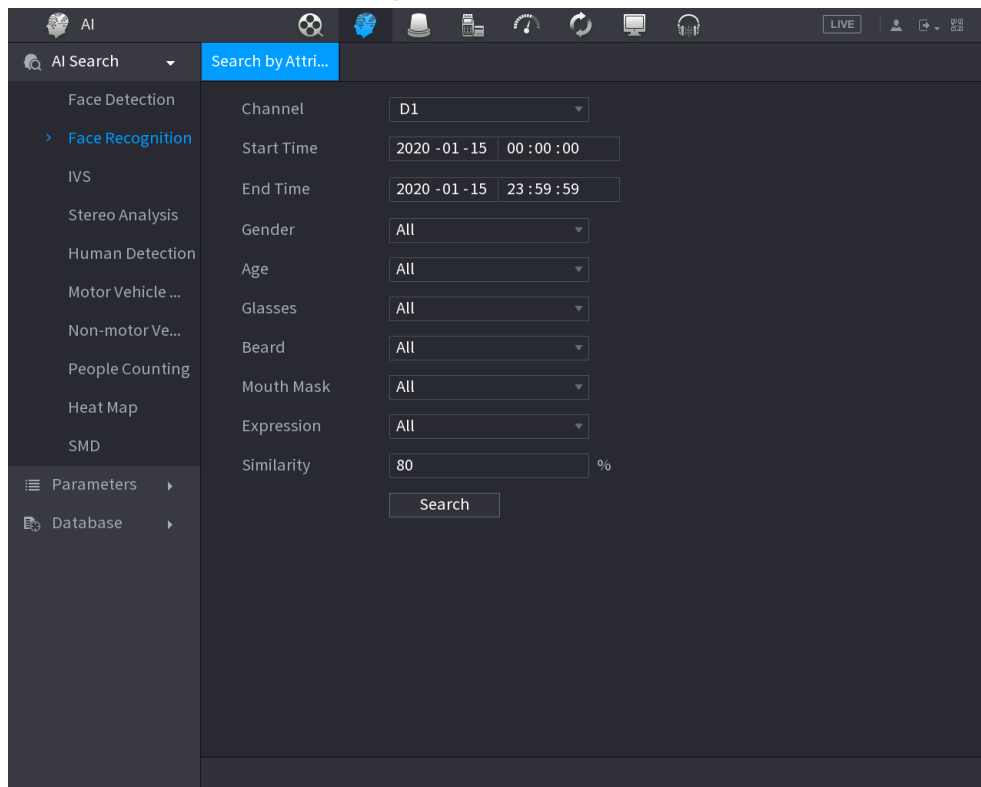

- Step 2** Select the channel and set the parameters such as start time, end time, gender, age, glasses, beard, mask, and similarity according to your requirement.

- Step 3** Click **Search**.

The search result is displayed. See Figure 4-119.



The human face in the image is pixelated. The actual image is clear.

Figure 4-119

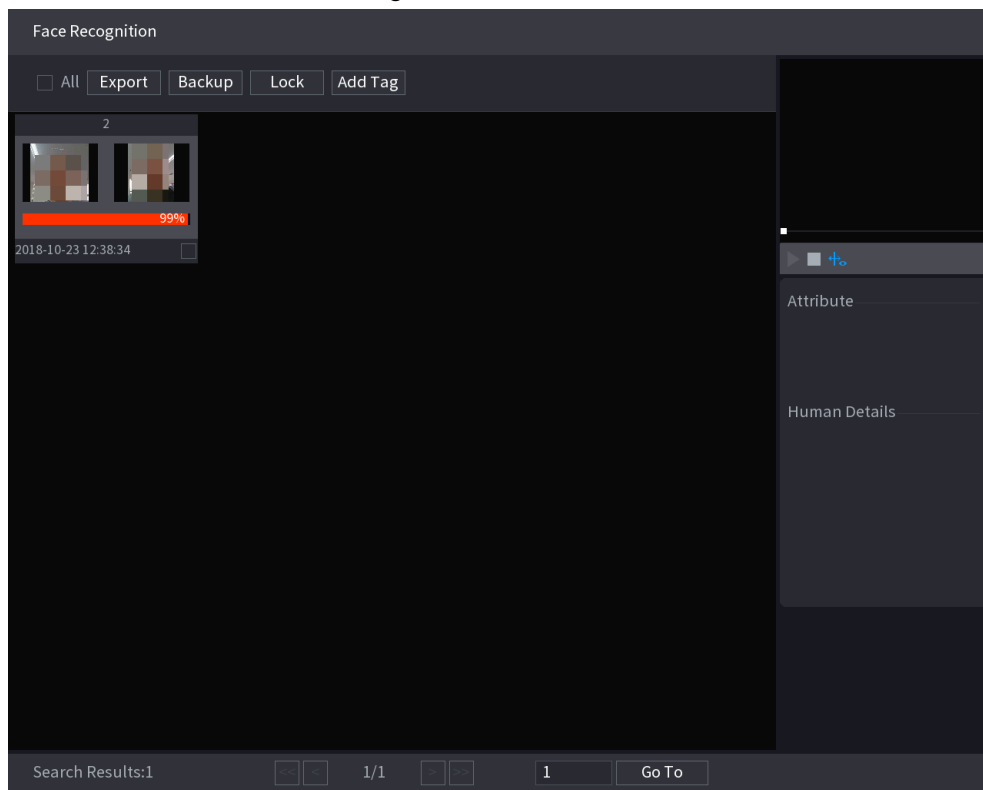

Step 4 Click the picture that you want to play back.

The picture with registered information is displayed.

You can also do the following operations to the recorded files.

- To back up the recorded files to the external storage device, select files, click **Backup**, select the save path and file type, and then click **Start**.
- To lock the files to make it unable to be overwritten, select the files, and then click **Lock**.
- To add a mark to the file, select the files and then click **Add Tag**.
- Go to the **Attributes** and **Human Details** to view detailed information.

4.7.1.2.2 Search by Image

Step 1 Select **Main Menu > AI > AI Search > Face Recognition > Search by Image**.

The **Search by Image** interface is displayed. See Figure 4-120.

Figure 4-120

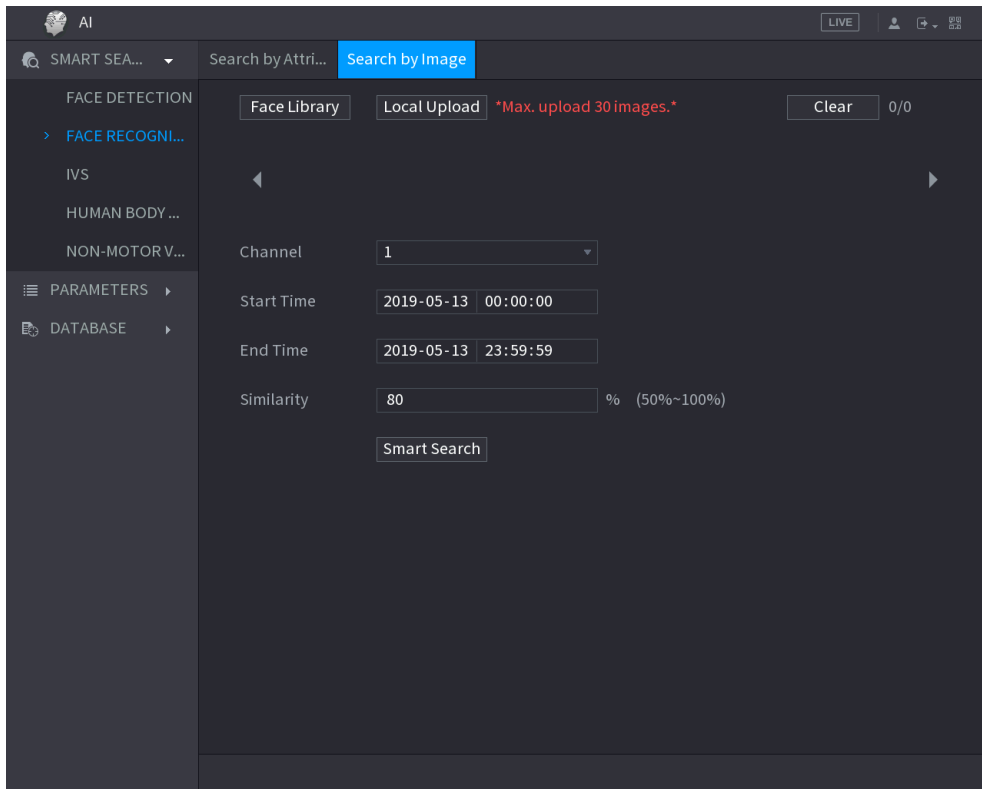

Step 2 Select the channel and set the parameters such as start time, end time, gender, age, glasses, beard, mask, and similarity according to your requirement.

Step 3 Click **Search**.

The search result is displayed. See Figure 4-121.



The human face in the image is pixelated. The actual image is clear.

Figure 4-121

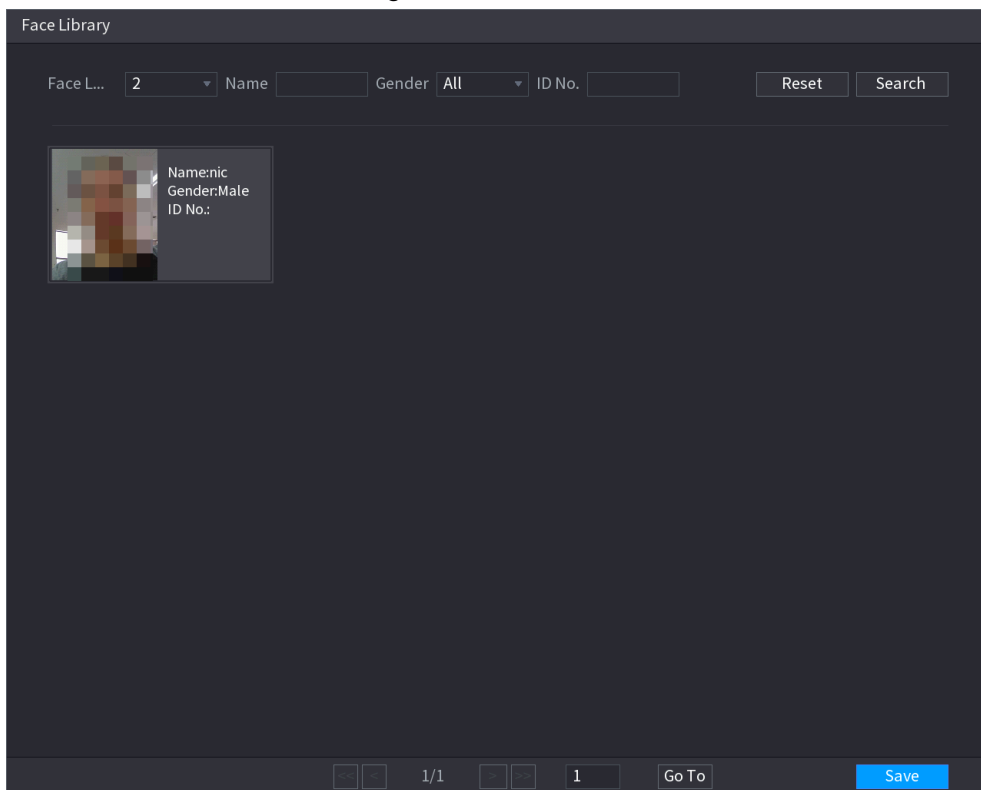

- Step 4** Click the picture that you want to play back.
The picture with registered information is displayed.
You can also do the following operations to the recorded files.
- To back up the recorded files to the external storage device, select files, click **Backup**, select the save path and file type, and then click **Start**.
 - To lock the files to make it unable to be overwritten, select the files, and then click **Lock**.
 - To add a mark to the file, select the files and then click **Add Tag**.
 - Go to the **Face Properties** and **Person Details** to view detailed information.

4.7.1.3 IVS

Background Information

You can search and playback the alarm record files.

Procedure

- Step 1** Select **Main Menu > AI > AI Search > IVS**.
The **IVS** interface is displayed. See Figure 4-122.

Figure 4-122

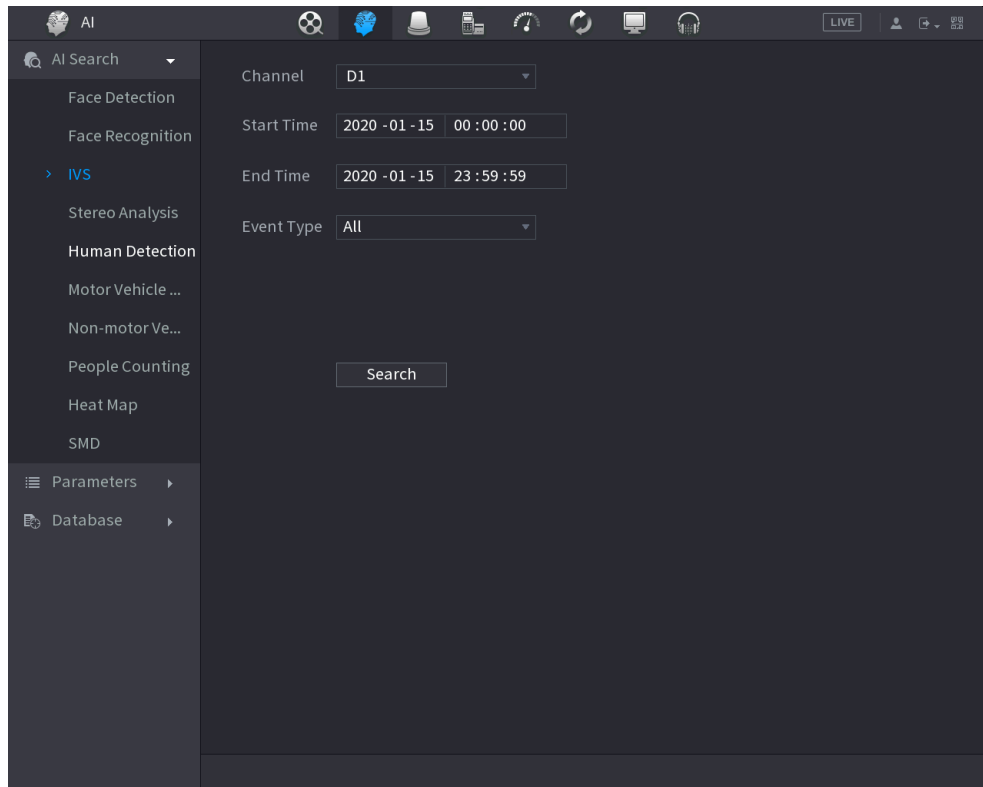

Step 2 Select a channel, start time, end time, event type, and then click **Search**.
The search result is displayed.

Step 3 Click the picture that you want to play back.

You can also do the following operations to the recorded files.

- To back up the recorded files to the external storage device, select files, click **Backup**, select the save path and file type, and then click **Start**.
- To lock the files to make it unable to be overwritten, select the files, and then click **Lock**.
- To add a mark to the file, select the files and then click **Add Tag**.
- Go to the **Attributes** and **Human Details** to view detailed information.

4.7.1.4 Stereo Analysis

By drawing and setting the rules of stereo behavior analysis, the system will perform an alarm linkage action when the video matches the detection rule. Types of events include: Human approaching detection, fall detection, severe exercise detection, number of abnormal detection and personnel retention detection.



- This feature requires access to a camera support stereo behavior analysis.
- Stereo analysis and IVS are mutually exclusive, and you need to apply smart plan in advance.

4.7.1.4.1 People Approach Detection

When two people stays in the same detection area for a minimum duration or when the distance between two people reaches the parameter setting, an alarm will be triggered.

Procedure

- Step 1 Select **Main Menu > AI > Parameters > Stereo Analysis**.
- Step 2 Select a channel and click **Add**.
- Step 3 Select **Enable** and set **Type** to **People Approach Detection**.
- Step 4 Click , and then click and hold left mouse key to draw an area on the screen.
- Step 5 Configure parameters.

Table 4-30

Parameter	Description
Sensitivity	Set alarm sensitivity.
Duration	Set the minimum time of triggering an alarm when people approach.
Repeat Alarm Time	Set repeat alarm time. If the alarm status continues, an alarm will be trigger again when repeat alarm time is reached.
Interval Threshold	When the interval between people in the area is greater than or less than the set interval threshold, an alarm will be triggered.

- Step 6 Click **OK**.

4.7.1.4.2 Fall Detection

When someone falls from a height in the detection area and the duration of the action is greater than the minimum duration set by the parameter, an alarm will be triggered.

Procedure

- Step 1 Select **Main Menu > AI > Parameters > Stereo Analysis**.
- Step 2 Select a channel and click **Add**.
- Step 3 Select **Enable** and set **Type** to **Fall Detection**.
- Step 4 Click , and then click and hold left mouse key to draw an area on the screen.
- Step 5 Configure parameters.

Table 4-31

Parameter	Description
Sensitivity	Set alarm sensitivity.
Duration	Set the minimum time of triggering an alarm when people fall.
Repeat Alarm Time	Set repeat alarm time. If the alarm status continues, an alarm will be trigger again when repeat alarm time is reached.

Step 6 Click **OK**.

4.7.1.4.3 People Exception Detection

When the number of people and alarm type are reached in the same detection area, an alarm will be triggered.

Procedure

Step 1 Select **Main Menu > AI > Parameters > Stereo Analysis**.

Step 2 Select a channel and click **Add**.

Step 3 Select **Enable** and set **Type** to **People Exception Detection**.

Step 4 Click , and then click and hold left mouse key to draw an area on the screen.

Step 5 Configure parameters.

Table 4-32

Parameter	Description
Sensitivity	Set alarm sensitivity.
Duration	Set the minimum time of triggering an alarm when the number of people reaches threshold.
Repeat Alarm Time	Set repeat alarm time. If the alarm status continues, an alarm will be trigger again when repeat alarm time is reached.
Alarm People No.	When the interval between people in the area is greater than or equal to or less than the set interval threshold, an alarm will be triggered.

Step 6 Click **OK**.

4.7.1.4.4 People Retention Detection

When the target stays beyond the set retention time threshold in the detection area, an alarm will be triggered.

Step 1 Select **Main Menu > AI > Parameters > Stereo Analysis**.

Step 2 Select a channel and click **Add**.

Step 3 Select **Enable** and set **Type** to **People Retention Detection**.

Step 4 Click , and then click and hold left mouse key to draw an area on the screen.

Step 5 Configure parameters.

Table 4-33

Parameter	Description
Sensitivity	Set alarm sensitivity.

Parameter	Description
Duration	Set the minimum time of triggering an alarm when people stay in the detection area.
Repeat Alarm Time	Set repeat alarm time. If the alarm status continues, an alarm will be trigger again when repeat alarm time is reached.
Alarm People No.	When the interval between people in the area is greater than or equal to or less than the set interval threshold, an alarm will be triggered.

Step 6 Click **OK**.

4.7.1.5 Human Detection

Background Information

You can search the human body in videos and search the alarm record during the specified period.

Procedure

- Step 1 Select **Main Menu > AI > AI Search > Human Detection**.
The **Human Detection** interface is displayed. See Figure 4-123.

Figure 4-123

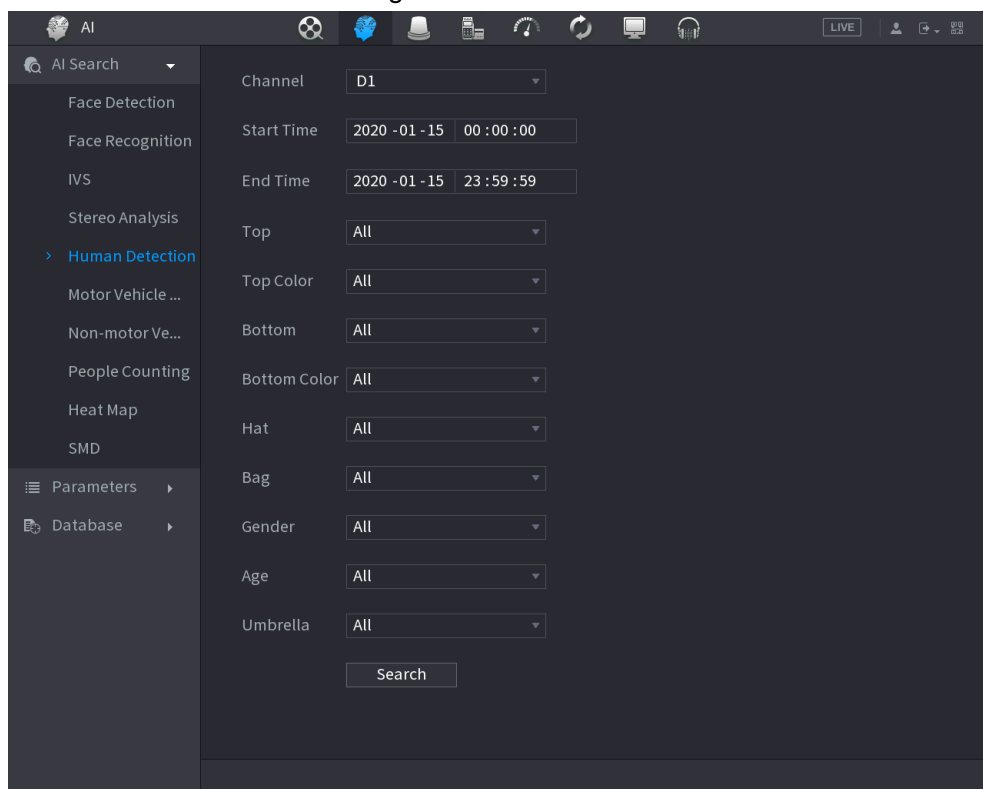

Step 2 Select a channel, start time, end time, and set corresponding parameters.

Step 3 Click **Search**.

The search result is displayed. See Figure 4-124.



For privacy reason, the human face in the image is pixelated.

Figure 4-124

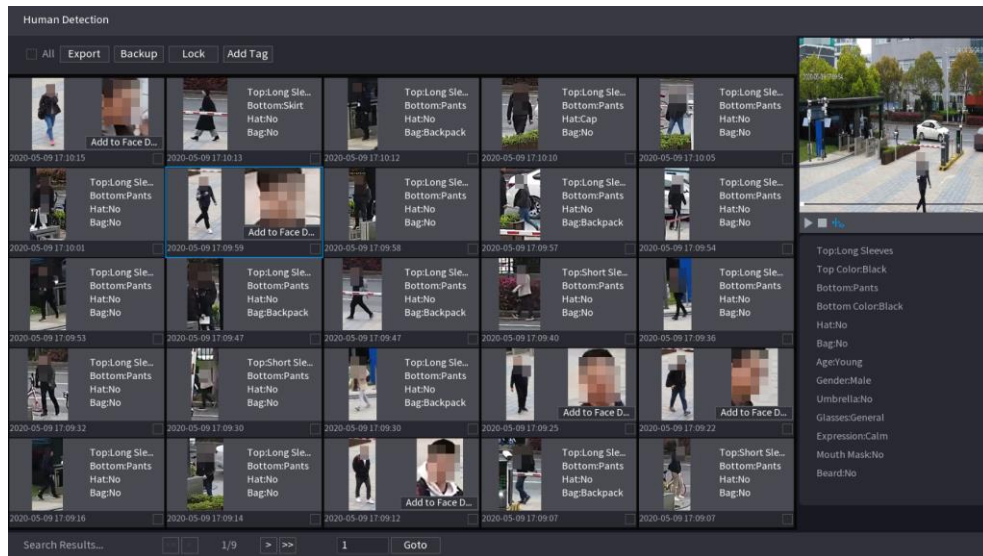

- Step 4** Select one or multiple results, and do the following operations as needed.
- Click **Export** to export results in Excel format.
 - To back up the recorded files to the external storage device, select files, click **Backup**, select the save path and file type, and then click **Start**.
 - To lock the files to make it unable to be overwritten, select the files, and then click **Lock**.
 - To add a tag to the file, select the files and then click **Add Tag**.
 - Click **Add to Face Database** to add the picture to a face database.

4.7.1.6 Motor Vehicle Detection

Background Information

You can search according to the vehicle parameters and search the alarm record during the specified period.



This function is for some series products only.

Procedure

- Step 1** Select **Main Menu > AI > AI Search > Motor Vehicle Detection**.
The **Motor Vehicle Detection** interface is displayed. See Figure 4-125.

Figure 4-125

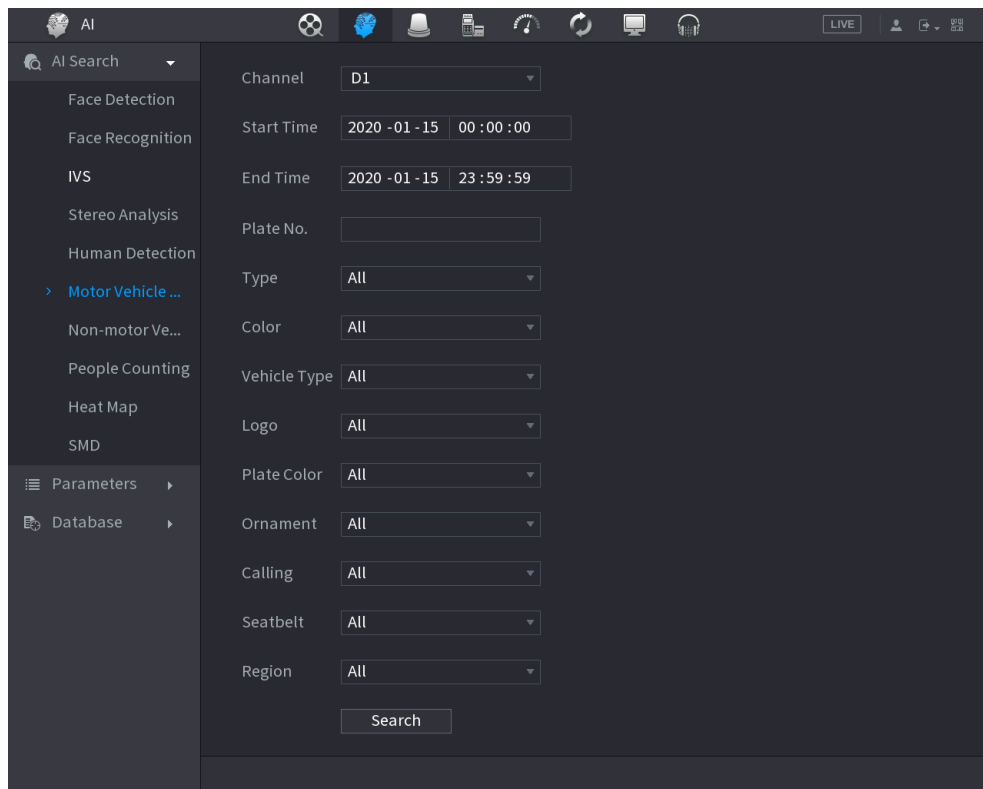

Step 2 Select a channel and set parameters.



- System supports plate fuzzy search.
- System searches all plate numbers by default if you have not set a plate number.

Step 3 Click **Search**.

The search result is displayed.



When black list or white list is selected as **Type**, the black list or white list information will be displayed in search results.

Step 4 Select one or multiple results, and then you can do the following operations as needed.

- 1) To back up the recorded files to the external storage device, select files, click **Backup**, select the save path and file type, and then click **Start**.
- 2) To lock the files to make it unable to be overwritten, select the files, and then click **Lock**.
- 3) To add a mark to the file, select the files and then click **Add Tag**.

4.7.1.7 Non-motor Vehicle Detection

You can search according to the non-motor vehicle parameters and search the alarm record during the specified period.



This function is for some series products only.

Procedure

- Step 1** Select **Main Menu > AI > AI Search > Non-Motor Vehicle Detection** .
The **Non-Motor Vehicle Detection** interface is displayed. See Figure 4-126.

Figure 4-126

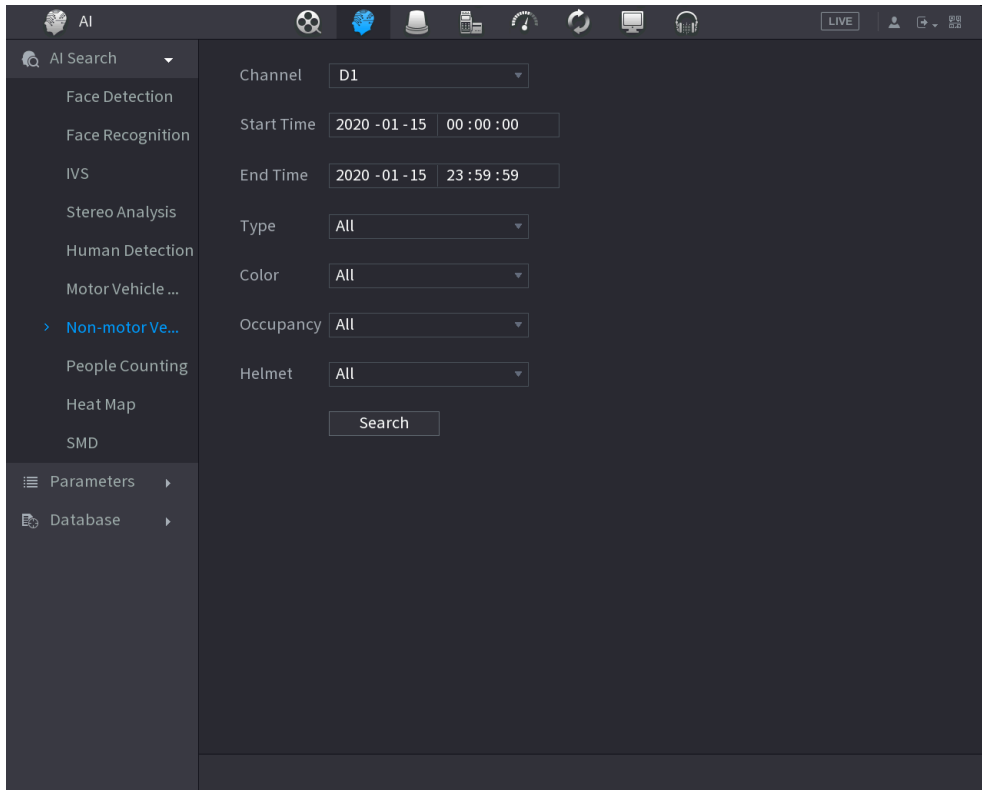

- Step 2** Select the channel and the time, and then select one or multiple features from **Type**, **Color**, **Occupancy**, or **Helmet**.
- Step 3** Click **Search**.
The search result is displayed. See Figure 4-127.

Figure 4-127

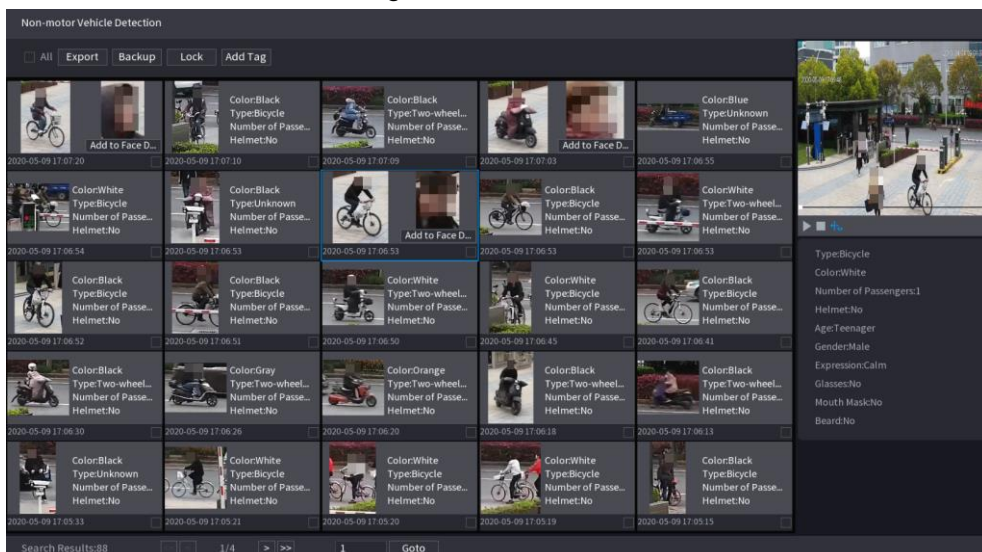

- Step 4** Select one or multiple results, and then you can do the following operations as

needed.

- Click **Export** to export results in Excel format.
- To back up the recorded files to the external storage device, select files, click **Backup**, select the save path and file type, and then click **Start**.
- To lock the files to make it unable to be overwritten, select the files, and then click **Lock**.
- To add a tag to the file, select the files and then click **Add Tag**.
- Click **Add to Face Database** to add the detected face picture to a face database.

4.7.1.8 People Counting

Background Information

You can detect the people amount in the specified zone, and display the statistics image.

Procedure

- Step 1 Select **Main Menu > AI > AI Search > People Counting**.
The **People Counting** interface is displayed. See Figure 4-128.

Figure 4-128

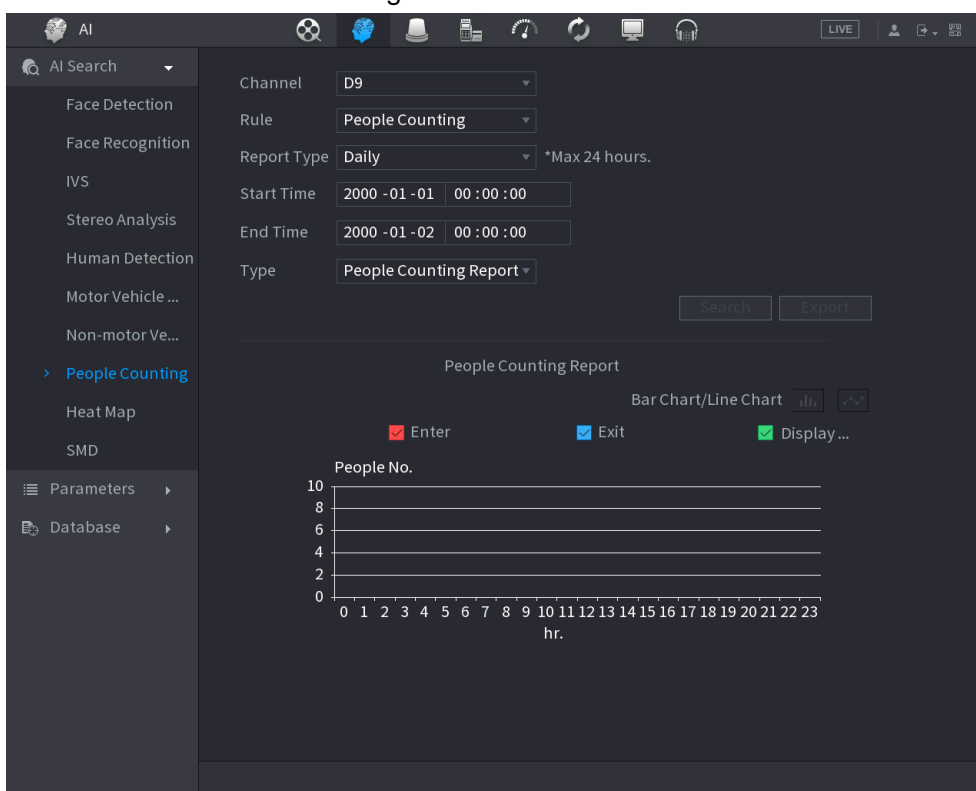

- Step 2 Set parameters such as channel, report type, start time, end time, etc. See Table 4-34.

Table 4-34

Parameter	Description
Channel	Select the channel you want to search people amount.
Rule	Select the rule from the drop-down list.

Parameter	Description
Report Type	Select report type from the drop-down list: daily report, monthly report, yearly report.
Start time/End time	Set search start time and end time.
Type	Select from the drop-down list.

4.7.1.9 Heat map

You can detect the active objects distribution in the monitor zone during the specified period, and use different colors to display on the heat map report.

4.7.1.9.1 General

Procedure

- Step 1 Select **Main Menu > AI > AI Search > Heat Map > General**.
The **General** interface is displayed. See Figure 4-129.

Figure 4-129

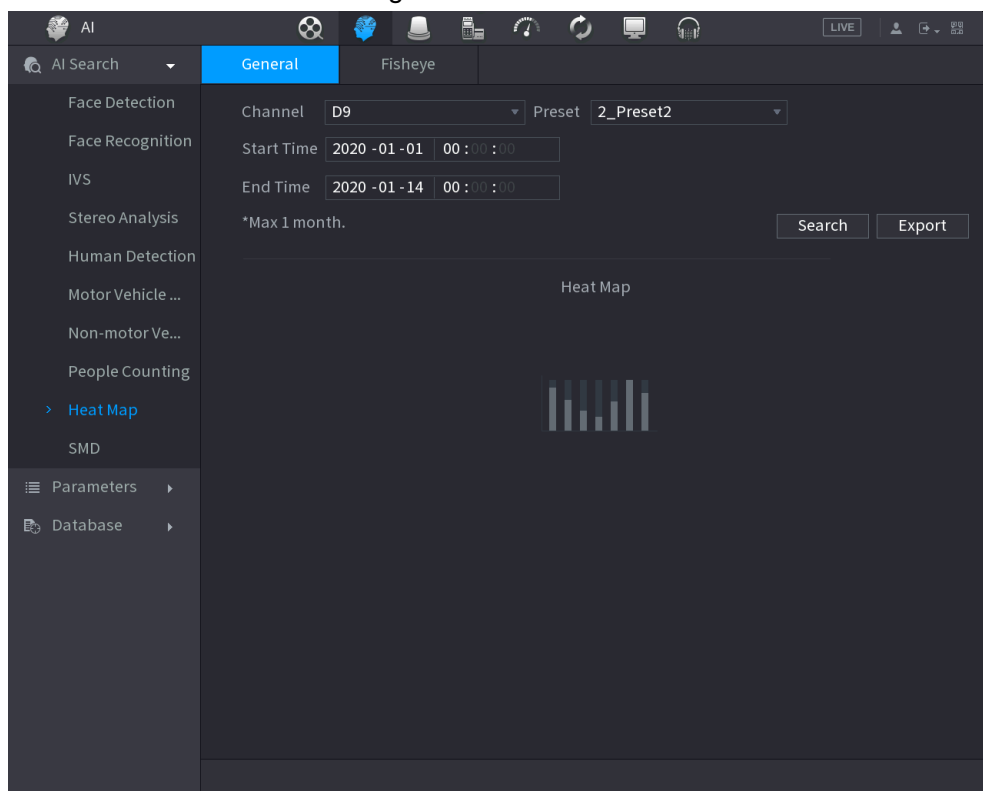

- Step 2 Select channel, start time, end time.
Step 3 Click **Search**.
Step 4 System display heat map report.



Click **Export**, and then select path. Click **Save** to save current report to the USB device.

4.7.1.9.2 Fisheye

Procedure

- Step 1 Select **Main Menu > AI > AI Search > Heat Map > Fisheye**.
The **Fisheye** interface is displayed. See Figure 4-130

Figure 4-130

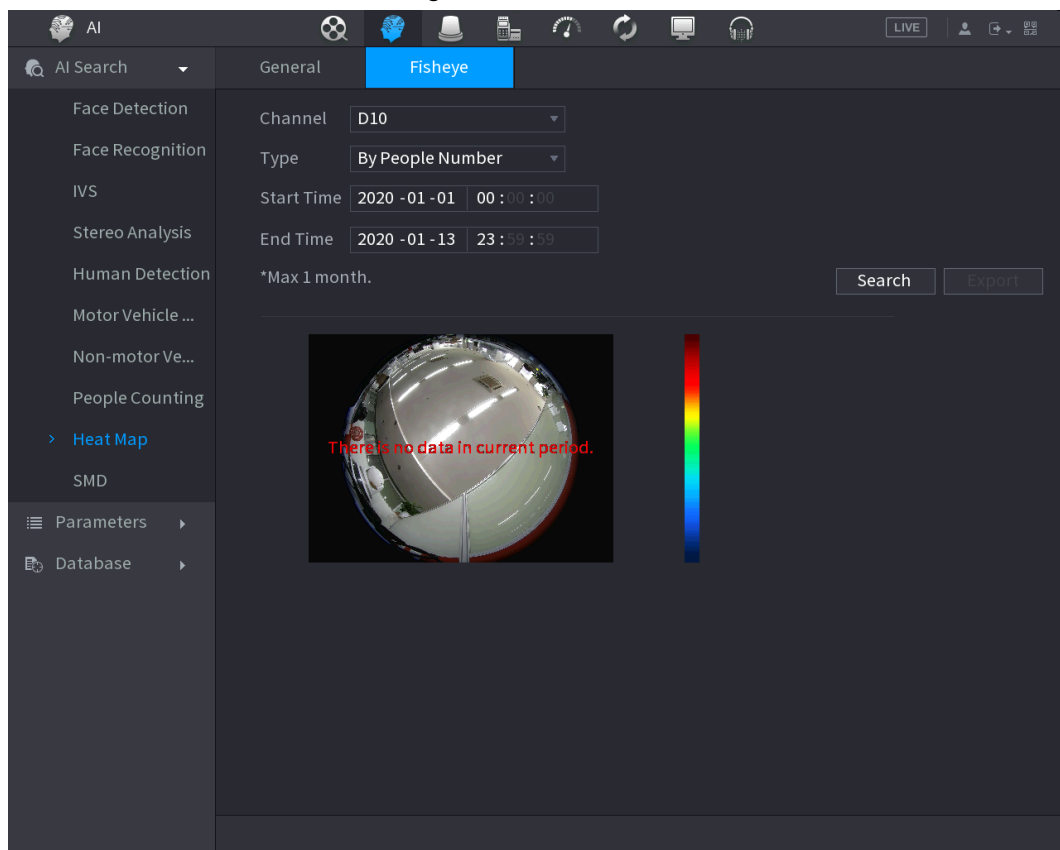

- Step 2 Set **Channel, Type, Start Time, End time**.
Step 3 Click **Search**.
Step 4 System displays heat map report.



Click **Export** and then select saved path, click **Save** to save the heat map report to the USB device.

4.7.1.10 SMD

You can search and play back videos that triggered SMD alarms.

Procedure

- Step 1 Select **Main Menu > AI > AI Search > SMD**.
Step 2 Select channel, type, start time and end time, and then click **Search**.
- Click to play back the video.

- Select a video and click **Export** to export video file to a USB flash drive.

4.7.1.11 Analytics List



This function is for select models only.

Procedure

- Step 1 Select **Main Menu > AI > AI Search > Analytics List**.
- Step 2 Set the values of **Start Time** and **End Time** and select channel(s).

Figure 4-131

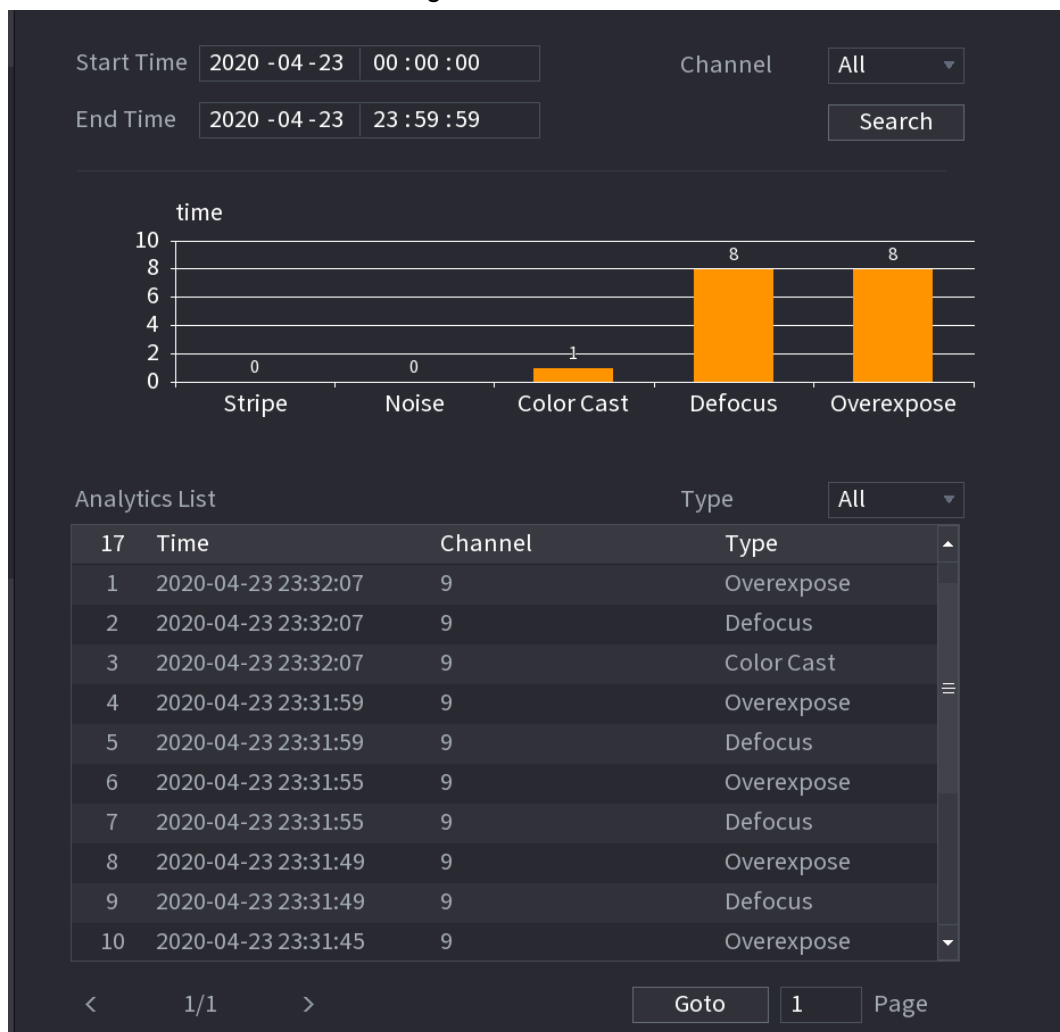

- Step 3 Click **Search**

4.7.2 Parameters

4.7.2.1 Smart Plan

Background Information

The smart plan is for the smart network camera. It includes IVS, human face detection, human

face recognition, human body detection, people counting, heat map. If you do not set a rule here, you cannot use these AI intelligent functions when you are connecting to a smart network camera.

This series NVR products support AI by camera only. Make sure the connected network camera supports intelligent functions. For NVR, it just displays the intelligent alarm information from the smart network camera and set or playback the record file.

Procedure

- Step 1** Select **Main menu > AI > Parameters > Smart Plan**.
The **Smart Plan** interface is displayed. See Figure 4-132.

Figure 4-132

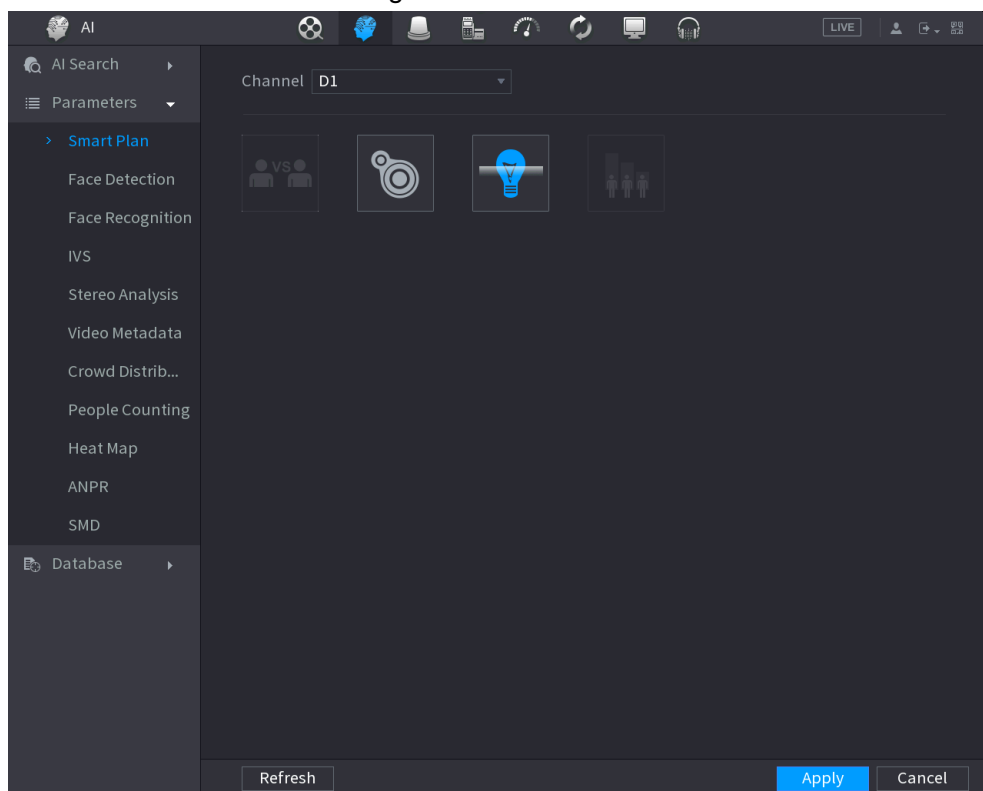

- Step 2** Select a channel number.
System displays different smart plan interfaces since the remote device may supports different functions.
- The interface is shown as Figure 4-133, if the remote device supports preset function.

Figure 4-133

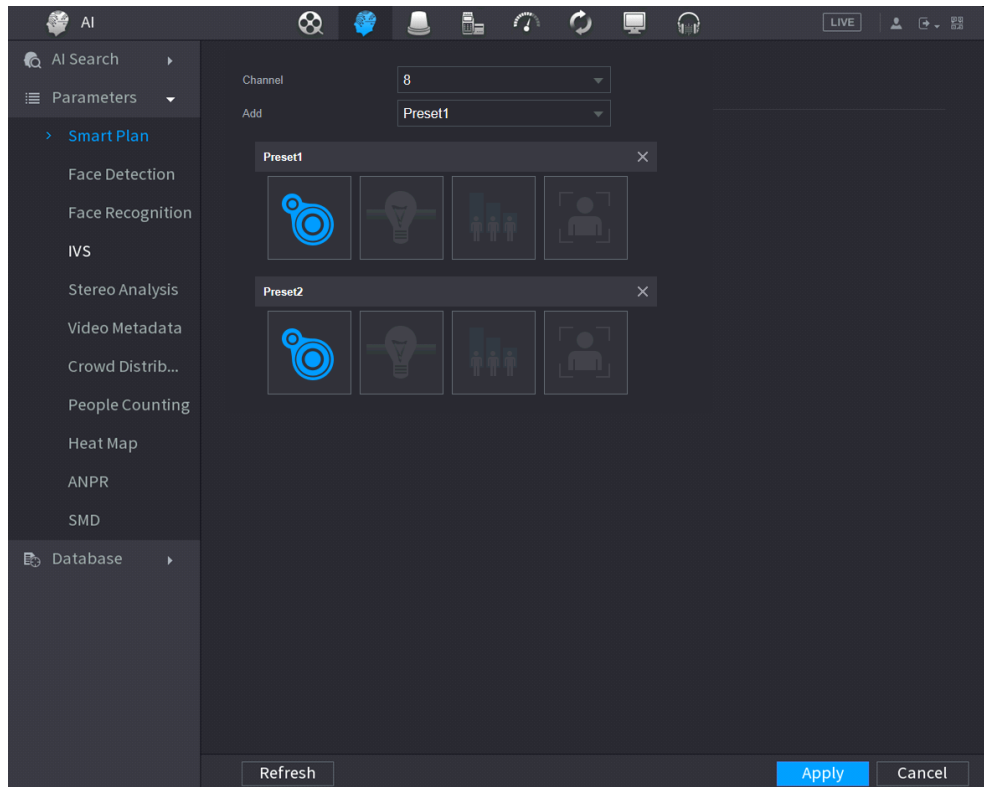

1. Select a channel.
2. Select a preset.
3. Click the smart plan icon at the bottom left. The icon becomes highlighted.
4. Click **Apply**.



- ◇ Click  to delete the preset.
- ◇ Click **Add** to add a preset.
- Once the remote device does not support preset function, the interface is shown as in Figure 4-134.

Figure 4-134



1. Select a channel.
2. Click the smart plan icon. The icon becomes blue highlighted.
3. Click **Apply**.

4.7.2.2 Face Detection

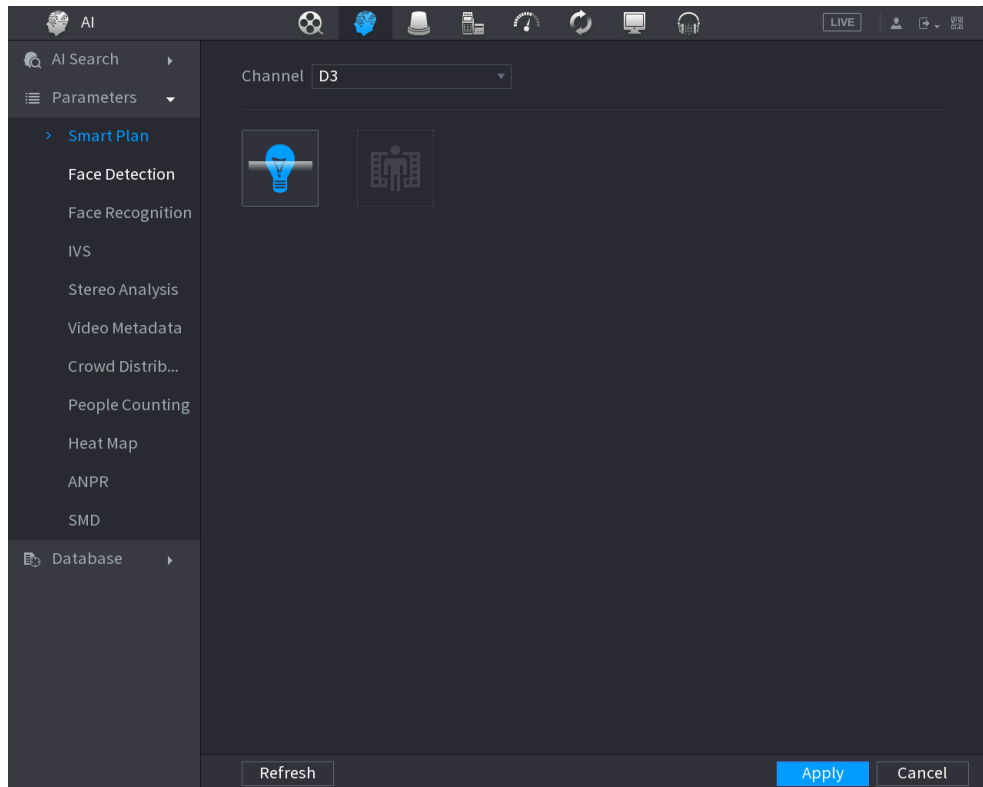
Background Information

The Device can analyze the pictures captured by the camera to detect whether the faces are on the pictures. You can search and filter the recorded videos the faces and play back. The connected camera shall support human face detection function.

Procedure

- Step 1 Select **Main Menu > AI > Parameters > Face Detection**.
The **Face Detection** interface is displayed. See Figure 4-135

Figure 4-135 Face detection

Step 2 In the **Channel** list, select a channel that you want to configure face detection function.

Step 3 In the **Type** list, select **AI by Reorder** or **AI by Camera** as needed.









When **AI by Camera** is selected, you can enable **Face Enhancement** function to improve face detection efficiency.

Step 4 Configure the parameters. See Table 4-35.

Table 4-35 Face detection parameters

Parameter	Description
Enable	Click to enable or disable the face detection.
Rule	Click Setting to draw areas to filter the target. You can configure two filtering targets (maximum size and minimum size). When the target is smaller than the minimum size or larger than the maximum size, no alarms will be activated. The maximum size should be larger than the minimum size. Left click to drag the four angles to adjust the size.
Schedule	Configure the period and in the set time range, the corresponding configuration item will be linked to start the alarm.
Alarm-out Port	The alarm device (such as lights, sirens, etc.) is connected to the alarm output port. When an alarm occurs, the NVR device transmits the alarm information to the alarm device.
Post-Alarm	When the alarm ends, the alarm extended for a period of time. The time range is from 0 seconds to 300 seconds.

Parameter	Description
Report Alarm	<p>Select the check box. When an alarm occurs, the NVR device uploads an alarm signal to the network (including the alarm center).</p>  <ul style="list-style-type: none"> • This function is for some series products only. • You need to set the alarm center first. For details, see "4.11.14 Alarm Center".
Send Email	<p>Select the check box. When an alarm occurs, the NVR device sends an email to the set mailbox to notify the user.</p>  <p>You need to set the email first. For details, see "4.11.11 Email".</p>
Record Channel	<p>Select the check box and select the needed recording channel (support multiple choices). When an alarm occurs, the NVR device activates the channel for recording.</p>  <p>You need to enable intelligent recording and auto recording first. For details, see "4.1.4.6 Schedule".</p>
PTZ Linkage	<p>Select the check box and click Setting to select the channel and PTZ action. When an alarm occurs, the NVR device associates the channel to perform the corresponding PTZ action. For example, activate the PTZ in channel one to turn to the preset point X.</p>  <ul style="list-style-type: none"> • Tripwire alarm supports to activate PTZ preset point only. • You need to set the corresponding PTZ actions first, see "4.4.4 Calling PTZ Functions".
Post-Record	<p>At the end of the alarm, the recording extends for a period of time. The time range is from 10 seconds to 300 seconds.</p>
Tour	<p>Select the check box and select the channel for tour. When an alarm occurs, the local interface of the NVR device displays the selected channel screen.</p>  <ul style="list-style-type: none"> • You need to set the time interval and mode for tour first, see "4.16.2 Tour". • After the tour is over, the preview interface is restored to the screen split mode before the tour.
Log	<p>Select the check box, the NVR device records the alarm information in the log when an alarm occurs.</p>
Alarm Tone	<p>Check the box and then select the corresponding audio file from the drop-down list. System plays the audio file when the alarm occurs.</p>  <p>Refer to "4.17.1 File Management" to add audio file first.</p>

Parameter	Description
Buzzer	Select the check box to activate the buzzer when an alarm occurs.
More	<p>Click More to configure remote alarm output. When alarm event is triggered, the Device links the alarm output ports on camera to trigger an action, such as triggering an access controller to unlock door.</p> <ul style="list-style-type: none"> • Enable: Select the check box to enable the remote alarm output. • Alarm Output: Select the alarm output port as needed. The displayed ports are obtained by Device capability set. • Post-Alarm: When the alarm ends, the camera alarm output setting returns to the previous status after a period of time. The range is from 0 seconds to 300 seconds, and it is 10 seconds by default.

Step 5 Click **Apply** to complete the settings.

4.7.2.3 Face Recognition

Background Information

You can compare the detected faces with the faces in the database to judge if the detected face belongs to the database. The comparison result will be displayed on the AI mode live view screen and smart search interface, and link the alarms.

4.7.2.3.1 Configuring AI by Recorder

Background Information

Make sure the face detection function is enabled at corresponding channel.

Procedure

Step 1 Select **Main Menu > AI > Parameters > Face Recognition**.

Step 2 Select the channel, enable the function, and select **AI by Recorder** in the **Type** list.

Figure 4-136 General alarm (AI by recorder)

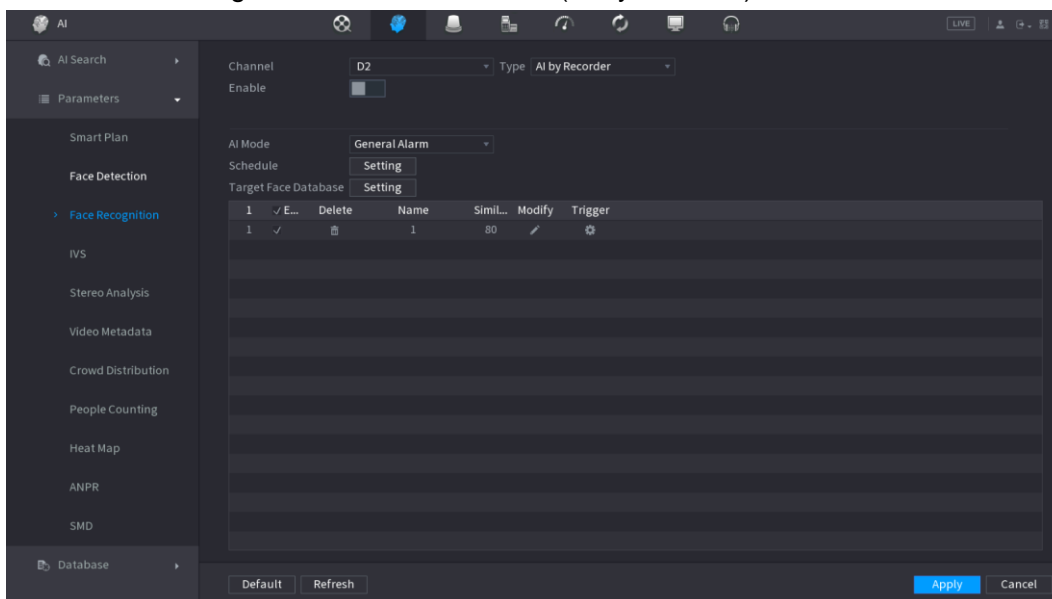

Step 3 Click **Setting** next to **Schedule** to configure arming periods. The corresponding alarm actions are linked by the alarm events triggered during armed period.

Step 4 Arm target face database.

- **General Alarm:** The alarm is triggered when the similarity of detected faces reaches the defined value.

Select **General Alarm** in **AI Mode**, click **Setting** next to **Target Face Database**, select the face database that you want to arm, and then click **OK**.



Click to modify similarity, and click to configure alarm linkages.

- **Stranger Alarm:** The alarm is triggered when the similarity of detected faces does not reach the defined value.

Select **Stranger Alarm** in **AI Mode**, click **Setting** next to **Target Face Database**, enable the function, and then set alarm linkages.

Figure 4-137 Stranger alarm (AI by recorder)

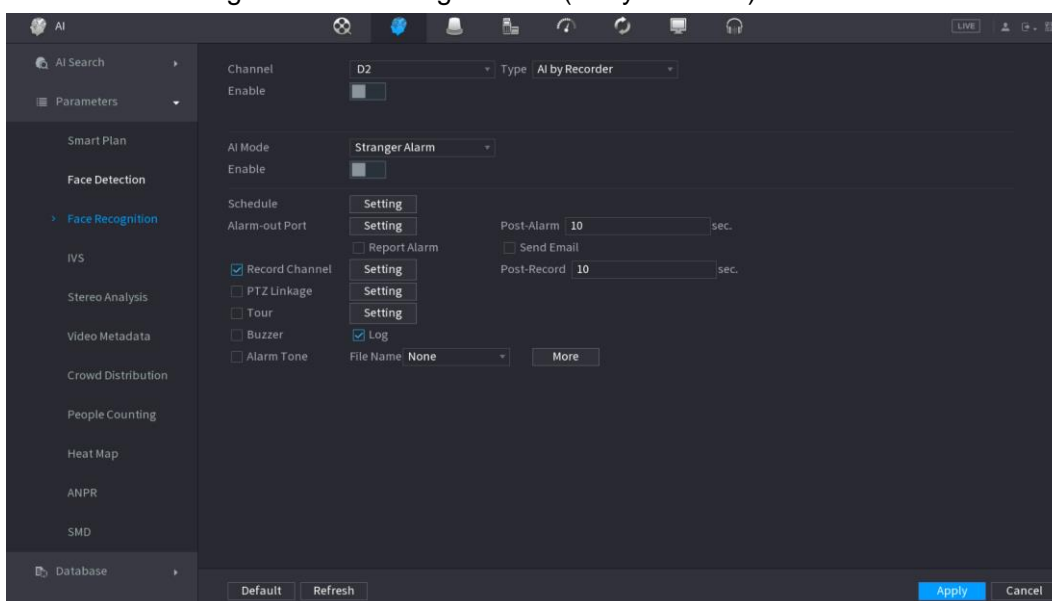

Step 5 Click **Apply**.

4.7.2.3.2 Configuring AI by Camera

Background Information

You can use the connected camera to realize AI function. Make sure the connected camera supports human face detection function.

Procedure

Step 1 Select **Main Menu > AI > Parameters > Face Recognition**.

Step 2 Select the channel, enable the function, and select **AI by Camera** in the **Type** list.

Figure 4-138 AI by camera

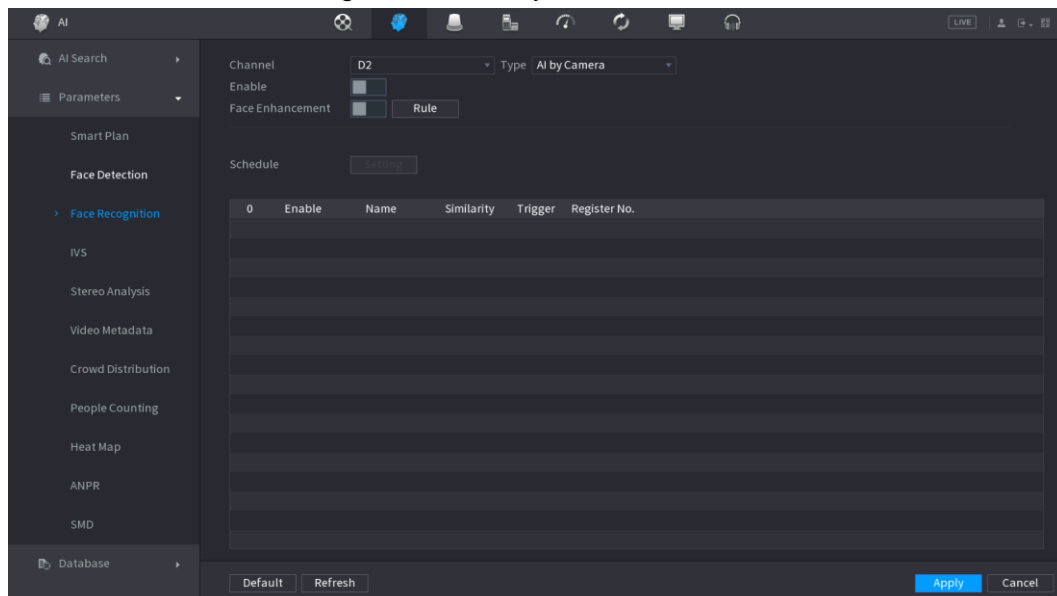

Step 3 Enable **Face Enhancement**. Then system displays human face at the enhanced way.

Step 4 Click **Rule** to draw areas to filter the target.

You can configure two filtering targets (maximum size and minimum size). When the target is smaller than the minimum size or larger than the maximum size, no alarms will be activated. The maximum size should be larger than the minimum size. Click to drag the four angles to adjust the size, and you can also press and move the filtering frame to the required position.

Step 5 Select target face database in the table list, and click to configure alarm linkage.

Step 6 Click **Apply**.

4.7.2.4 IVS (General Behavior Analytics)

Background Information

The IVS function processes and analyzes the images to extract the key information to match with the specified rules. When the detected behaviors match with the rules, the system activates alarms.



- This function is for some series product only.
- IVS function and human face detection function cannot be valid at the same time.

The IVS function environment shall meet the following requirements.

- The object total size shall not be more than 10% of the whole video.
- The object size on the video shall not be more than 10pixels*10 pixels. The abandoned object size shall be more than 15pixels*15 pixels (CIF resolution). The object width shall not be more than 1/3 of the video height and width. The recommended height is 10% of the video.
- The object and the background brightness different shall be more than 10 grey levels.
- The object shall remain on the video for more than 2 seconds. The moving distance is larger than its own width and shall not be smaller than 15pixels (CIF resolution).
- The surveillance environment shall not be too complicated. The IVS function is not suitable for the environment of too many objects or the changing light.
- The surveillance environment shall not contain glasses, reflection light from the ground, and water. Free of tree branches, shadow, mosquito and bugs. Do not use the IVS function in the backlight environment, avoid direct sunlight.

Procedure

Step 1 Select **Main Menu > AI > Parameters > IVS**.

The **IVS** interface is displayed. See Figure 4-139.

Figure 4-139

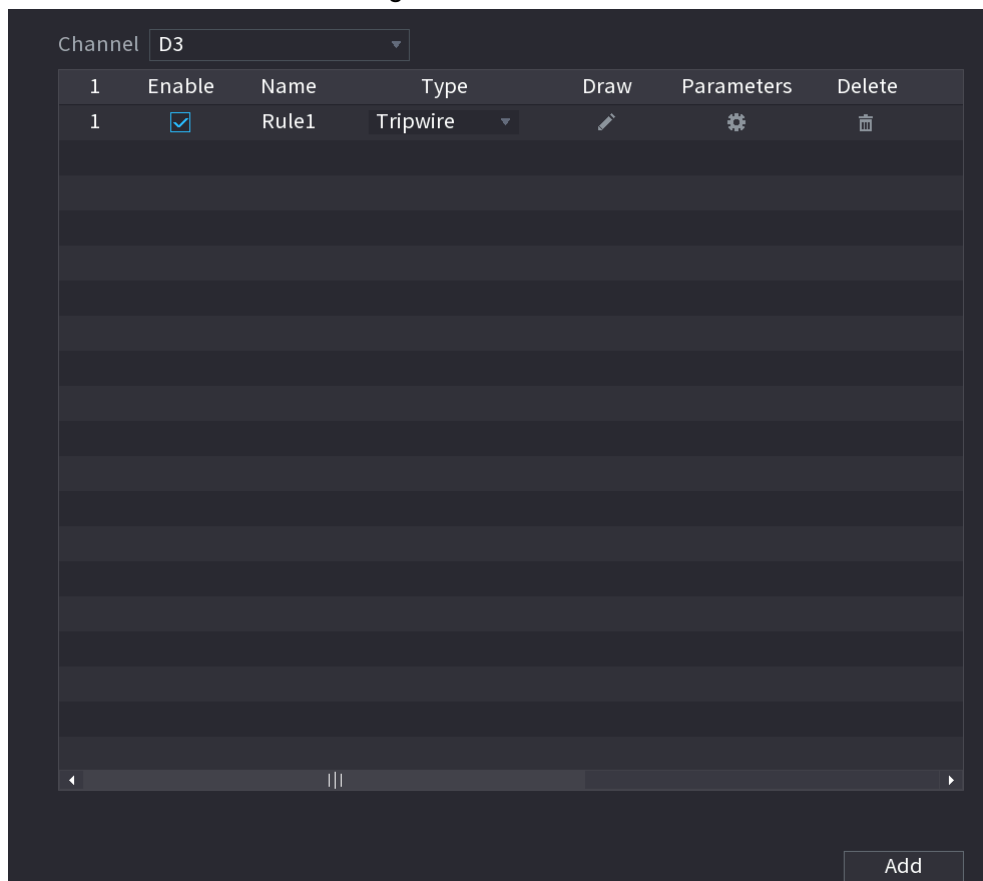

Step 2 Select a channel from the dropdown list.

Click **Add** and then set corresponding rule. See Figure 4-140.



Click  to delete the selected rule.

Figure 4-140



Step 3 Set corresponding parameters.

Step 4 Click **Apply**.

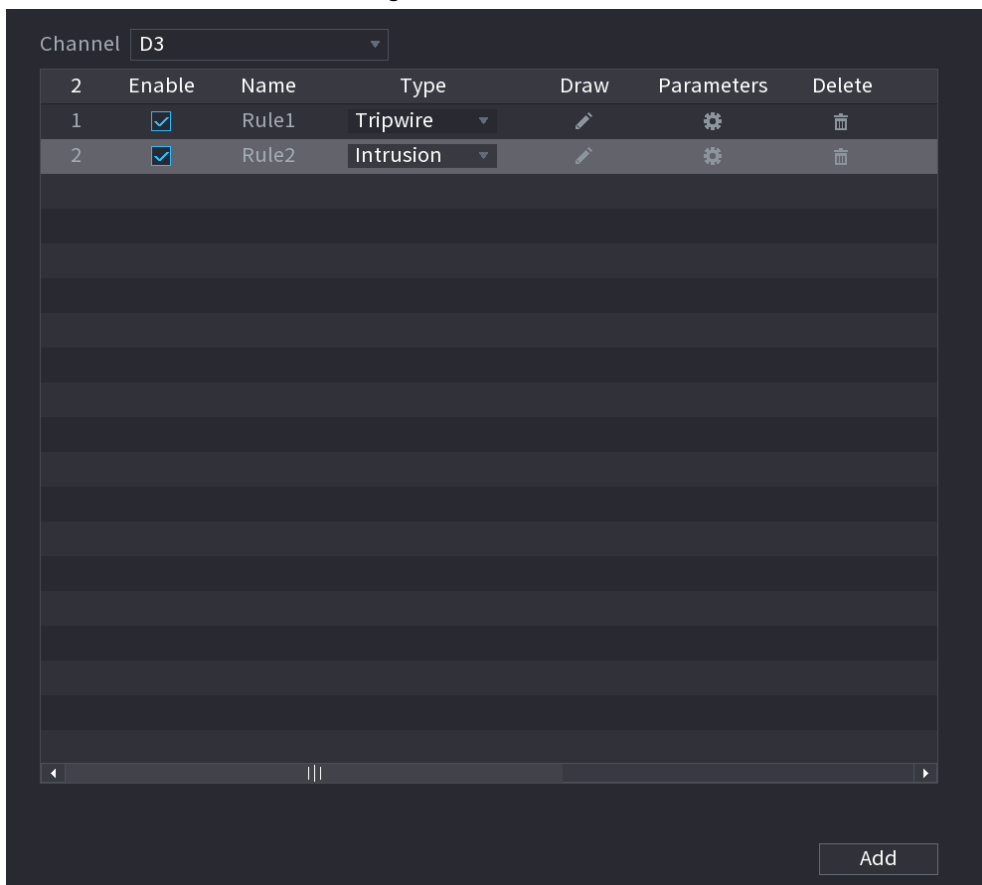
4.7.2.4.1 Tripwire

Background Information

When the detection target crosses the warning line along the set direction, the system performs an alarm linkage action.

Procedure

Step 1 Select **Main Menu > AI > Parameters > IVS**.

In the **Type** drop-down list, select **Tripwire**. See Figure 4-141.

Figure 4-141

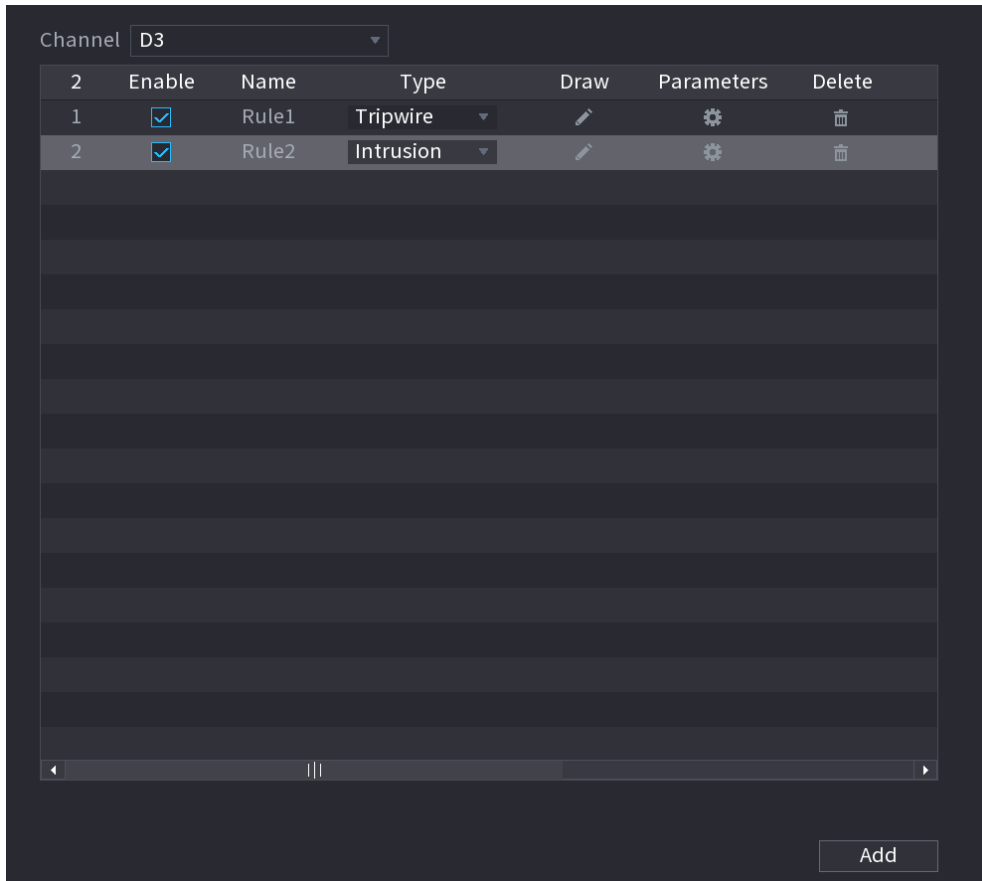

Step 2 Draw the detection rule.

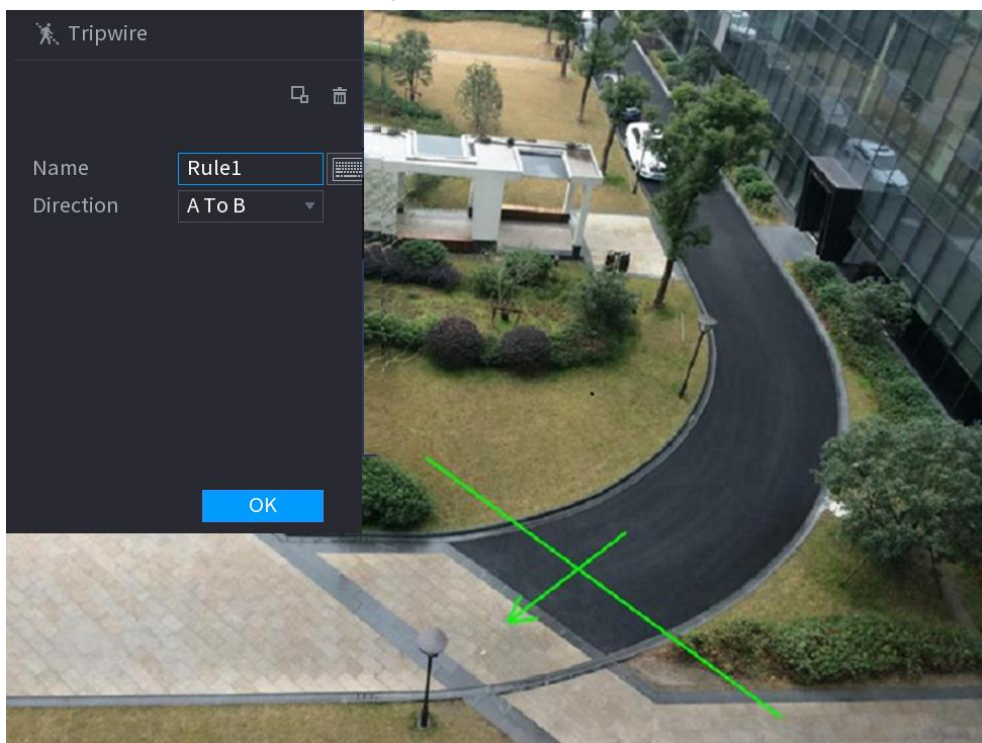

- 1) Click to draw the rule on the surveillance video, the system displays as Figure 4-142.

Figure 4-142



- 2) Configure the parameters. See Table 4-36.

Table 4-36

Parameter	Description
Name	Customize the rule name.
Direction	Set the tripwire direction, including A→B, B→A and A↔B.
Filter target	<p>Click  to filter the target. Check the blue wireframe and adjust the size of the area with the mouse.</p> <p></p> <p>Each rule can set 2 target filters (maximum size and minimum size), that is, when the passing target is smaller than the minimum target or larger than the maximum target, no alarm will be generated. The maximum size should not be smaller than the minimum size.</p>
AI Recognition	<p>Select AI recognition and the system displays alarm target. The default selection is person and motor vehicle and system automatically identifies the person and motor vehicle appeared within the monitoring range.</p> <p></p> <p>When you select IVS of AI by camera, the connected channel shall support tripwire function.</p>

3) Press and hold down the left button on the monitor screen to draw the line. The line can be a straight line or a curve.

4) Click **OK** to complete the rule setting.





Step 3 Click .



The **Parameters** interface is displayed. See Figure 4-143.

Figure 4-143

Step 4 Configure the parameters.

Table 4-37

Parameter	Description
Enable	Click to enable or disable the face detection.
Rule	<p>Click Setting to draw areas to filter the target.</p> <p>You can configure two filtering targets (maximum size and minimum size). When the target is smaller than the minimum size or larger than the maximum size, no alarms will be activated. The maximum size should be larger than the minimum size. Left click to drag the four angles to adjust the size.</p>
Schedule	Configure the period and in the set time range, the corresponding configuration item will be linked to start the alarm.
Alarm-out Port	The alarm device (such as lights, sirens, etc.) is connected to the alarm output port. When an alarm occurs, the NVR device transmits the alarm information to the alarm device.
Post-Alarm	When the alarm ends, the alarm extended for a period of time. The time range is from 0 seconds to 300 seconds.
Report Alarm	<p>Select the check box. When an alarm occurs, the NVR device uploads an alarm signal to the network (including the alarm center).</p>  <ul style="list-style-type: none"> • This function is for some series products only. • You need to set the alarm center first. For details, see "4.11.14 Alarm Center".
Send Email	<p>Select the check box. When an alarm occurs, the NVR device sends an email to the set mailbox to notify the user.</p>  <p>You need to set the email first. For details, see "4.11.11 Email".</p>
Record Channel	<p>Select the check box and select the needed recording channel (support multiple choices). When an alarm occurs, the NVR device activates the channel for recording.</p>  <p>You need to enable intelligent recording and auto recording first. For details, see "4.1.4.6 Schedule".</p>
PTZ Linkage	<p>Select the check box and click Setting to select the channel and PTZ action. When an alarm occurs, the NVR device associates the channel to perform the corresponding PTZ action. For example, activate the PTZ in channel one to turn to the preset point X.</p>  <ul style="list-style-type: none"> • Tripwire alarm supports to activate PTZ preset point only. • You need to set the corresponding PTZ actions first, see "4.4.4 Calling PTZ Functions".

Parameter	Description
Post-Record	At the end of the alarm, the recording extends for a period of time. The time range is from 10 seconds to 300 seconds.
Tour	Select the check box and select the channel for tour. When an alarm occurs, the local interface of the NVR device displays the selected channel screen.  <ul style="list-style-type: none"> You need to set the time interval and mode for tour first, see "4.16.2 Tour". After the tour is over, the preview interface is restored to the screen split mode before the tour.
Log	Select the check box, the NVR device records the alarm information in the log when an alarm occurs.
Alarm Tone	Check the box and then select the corresponding audio file from the dropdown list. System plays the audio file when the alarm occurs.  Refer to "4.17.1 File Management" to add audio file first.
Buzzer	Select the check box to activate the buzzer when an alarm occurs.

Step 5 Click **OK** to save the alarm setting.
System displays the **IVS** interface.

Step 6 Select the **Enable** check box and click **Apply** to complete the tripwire setting.

4.7.2.4.2 Intrusion

Background Information

When the detection target passes the edge of the monitoring area, and enters, leaves or traverses the monitoring area, the system performs an alarm linkage action.

Procedure

Step 1 In the **Type** drop-down list, select **Intrusion**. See Figure 4-144.

Figure 4-144

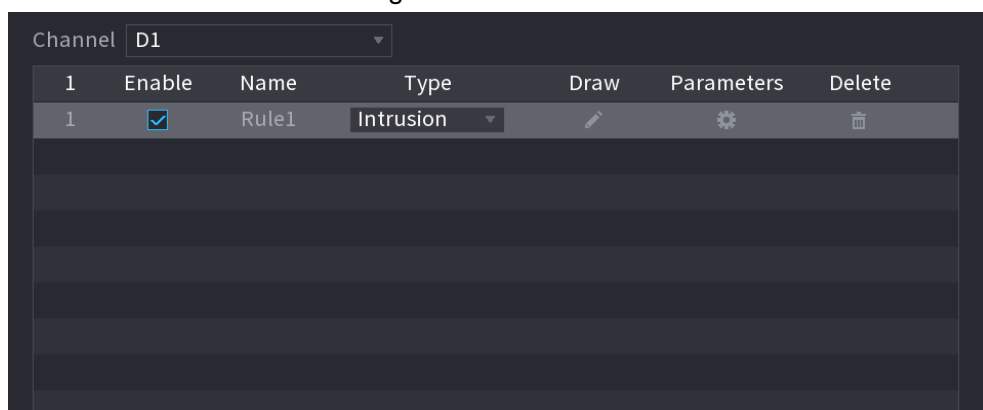

Step 2 Draw the detection rule.

1) Click  to draw the rule on the surveillance video, the system displays as Figure

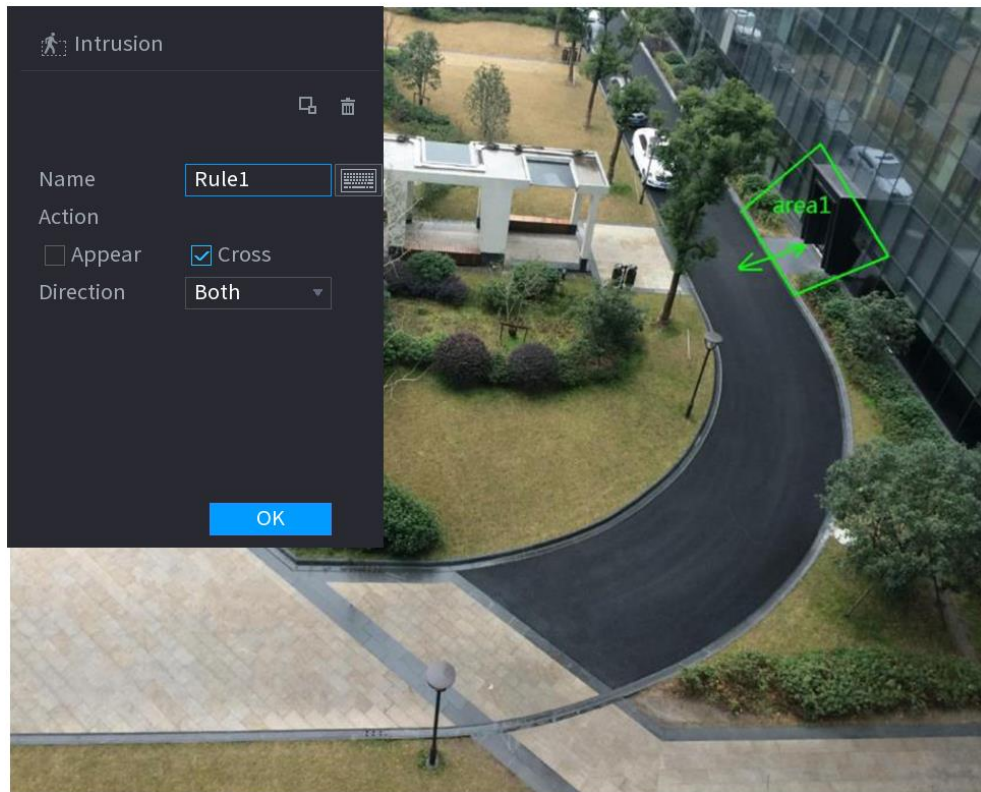

4-145.

Figure 4-145



2) Configure the parameters. See Table 4-36.

Table 4-38

Parameter	Description
Name	Customize the rule name.
Action	Set the intrusion action, including appear and crossing area.
Direction	Set the direction to cross the area, including enter, exit and both.
Filter target	Click  to filter the target. Check the blue wireframe and adjust the size of the area with the mouse.  Each rule can set 2 target filters (maximum size and minimum size), that is, when the passing target is smaller than the minimum target or larger than the maximum target, no alarm will be generated. The maximum size should not be smaller than the minimum size.
AI recognition	Select AI recognition and the system displays alarm target. The default selection is person and motor vehicle and system automatically identifies the person and motor vehicle appeared within the monitoring range.

3) Press and hold down the left button on the monitoring screen to draw the monitoring area.

4) Click **OK** to complete the rule setting.

Step 3 Click , you can refer to "4.7.2.4.1 Tripwire" to set other parameters.

Step 4 Select **Enable** check box and click **Apply** to complete the intrusion setting.

4.7.2.4.3 Abandoned Object Detection

Background Information

System generates an alarm when there is abandoned object in the specified zone.

Procedure

- Step 1** In the **Type** drop-down list, select **Abandoned Object**.
The interface is shown as Figure 4-146.

Figure 4-146

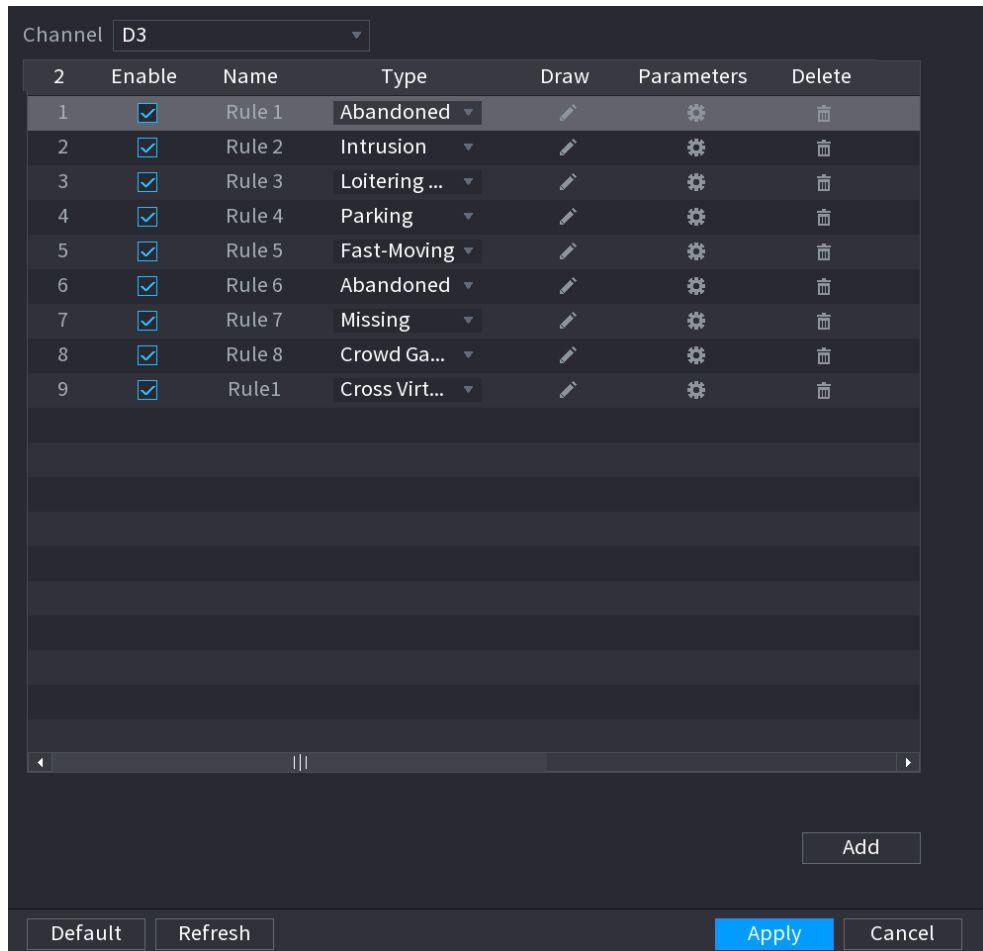

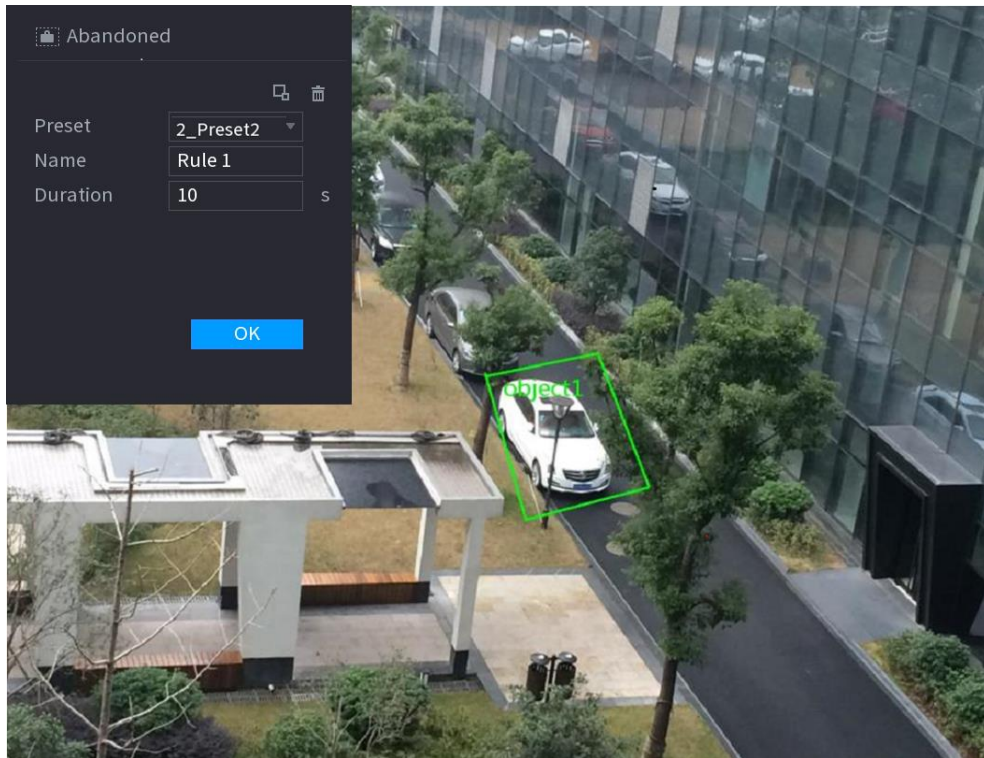

- Step 2** Draw the detection rule.
- 1) Click to draw the rule on the surveillance video. See Figure 4-147.

Figure 4-147



2) Set parameters. See Table 4-39.

Table 4-39

Parameter	Description
Preset	Select a preset you want to use IVS.
Name	Input customized rule name
Duration	System can generate an alarm once the object is in the zone for the specified period.
Filter target	Click  to filter the target. Check the blue wireframe and adjust the size of the area with the mouse.  Each rule can set 2 target filters (maximum size and minimum size), that is, when the passing target is smaller than the minimum target or larger than the maximum target, no alarm will be generated. The maximum size should not be smaller than the minimum size.

3) Draw a rule. Left click mouse to draw a zone, until you draw a rectangle, you can right click mouse.

4) Click **OK** to complete the rule setting.

Step 3 Click , you can refer to "4.7.2.4.1 Tripwire" to set other parameters.

Step 4 Click **Apply** to complete the setup.

4.7.2.4.4 Fast Moving

Background Information

You can detect the fast moving object in the specified zone.

Procedure

- Step 1** In the **Type** drop-down list, select **Fast Moving**.
The interface is shown as below. See Figure 4-148.

Figure 4-148

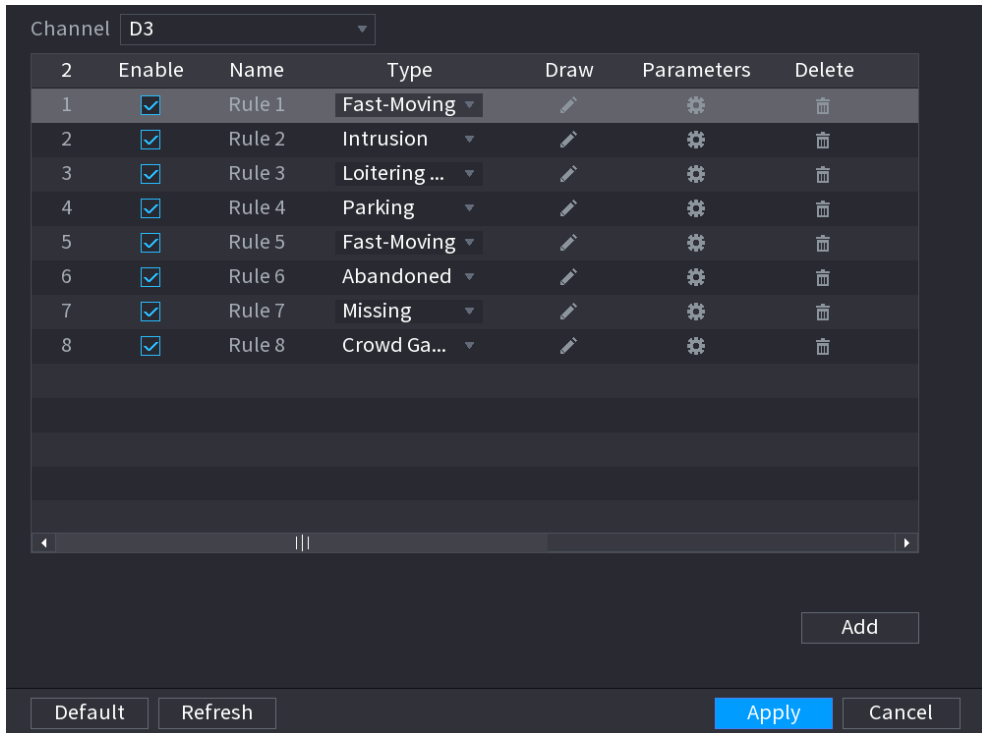

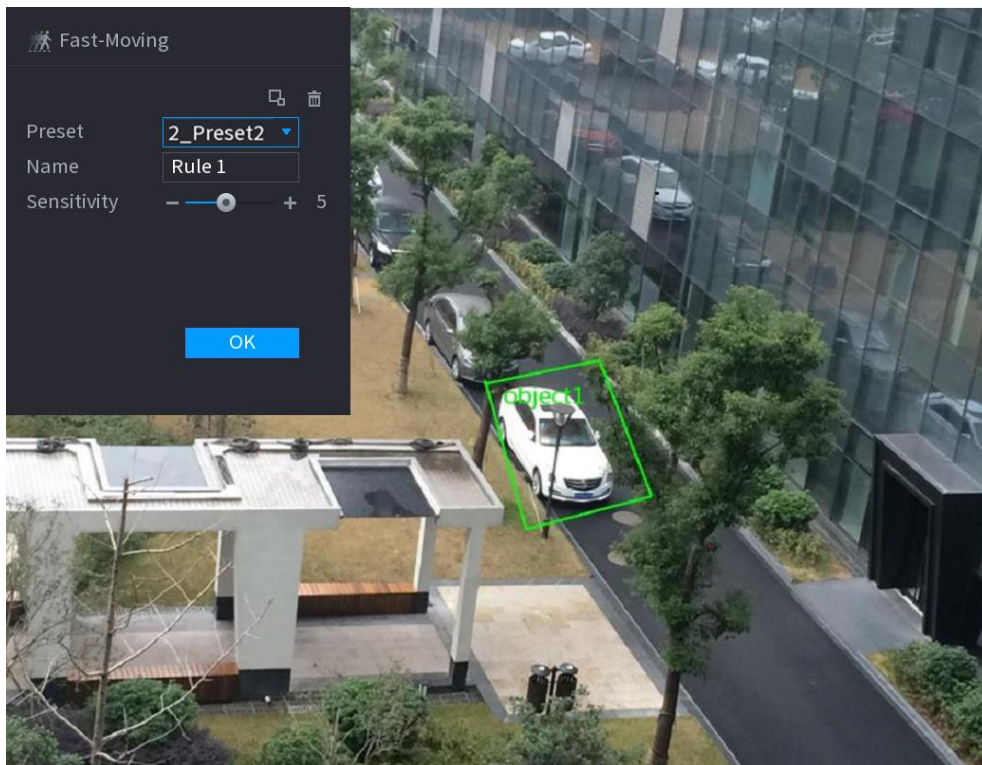

- Step 2** Draw the detection rule.
- 1) Click to draw the rule on the surveillance video. See Figure 4-149.

Figure 4-149



- 2) Set parameters. See Table 4-40.

Table 4-40

Parameter	Description
Preset	Select a preset you want to use IVS
Name	Input customized rule name
Sensitivity	You can set alarm sensitivity. The value ranges from 1 to 10. The default setup is 5.
Filter target	<p>Click  to filter the target. Check the blue wireframe and adjust the size of the area with the mouse.</p> <p></p> <p>Each rule can set 2 target filters (maximum size and minimum size), that is, when the passing target is smaller than the minimum target or larger than the maximum target, no alarm will be generated. The maximum size should not be smaller than the minimum size.</p>

3) Draw a rule. Left click mouse to draw a zone, until you draw a rectangle, you can right click mouse.

4) Click **OK** to complete the rule setting.

Step 3 Click , you can refer to "4.7.2.4.1 Tripwire" to set other parameters.

Step 4 Click **Apply** to complete the setup.

4.7.2.4.5 Crowd Gathering

Background Information

System can generate an alarm once the people amount gathering in the specified zone is larger than the threshold.

Procedure

Step 1 In the **Type** drop-down list, select **Crowd Gathering Estimation**. The interface is shown as below. See Figure 4-150.

Figure 4-150

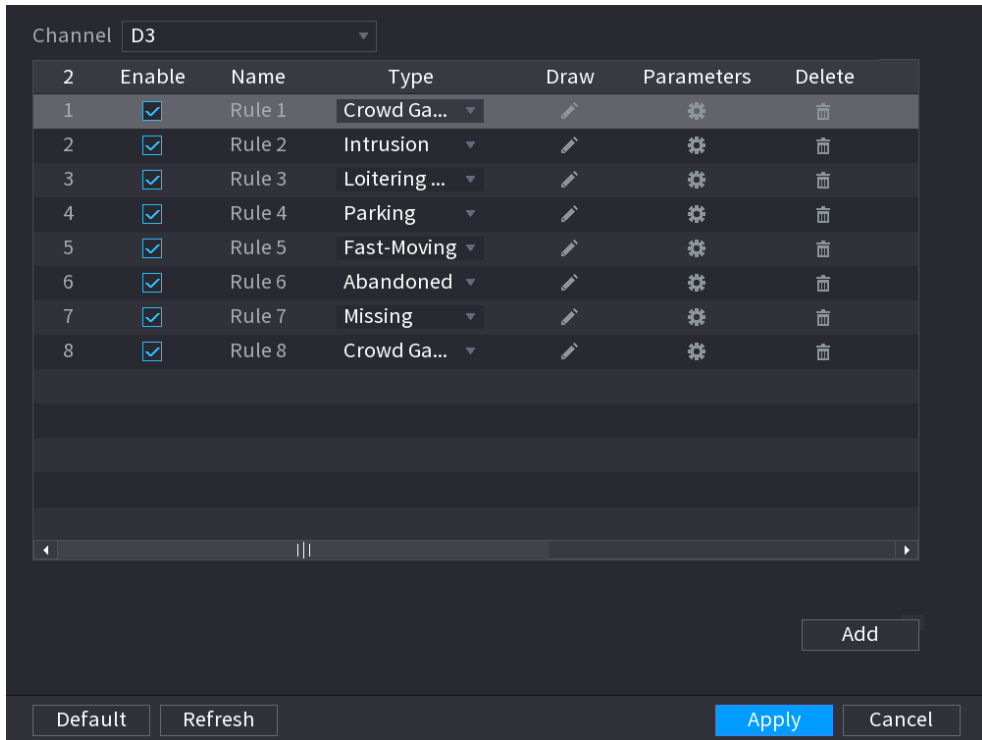

Step 2 Draw the detection rule.

- 1) Click  to draw the rule on the surveillance video. See Figure 4-151.



Figure 4-151

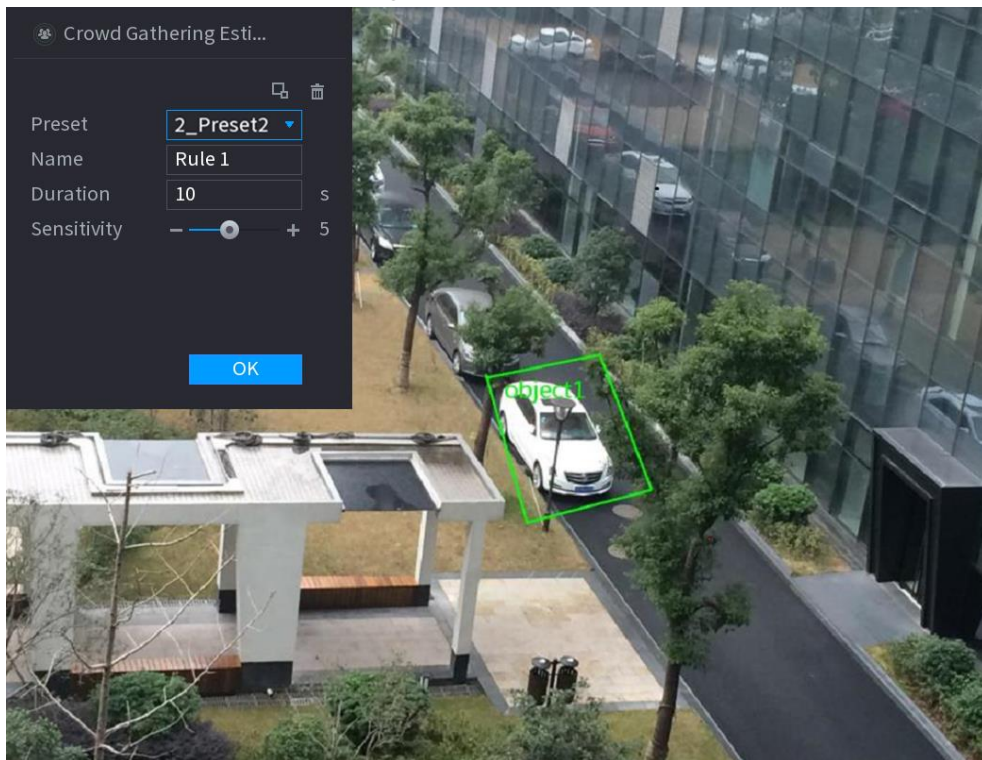

- 2) Set parameters. See Table 4-41.

Table 4-41

Parameter	Description
Preset	Select a preset you want to use IVS.

Parameter	Description
Name	Input customized rule name
Duration	Set the minimum time that the object stays until the alarm is triggered.
Filter target	<p>Click  to filter the target. Check the blue wireframe and adjust the size of the area with the mouse.</p> <p></p> <p>Each rule can set 2 target filters (maximum size and minimum size), that is, when the passing target is smaller than the minimum target or larger than the maximum target, no alarm will be generated. The maximum size should not be smaller than the minimum size.</p>

3) Draw a rule. Left click mouse to draw a zone, until you draw a rectangle, you can right click mouse.

4) Click **OK** to complete the rule setting.

Step 3 Click , you can refer to "4.7.2.4.1 Tripwire" to set other parameters.

Step 4 Click **Apply** to complete the setup.

4.7.2.4.6 Parking

Background Information

When the detection target stays in the monitoring area for more than the set duration, the system performs alarm linkage action.

Procedure

Step 1 In the **Type** drop-down list, select **Parking**.

The interface is shown as below. See Figure 4-152.

Figure 4-152

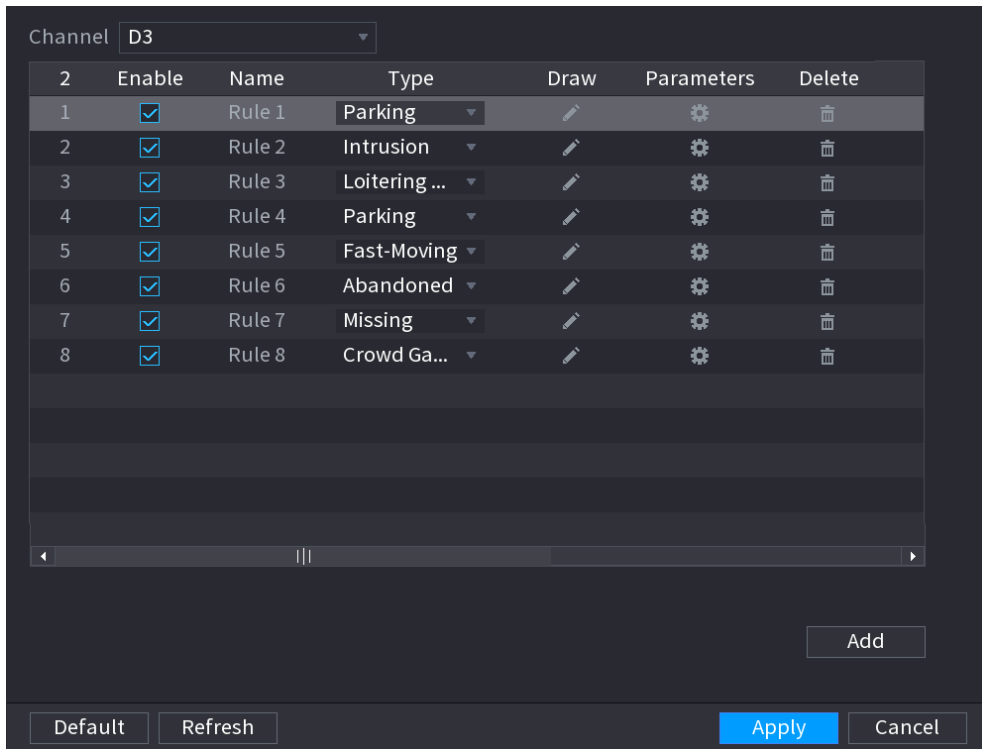

Step 2 Draw the detection rule.

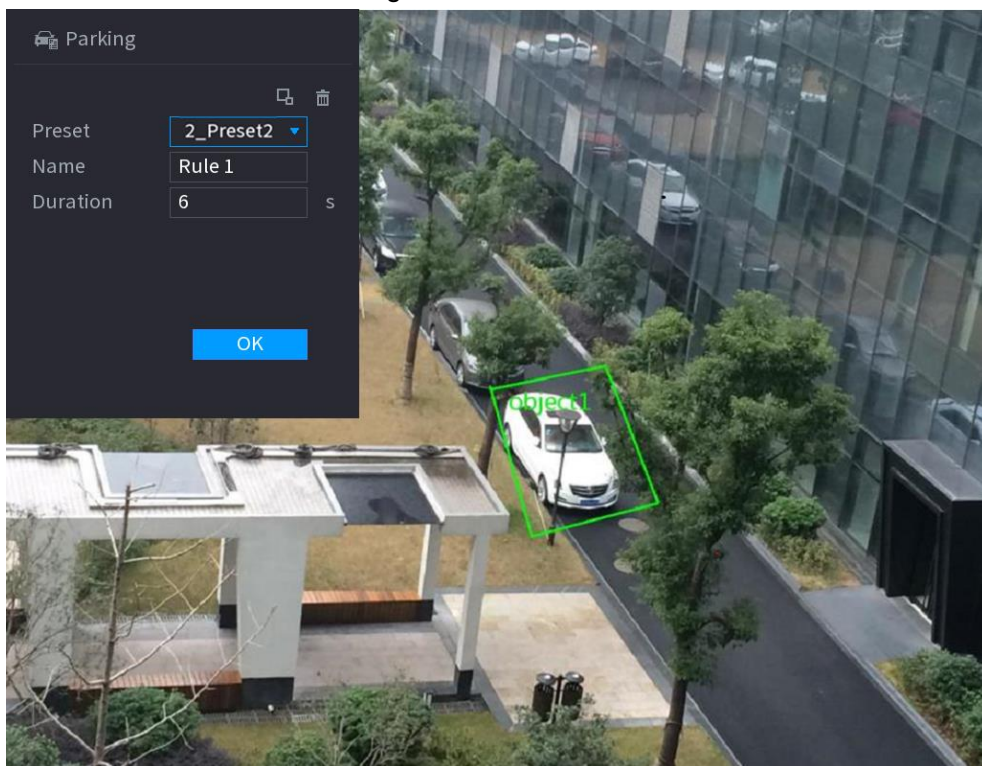

- 1) Click to draw the rule on the surveillance video. See Figure 4-153.

Figure 4-153



- 2) Set parameters. See Table 4-42.

Table 4-42

Parameter	Description
Preset	Set the preset point for IVS detection according to the actual needs.
Name	Customize the rule name.
Duration	Set the minimum time that the object stays until the alarm is triggered.
Filter target	Click  to filter the target. Check the blue wireframe and adjust the size of the area with the mouse.  Each rule can set 2 target filters (maximum size and minimum size), that is, when the passing target is smaller than the minimum target or larger than the maximum target, no alarm will be generated. The maximum size should not be smaller than the minimum size.

3) Draw a rule. Left click mouse to draw a zone, until you draw a rectangle, you can right click mouse.

4) Click **OK** to complete the rule setting.

Step 3 Click , you can refer to "4.7.2.4.1 Tripwire" to set other parameters.

Step 4 Click **Apply** to complete the setup.

4.7.2.4.7 Missing Object Detection

Background Information

System generates an alarm when there is missing object in the specified zone.

Procedure

Step 1 In the **Type** drop-down list, select **Missing Object**.

The interface is shown as below. See Figure 4-154.

Figure 4-154

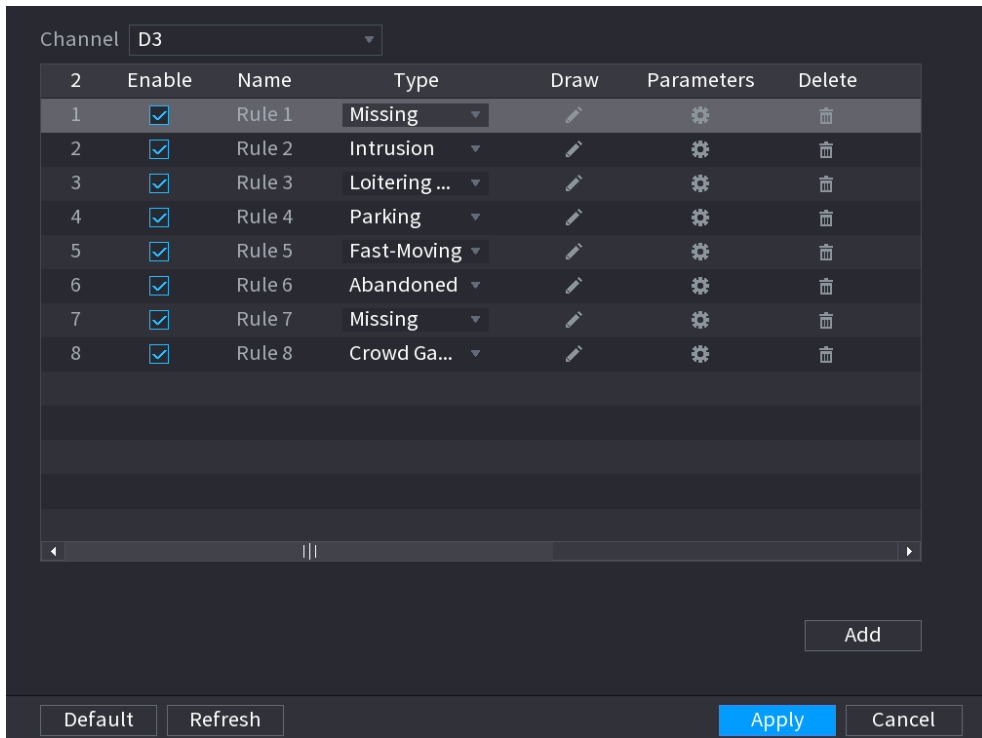

Step 2 Draw the detection rule.

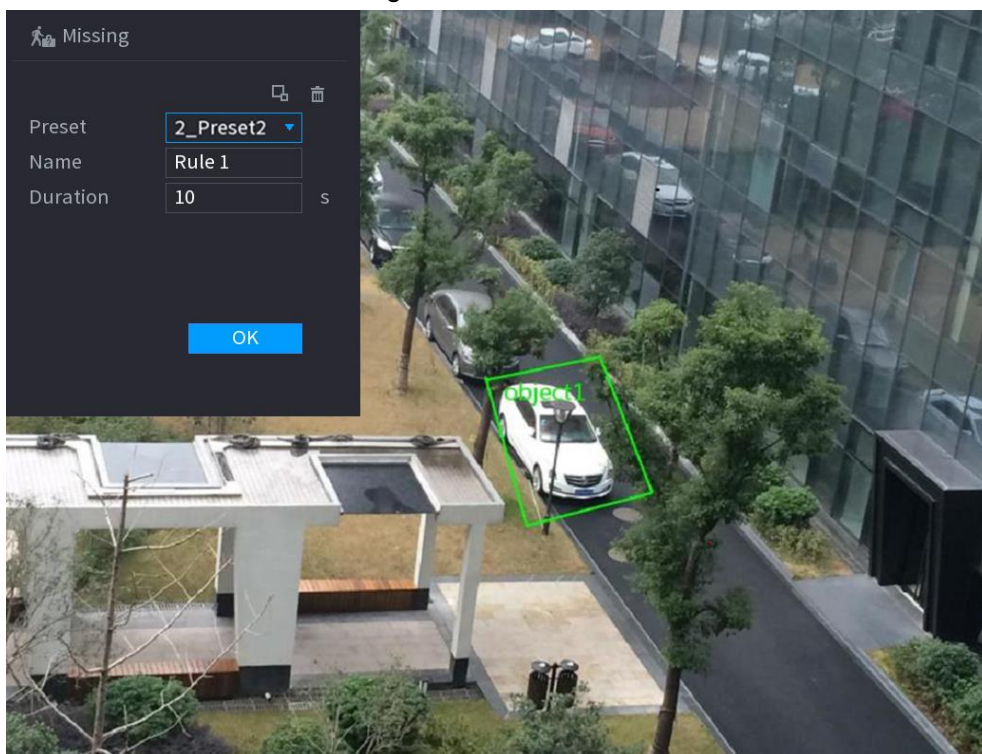

- 1) Click to draw the rule on the surveillance video. See Figure 4-155.

Figure 4-155



- 2) Set parameters. See Table 4-43.

Table 4-43

Parameter	Description
Preset	Set the preset point for IVS detection according to the actual needs.
Name	Customize the rule name.
Duration	Set the minimum time that the object stays until the alarm is triggered.
Filter target	Click  to filter the target. Check the blue wireframe and adjust the size of the area with the mouse.  Each rule can set 2 target filters (maximum size and minimum size), that is, when the passing target is smaller than the minimum target or larger than the maximum target, no alarm will be generated. The maximum size should not be smaller than the minimum size.

3) Draw a rule. Left click mouse to draw a zone, until you draw a rectangle, you can right click mouse.

4) Click **OK** to complete the rule setting.

Step 3 Click , you can refer to "4.7.2.4.1 Tripwire" to set other parameters.

Step 4 Click **Apply** to complete the setup.

4.7.2.4.8 Loitering Detection

Background Information

System can generate an alarm once the object is staying in the specified zone longer than the threshold.

Procedure

Step 1 In the **Type** drop-down list, select **Loitering Detection**.

The interface is shown as below. See Figure 4-156.

Figure 4-156

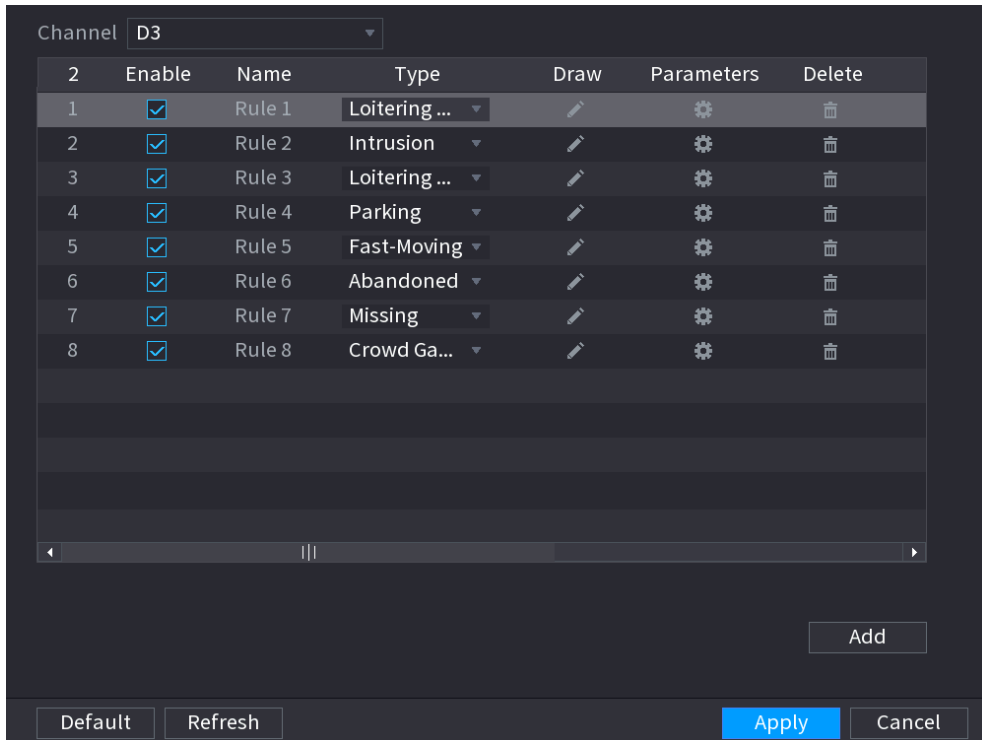

Step 2 Draw the detection rule.

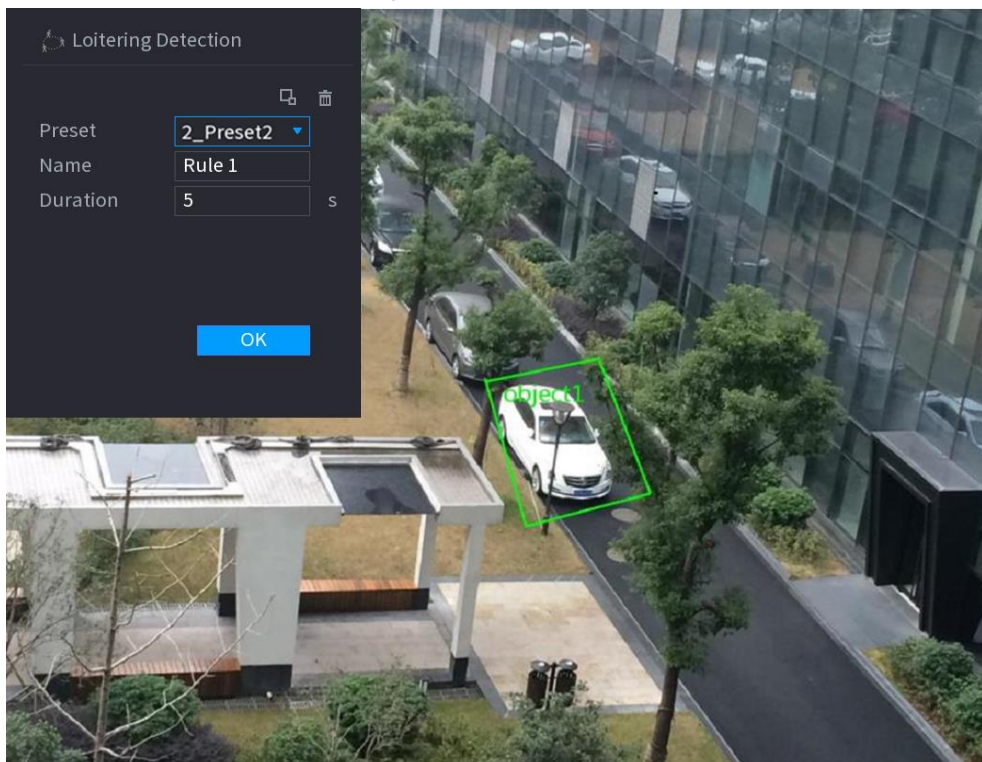

- 1) Click to draw the rule on the surveillance video. See Figure 4-157.

Figure 4-157



- 2) Set parameters. See Table 4-44.

Table 4-44

Parameter	Description
Preset	Set the preset point for IVS detection according to the actual needs.
Name	Customize the rule name.
Duration	Set the minimum time that the object stays until the alarm is triggered.
Filter target	Click  to filter the target. Check the blue wireframe and adjust the size of the area with the mouse.  Each rule can set 2 target filters (maximum size and minimum size), that is, when the passing target is smaller than the minimum target or larger than the maximum target, no alarm will be generated. The maximum size should not be smaller than the minimum size.

3) Draw a rule. Left click mouse to draw a zone, until you draw a rectangle, you can right click mouse.

4) Click **OK** to complete the rule setting.

Step 3 Click , you can refer to "4.7.2.4.1 Tripwire" to set other parameters.

Step 4 Click **Apply** to complete the setup.

4.7.2.5 Video Metadata

The device can detect and extract key features from the human body, motor vehicle, and non-motor vehicles in the video, and then build a structured database. You can search any target you need with these features.

Background Information

After enable the video structuring function, the corresponding smart plan can become valid.



Make sure the connected camera supports video metadata function.

Procedure

Step 1 Select **Main Menu > AI > Parameters > Video Metadata**.

The **Video Metadata** interface is displayed. See Figure 4-158

Figure 4-158

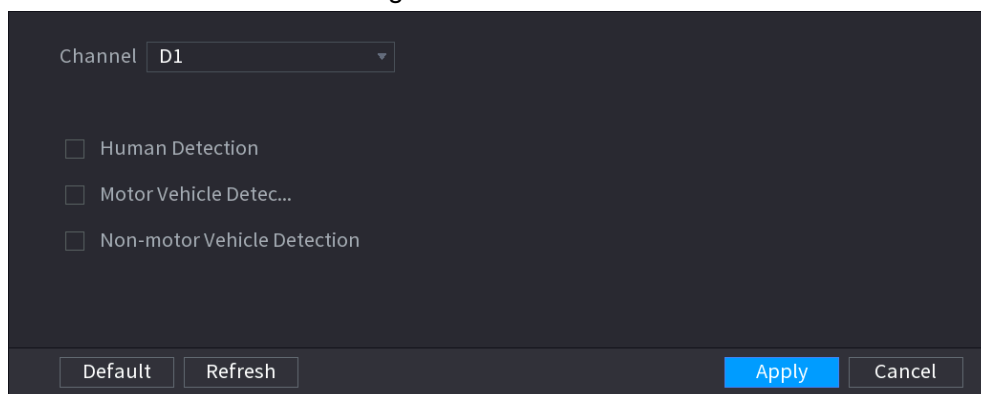

Step 2 In the **Channel** list, select a channel that you want to configure video structuring

function, and then enable it. See Table 4-45

Table 4-45

Parameter	Description
Human Detection	Select Human Detection and then check the box to enable this function.
Face Detection	Select Face Detection and then check the box to enable this function.
Motor Vehicle Detection	Select Motor Vehicle Detection and then check the box to enable this function.
Non-motor Vehicle Detection	Select Non-motor Vehicle Detection and then check the box to enable this function.

Step 3 Click **Apply**.

4.7.2.6 Crowd Distribution

Background Information

Connecting to the front-end device that supports crowd distribution function, system can support the crowd distribution function. It supports crowd distribution event subscription and receive. It supports crowd distribution global and regional density settings, linkage alarm and triggered video storage, or upload the data to the platform. After connecting to the general network camera, the system adopts the algorithm to analyze the crowd density and trigger the corresponding actions.

Procedure





Step 1 Select **Main Menu > AI > Parameters > Crowd Distribution**.
The **Crowd Distribution** interface is displayed. See Figure 4-159.

Figure 4-159 Crowd distribution

Step 2 Configure parameters. See Table 4-46.

Table 4-46

Parameter	Description
Channel	Select a channel from the dropdown list.
Enable	Check the box to enable the function.
Global	Check the box to enable global crowd distribution alarm.
Crowd Density	Configure the alarm threshold. The default setup is 4 persons/m ² . The value ranges from 2 to 10.
Period	Configure the period and in the set time range, the corresponding configuration item will be linked to start the alarm.
Alarm Out	The alarm device (such as lights, sirens, etc.) is connected to the alarm output port. When an alarm occurs, the NVR device transmits the alarm information to the alarm device.
Latch	When the alarm ends, the alarm extended for a period of time. The time range is from 0 seconds to 300 seconds.
Alarm Upload	<p>Select the check box. When an alarm occurs, the NVR device uploads an alarm signal to the network (including the alarm center).</p>  <ul style="list-style-type: none"> • This function is for some series products only. • You need to set the alarm center first. For details, see "4.11.14 Alarm Center".

Parameter	Description
Send Email	<p>Select the check box. When an alarm occurs, the NVR device sends an email to the set mailbox to notify the user.</p>  <p>You need to set the email first. For details, see "4.11.11 Email".</p>
Record Channel	<p>Select the check box and select the needed recording channel (support multiple choices). When an alarm occurs, the NVR device activates the channel for recording.</p>  <p>You need to enable intelligent recording and auto recording first. For details, see "4.1.4.6 Schedule".</p>
PTZ Activation	<p>Select the check box and click Setting to select the channel and PTZ action. When an alarm occurs, the NVR device associates the channel to perform the corresponding PTZ action. For example, activate the PTZ in channel one to turn to the preset point X.</p>  <ul style="list-style-type: none"> • Tripwire alarm supports to activate PTZ preset point only. • You need to set the corresponding PTZ actions first, see "4.4.4 Calling PTZ Functions".
Delay	<p>At the end of the alarm, the recording extends for a period of time. The time range is from 10 seconds to 300 seconds.</p>
Tour	<p>Select the check box and select the channel for tour. When an alarm occurs, the local interface of the NVR device displays the selected channel screen.</p>  <ul style="list-style-type: none"> • You need to set the time interval and mode for tour first, see "4.16.2 Tour". • After the tour is over, the preview interface is restored to the screen split mode before the tour.
Log	<p>Select the check box, the NVR device records the alarm information in the log when an alarm occurs.</p>
Voice Prompts	<p>Check the box and then select the corresponding audio file from the dropdown list. System plays the audio file when the alarm occurs.</p>  <p>Refer to "4.17.1 File Management" to add audio file first.</p>
Buzzer	<p>Select the check box to activate the buzzer when an alarm occurs.</p>

Step 3 Click **Apply** to complete the setup.

4.7.2.7 People Counting

System adopts video image and graphics analysis technology. System can calculate the entry/exit people amount in the specified zone on the video. It can generate an alarm when the amount has exceeded the threshold.

4.7.2.7.1 People Counting

Procedure

- Step 1** Select **Main Menu > AI > Parameters > People Counting > People Counting**. The **People Counting** interface is displayed. See Figure 4-160.

Figure 4-160

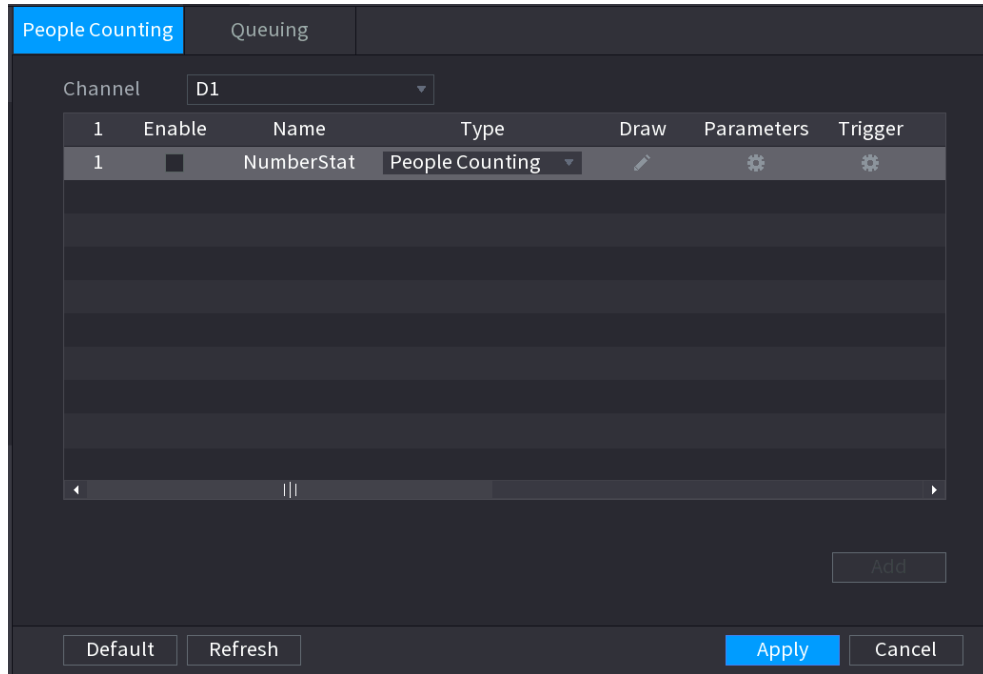



- Step 2** Draw people counting rule.
- 1) Click  to draw people counting rule.
 - 2) Configure parameters.



Table 4-47



Parameter	Description
Name	Customize the rule name.
Duration	Set the minimum time that the object stays until the alarm is triggered.
Filter target	Click  to filter the target. Check the blue wireframe and adjust the size of the area with the mouse.  Each rule can set 2 target filters (maximum size and minimum size), that is, when the passing target is smaller than the minimum target or larger than the maximum target, no alarm will be generated. The maximum size should not be smaller than the minimum size.

- 3) Click and hold the left mouse key to draw an area for people counting.
- 4) Click **OK**.

- Step 3** Click  in both **Parameters** and **Trigger** columns, and configure parameters.

Table 4-48

Parameter	Description
Channel	Select a channel from the dropdown list.
Enable	Check the box to enable the function.
Rule Type	Select a people counting rule type.
Rule	Click RULE to set statistics region, name, direction.
Alarm	<p>Click Setting to set alarm parameters.</p> <p>OSD Overlay: Check the box here; you can view the people amount on the surveillance video.</p> <p>Entry No.: You can set people entry amount. System can generate an alarm once the amount has exceeded the threshold.</p> <p>Exit No.: You can set people exit amount. System can generate an alarm once the amount has exceeded the threshold.</p> <p>Remaining No.: You can set people staying amount in the zone. System can generate an alarm once the amount has exceeded the threshold.</p>
Period	Configure the period and in the set time range, the corresponding configuration item will be linked to start the alarm.
Alarm Out	The alarm device (such as lights, sirens, etc.) is connected to the alarm output port. When an alarm occurs, the NVR device transmits the alarm information to the alarm device.
Latch	When the alarm ends, the alarm extended for a period of time. The time range is from 0 seconds to 300 seconds.
Alarm Upload	<p>Select the check box. When an alarm occurs, the NVR device uploads an alarm signal to the network (including the alarm center).</p> <p></p> <ul style="list-style-type: none"> • This function is for some series products only. • You need to set the alarm center first. For details, see "4.11.14 Alarm Center".
Send Email	<p>Select the check box. When an alarm occurs, the NVR device sends an email to the set mailbox to notify the user.</p> <p></p> <p>You need to set the email first. For details, see "4.11.11 Email".</p>
Record Channel	<p>Select the check box and select the needed recording channel (support multiple choices). When an alarm occurs, the NVR device activates the channel for recording.</p> <p></p> <p>You need to enable intelligent recording and auto recording first. For details, see "4.1.4.6 Schedule".</p>

Parameter	Description
PTZ Activation	<p>Select the check box and click Setting to select the channel and PTZ action. When an alarm occurs, the NVR device associates the channel to perform the corresponding PTZ action. For example, activate the PTZ in channel one to turn to the preset point X.</p>  <ul style="list-style-type: none"> • Tripwire alarm supports to activate PTZ preset point only. • You need to set the corresponding PTZ actions first, see "4.4.4 Calling PTZ Functions".
Delay	<p>At the end of the alarm, the recording extends for a period of time. The time range is from 10 seconds to 300 seconds.</p>
Tour	<p>Select the check box and select the channel for tour. When an alarm occurs, the local interface of the NVR device displays the selected channel screen.</p>  <ul style="list-style-type: none"> • You need to set the time interval and mode for tour first, see "4.16.2 Tour". • After the tour is over, the preview interface is restored to the screen split mode before the tour.
Log	<p>Select the check box, the NVR device records the alarm information in the log when an alarm occurs.</p>
Voice Prompts	<p>Check the box and then select the corresponding audio file from the dropdown list. System plays the audio file when the alarm occurs.</p>  <p>Refer to "4.17.1 File Management" to add audio file first.</p>
Buzzer	<p>Select the check box to activate the buzzer when an alarm occurs.</p>

Step 4 Click **Apply**.

4.7.2.7.2 Queuing

Background Information

After connecting to the AI fisheye camera that supports the queuing function, system can realize the corresponding linkage actions once the people amount in the queue or the waiting time has trigger an alarm. Select a region first to set the corresponding actions. For the same line, the queue people number alarm and queue time alarm has the same linkage actions.

Procedure

Step 1 Select **Main Menu > AI > Parameters > People Counting > Queuing**.

Step 2 The **Queuing** interface is displayed. See Figure 4-161.



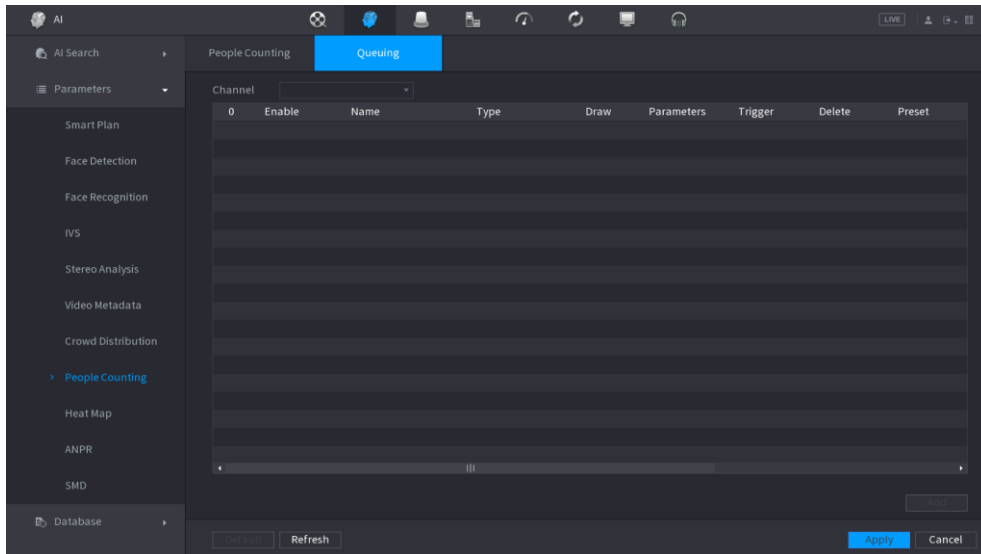

Figure 4-161



- Step 3** Select Channel, and then click **Add**.
- Step 4** Select the **Enable** check box.
- Step 5** Click to draw queuing rule and area.
- Step 6** Click under the **Parameters** column, and then select alarm type to **Queue People No. Alarm** or **Queue Time Alarm**.
- Step 7** Click under the **Trigger** column, and configure alarm linkages.

Table 4-49

Parameter	Description
Period	Configure the period and in the set time range, the corresponding configuration item will be linked to start the alarm.
Alarm Out	The alarm device (such as lights, sirens, etc.) is connected to the alarm output port. When an alarm occurs, the NVR device transmits the alarm information to the alarm device.
Latch	When the alarm ends, the alarm extended for a period of time. The time range is from 0 seconds to 300 seconds.
Alarm Upload	Select the check box. When an alarm occurs, the NVR device uploads an alarm signal to the network (including the alarm center). <ul style="list-style-type: none"> This function is for some series products only. You need to set the alarm center first. For details, see "4.11.14 Alarm Center".
Send Email	Select the check box. When an alarm occurs, the NVR device sends an email to the set mailbox to notify the user. You need to set the email first. For details, see "4.11.11 Email".

Parameter	Description
Record Channel	<p>Select the check box and select the needed recording channel (support multiple choices). When an alarm occurs, the NVR device activates the channel for recording.</p>  <p>You need to enable intelligent recording and auto recording first. For details, see "4.1.4.6 Schedule".</p>
PTZ Activation	<p>Select the check box and click Setting to select the channel and PTZ action. When an alarm occurs, the NVR device associates the channel to perform the corresponding PTZ action. For example, activate the PTZ in channel one to turn to the preset point X.</p>  <ul style="list-style-type: none"> • Tripwire alarm supports to activate PTZ preset point only. • You need to set the corresponding PTZ actions first, see "4.4.4 Calling PTZ Functions".
Delay	<p>At the end of the alarm, the recording extends for a period of time. The time range is from 10 seconds to 300 seconds.</p>
Tour	<p>Select the check box and select the channel for tour. When an alarm occurs, the local interface of the NVR device displays the selected channel screen.</p>  <ul style="list-style-type: none"> • You need to set the time interval and mode for tour first, see "4.16.2 Tour". • After the tour is over, the preview interface is restored to the screen split mode before the tour.
Log	<p>Select the check box, the NVR device records the alarm information in the log when an alarm occurs.</p>
Voice Prompts	<p>Check the box and then select the corresponding audio file from the dropdown list. System plays the audio file when the alarm occurs.</p>  <p>Refer to "4.17.1 File Management" to add audio file first.</p>
Buzzer	<p>Select the check box to activate the buzzer when an alarm occurs.</p>

Step 8 Click **Apply**.

4.7.2.8 Heat map

Background Information

Heat map technology can monitor the active objects distribution status on the specified zone during a period of time, and use the different colors to display on the heat map.

Procedure

Step 1 Select **Main Menu > AI > Parameters > Heat Map**.
The **Heat Map** interface is displayed. See Figure 4-162.

Figure 4-162

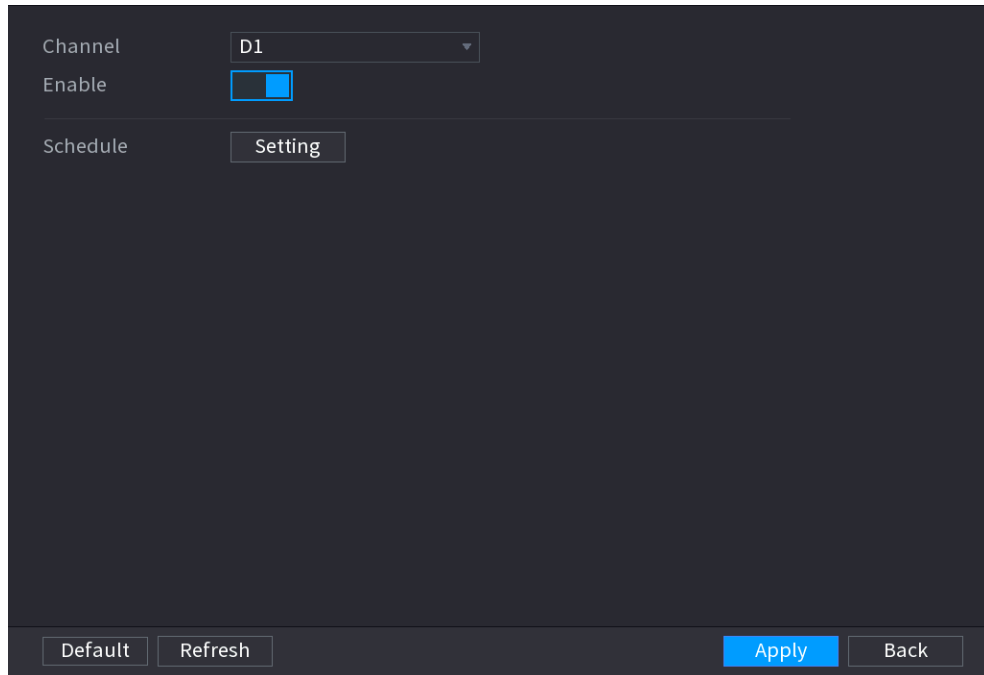

Step 2 Select a channel number and then check the box to enable the function.

Step 3 Click **Setting**.

The **Setting** interface is displayed. See Figure 4-163.

Figure 4-163

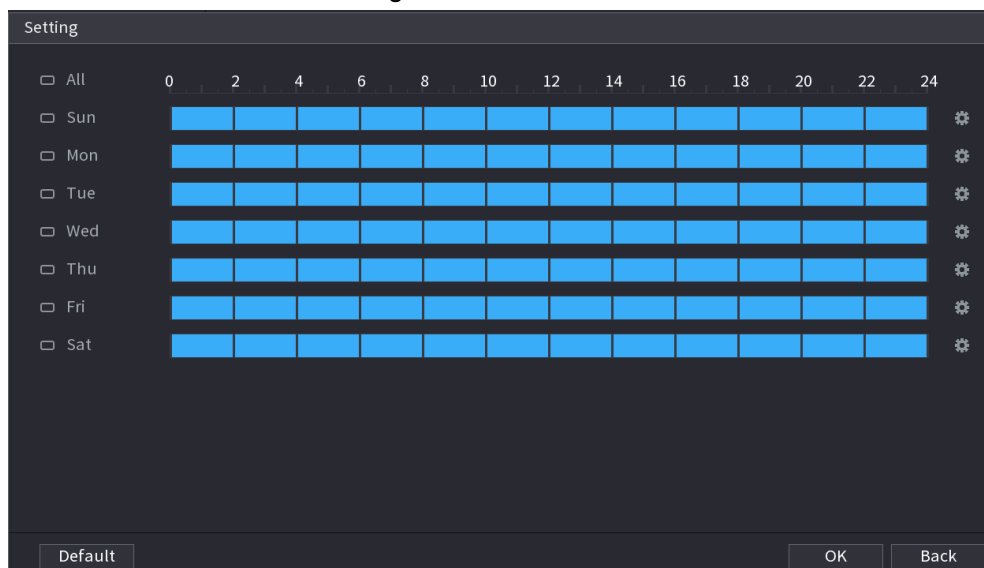

Step 4 Set arm/disarm period. There are two modes for you to set the period so that the system can detect the specified zone.

- Define the period by drawing.
 - Select the corresponding date and then use mouse to drag the bar to set period.
 - ◇ Define for the whole week: Click next to **All**, all the icon switches to , you can define the period for all the days simultaneously.
 - ◇ Define for several days of a week: Click before each day one by one, the icon switches to . You can define the period for the selected days simultaneously.
- Define the period by editing.
 1. Click of the corresponding date, and then set the period on the pop-up

interface. Click **OK** to save.

- ◇ There are six periods for you to set for each day.
- ◇ Under **Copy**, select **All** to apply the settings to all the days of a week, or select specific day(s) that you want to apply the settings to.

2. Click **Apply** to save the settings.

Step 5 Click **Apply** button to complete setup.

4.7.2.9 ANPR

Background Information

System uses the video recognition technology to extract the plate number on the surveillance video and then compare it with the specified plate information. System can trigger an alarm once there is a matched result.

You can set different plate recognition rule, alarm linkage actions in different environments (blocklist, allowlist and regular).

Procedure

Step 1 Select **Main Menu > AI > Parameters > ANPR**.

The **ANPR** interface is displayed. See Figure 4-164.

Figure 4-164

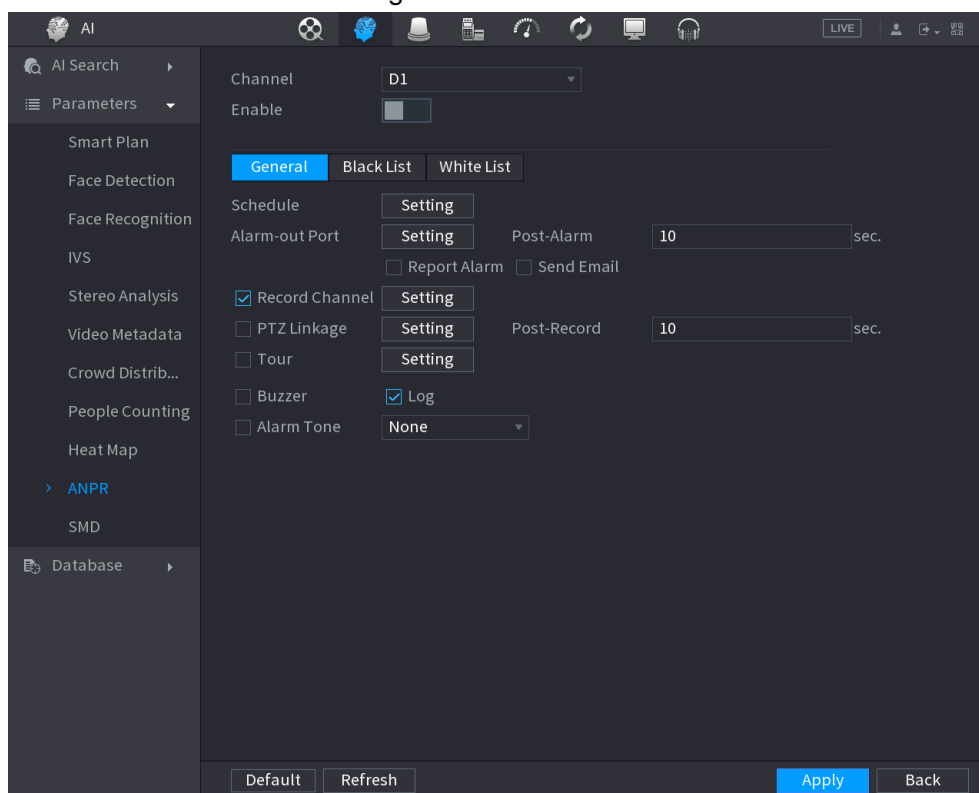

Step 2 Select the **Enable** check box to enable ANPR.

Step 3 Click **General** (default), **Blocklist** or **Allowlist** tab to configure it.







Before activate blocklist alarm or allowlist alarm, you need to add the corresponding plate information. Refer to "4.7.3.3 Block/Allow List" for detailed information.



- Regular: Device triggers an alarm when it detects any plate number.

- Blocklist: Device triggers an alarm when it detects plate number in the blocklist.
- Allowlist: Device triggers an alarm when it detects plate number in the allowlist.

Step 4 Set parameters. See Table 4-50.

Table 4-50

Parameter	Description
Period	Configure the period and in the set time range, the corresponding configuration item will be linked to start the alarm.
Alarm Out	The alarm device (such as lights, sirens, etc.) is connected to the alarm output port. When an alarm occurs, the NVR device transmits the alarm information to the alarm device.
Latch	When the alarm ends, the alarm extended for a period of time. The time range is from 0 seconds to 300 seconds.
Alarm Upload	<p>Select the check box. When an alarm occurs, the NVR device uploads an alarm signal to the network (including the alarm center).</p>  <ul style="list-style-type: none"> • This function is for some series products only. • You need to set the alarm center first. For details, see "4.11.14 Alarm Center".
Send Email	<p>Select the check box. When an alarm occurs, the NVR device sends an email to the set mailbox to notify the user.</p>  <p>You need to set the email first. For details, see "4.11.11 Email".</p>
Record Channel	<p>Select the check box and select the needed recording channel (support multiple choices). When an alarm occurs, the NVR device activates the channel for recording.</p>  <p>You need to enable intelligent recording and auto recording first. For details, see "4.1.4.6 Schedule".</p>
PTZ Activation	<p>Select the check box and click Setting to select the channel and PTZ action. When an alarm occurs, the NVR device associates the channel to perform the corresponding PTZ action. For example, activate the PTZ in channel one to turn to the preset point X.</p>  <ul style="list-style-type: none"> • Tripwire alarm supports to activate PTZ preset point only. • You need to set the corresponding PTZ actions first, see "4.4.4 Calling PTZ Functions".
Delay	At the end of the alarm, the recording extends for a period of time. The time range is from 10 seconds to 300 seconds.

Parameter	Description
Tour	<p>Select the check box and select the channel for tour. When an alarm occurs, the local interface of the NVR device displays the selected channel screen.</p>  <ul style="list-style-type: none"> You need to set the time interval and mode for tour first, see "4.16.2 Tour". After the tour is over, the preview interface is restored to the screen split mode before the tour.
Log	<p>Select the check box, the NVR device records the alarm information in the log when an alarm occurs.</p>
Voice Prompts	<p>Check the box and then select the corresponding audio file from the dropdown list. System plays the audio file when the alarm occurs.</p>  <p>Refer to "4.17.1 File Management" to add audio file first.</p>
Buzzer	<p>Select the check box to activate the buzzer when an alarm occurs.</p>

Step 5 Click **Apply**.

4.7.2.10 SMD

You can use SMD (Smart Motion Detection) to detect human and vehicle in the video, and store the detection result in structured storage for fast retrieval.

Procedure







Step 1 Select **Main Menu > AI > Parameter > SMD**.

Figure 4-165

Step 2 Select and enable a channel, and then configure parameters.

Table 4-51

Parameter	Description
Sensitivity	The higher the value is, the easier it is to trigger an alarm. But at the same time, the false alarm may occur. The default value is recommended.
Effective Target	Choose human or vehicle or both.
Schedule	Configure the period and in the set time range, the corresponding configuration item will be linked to start the alarm.
Anti-Dither	Indicates the time taken from the end of motion detection to the end of alarm linkage action. The range is 0 to 600 seconds.
Alarm-out Port	The alarm device (such as lights, sirens, etc.) is connected to the alarm output port. When an alarm occurs, the NVR device transmits the alarm information to the alarm device.
Post-Alarm	When the alarm ends, the alarm extended for a period of time. The time range is from 0 seconds to 300 seconds.
Show Message	Check box to enable a pop-up message in your local host PC.
Report Alarm	Select the check box. When an alarm occurs, the NVR device uploads an alarm signal to the network (including the alarm center).  <ul style="list-style-type: none"> This function is for some series products only. You need to set the alarm center first. For details, see "4.11.14 Alarm Center".

Parameter	Description
Send Email	<p>Select the check box. When an alarm occurs, the NVR device sends an email to the set mailbox to notify the user.</p>  <p>You need to set the email first. For details, see "4.11.11 Email".</p>
Record Channel	<p>Select the check box and select the needed recording channel (support multiple choices). When an alarm occurs, the NVR device activates the channel for recording.</p>  <p>You need to enable intelligent recording and auto recording first. For details, see "4.1.4.6 Schedule".</p>
Post-Record	<p>At the end of the alarm, the recording extends for a period of time. The time range is from 10 seconds to 300 seconds.</p>
PTZ Linkage	<p>Select the check box and click Setting to select the channel and PTZ action. When an alarm occurs, the NVR device associates the channel to perform the corresponding PTZ action. For example, activate the PTZ in channel one to turn to the preset point X.</p>  <ul style="list-style-type: none"> • Tripwire alarm supports to activate PTZ preset point only. • You need to set the corresponding PTZ actions first, see "4.4.4 Calling PTZ Functions".
Tour	<p>Select the check box and select the channel for tour. When an alarm occurs, the local interface of the NVR device displays the selected channel screen.</p>  <ul style="list-style-type: none"> • You need to set the time interval and mode for tour first, see "4.16.2 Tour". • After the tour is over, the preview interface is restored to the screen split mode before the tour.
Picture Storage	<p>Select the Snapshot check box to take a snapshot of the selected channel.</p>  <p>To use this function, select Main Menu > CAMERA > Encode > Snapshot, select Event in Type list.</p>
Buzzer	<p>Select the check box to activate the buzzer when an alarm occurs.</p>
Alarm Tone	<p>Check the box and then select the corresponding audio file from the drop-down list. System plays the audio file when the alarm occurs.</p>  <p>Refer to "4.17.1 File Management" to add audio file first.</p>

Step 3 Click **Apply**.

4.7.2.11 Master-slave Tracking

Master-slave tracking refers to fisheye camera and speed dome linkage system. The fisheye cameras serves as the main camera and captures panoramic videos; and the speed dome serves as the slave camera and captures details of the video.

Prerequisites

- The monitoring areas of fisheye camera and speed dome should be the same area.
- Fisheye camera and speed dome should be added through private protocol.



This function is for select models only.

Procedure

Step 1 Select **Main Menu > AI > Parameters > Master-Slave Tracking**.

Figure 4-166

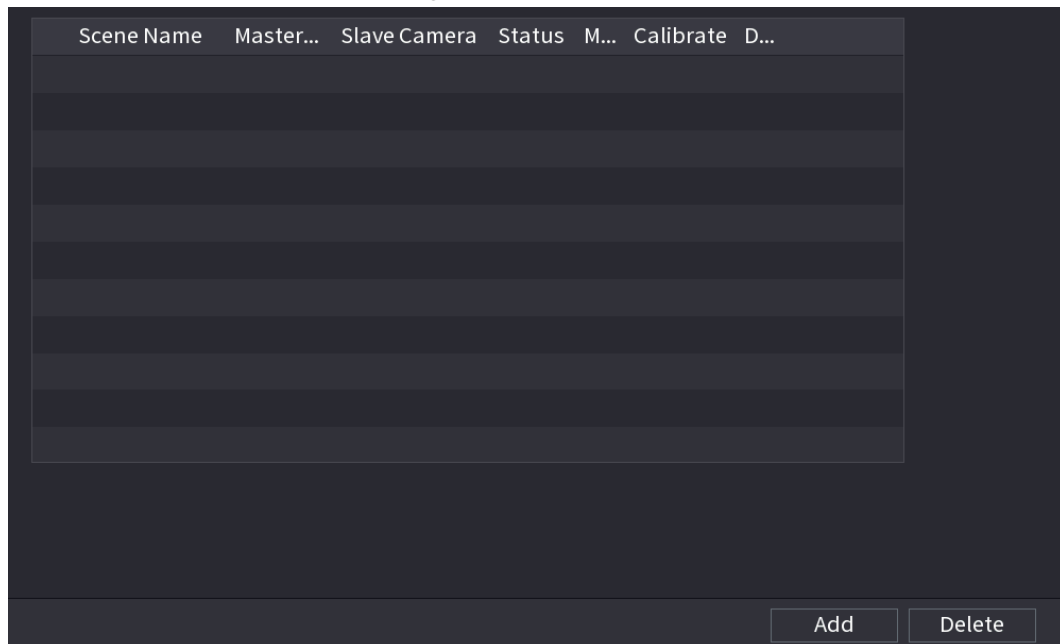

Step 2 Add monitoring area.

- 1) Click **Add**.

Figure 4-167

2) Configure parameters.

Table 4-52

Parameter	Description
Type	Fisheye + PTZ: <ul style="list-style-type: none"> • 1 Fisheye + 1 PTZ • 1 Fisheye + 2 PTZ • 1 Fisheye + 3 PTZ
Scene Name	This parameter is user defined.
Master Camera	Select a fisheye camera as needed. <ol style="list-style-type: none"> 1. Click Select in Master Camera line. 2. Select a fisheye camera in the prompted dialog box. 3. Click Apply.
Slave Camera	Select speed domes as needed. <ol style="list-style-type: none"> 1. Click Select in Master Camera line. 2. Select speed domes in the prompted dialog box. 3. Click Apply.

Step 3 Click **Apply**.

The monitoring area is successfully added.

Figure 4-168

Scene Name	Master...	Slave Camera	Status	M...	Calibrate	D...
Scene 1	Scene 1	Scene 1				

Step 4 Configure calibration points to set the binding relationship of fisheye camera and speed dome.



Set a distant place as the first calibration point to improve accuracy.

1) Click or double-click the target scene.

2) Click the target place on the video of fisheye camera, or move to the target place.



The video at upper-left corner is the fisheye camera screen, and the video at upper-right corner is the speed dome screen.

Figure 4-169

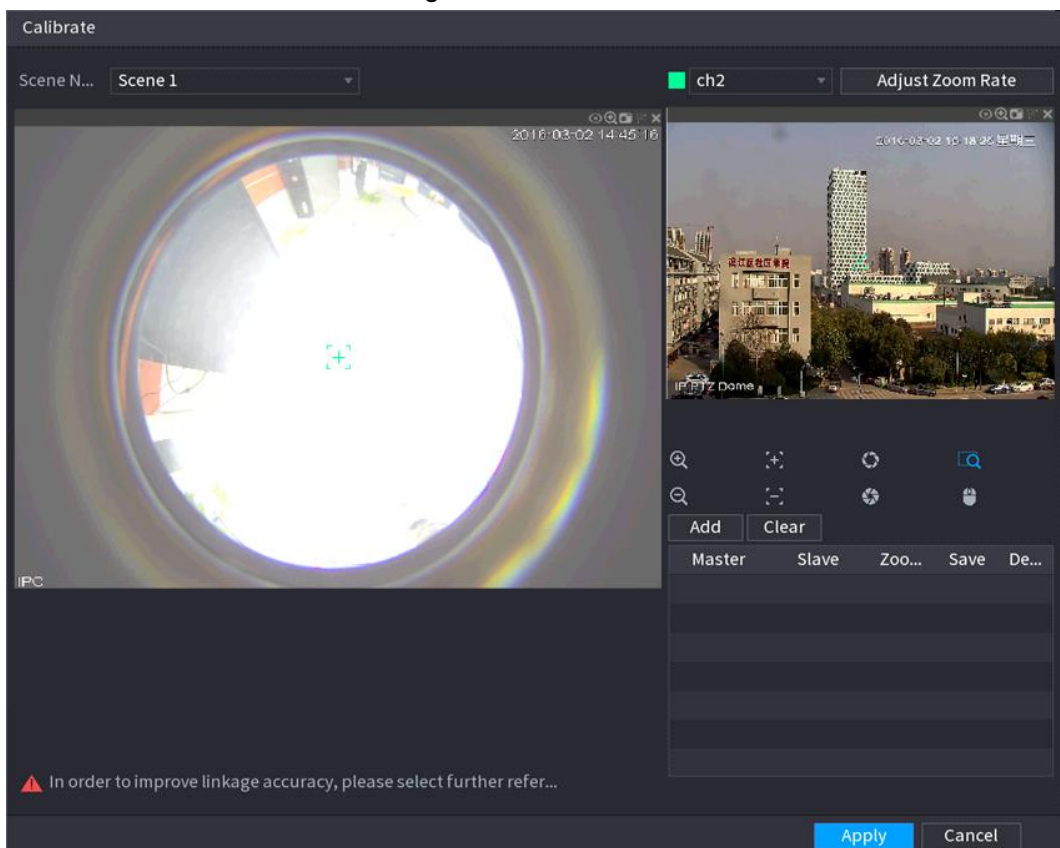

3) Adjust position through the icons below the speed dome screen to make the center of speed dome identical to the of fisheye camera.

The on the speed dome screen is the center of speed dome.

Table 4-53

Icon	Description
	Zoom in/zoom out.
	Adjust resolution.
	Adjust height.
	Electronic mouse. You can use this icon to move the mouse to control PTZ direction.
	Quick positioning key. Click this icon to select a place, and the screen will be focused and centered on the selected place.

4) Click **Add**.

The calibration point will be displayed in the list at lower-right corner.

Figure 4-170

Master	Slave	Zoo...	Save	De...
4090,4096				
6194,6716				
2462,2208				
7367,2425				

Step 5 Click to save the newly added calibration point.

Step 6 Repeat Step 2 to Step 5 to add more calibration points.



Set 3–8 calibration points for a speed dome.

Step 7 Click **Apply**.

4.7.2.12 Video Quality Analytics

Background Information

When conditions such as blurry, overexposure, or the color changes appear on the screen, the system activates the alarm.



- This function takes effect only when the remote IPC supports video quality analytics.
- This function is for select models only.

Procedure

Step 1 Select **Main Menu > AI > Parameters > Video Quality Analytics**.

Step 2 Select a channel and click **Enable**.

Figure 4-171

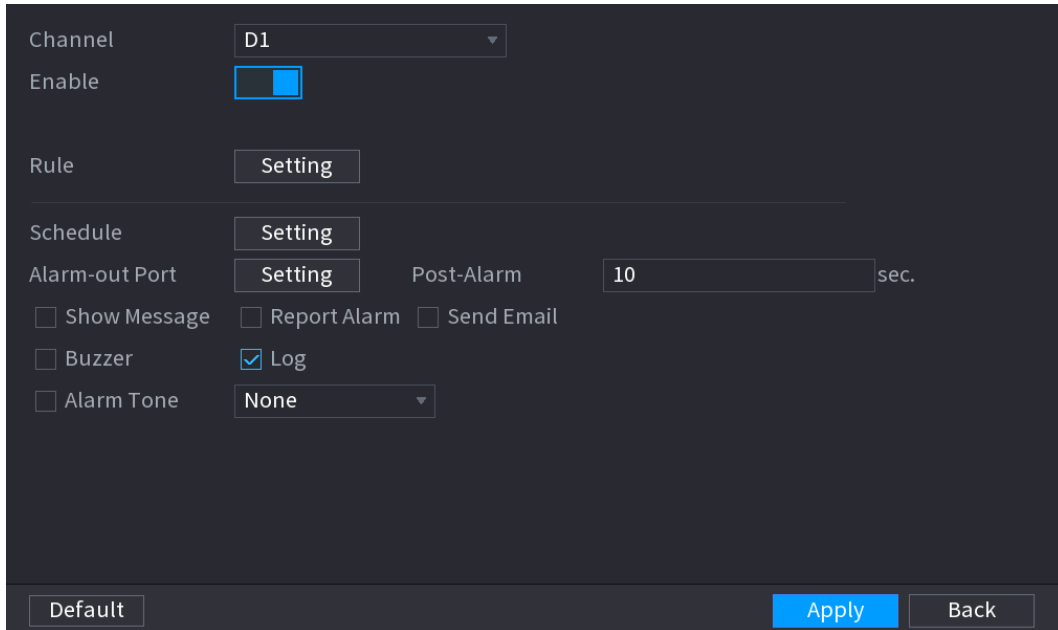

Channel: D1

Enable:

Rule: Setting

Schedule: Setting

Alarm-out Port: Setting Post-Alarm: 10 sec.

Show Message Report Alarm Send Email

Buzzer Log

Alarm Tone: None

Default Apply Back

Step 3 Click **Setting** next to **Rule**.

Step 4 Select items and set thresholds as needed .

Figure 4-172

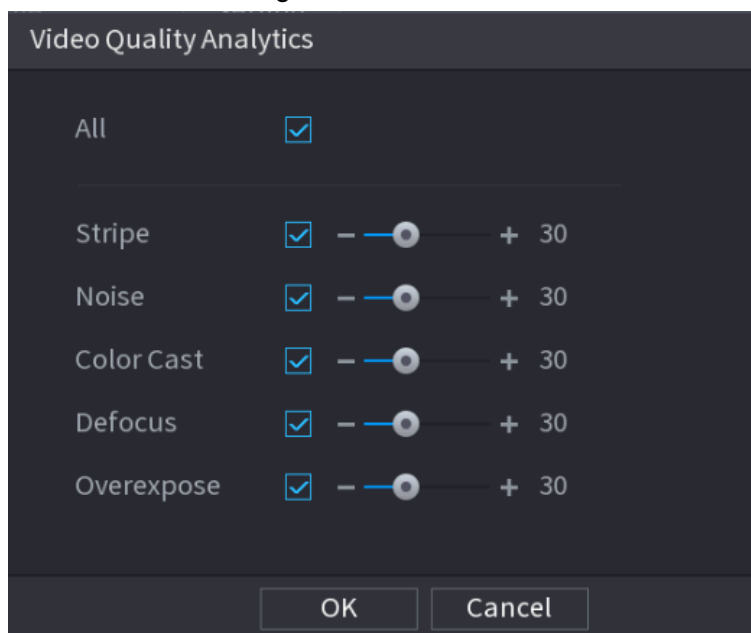

The value range of threshold is 0–100, and the default value is 30. When the value exceeds the set threshold, an alarm will be triggered.



Parameter	Description
Stripe	Stripes refer to the striped interferences in the video which might be due to device aging or signal interference, such as horizontal, vertical, or oblique stripes.
Noise	Video noise can be defined as the distortion of optical system or the degradation of image quality caused by hardware equipment during transmission.
Color Cast	An image in the video is generally a colorful image that contains color information, such as RGB. When these three components appear at some unusual scale in an image, the image is biased.
Defocus	An image with high resolution contains more details, but image blur is a common problem of image quality decrease which is caused by many factors in the process of image acquisition, transmission and processing, and is defined as virtual focus in video diagnosis.
Overexpose	The brightness of the image refers to the intensity of the image pixels. Black is the darkest and white is the brightest. Black is represented by 0 and white is represented by 255. When the brightness value exceeds the threshold, the image is over exposed.

Step 5 Click **Apply**.

Step 6 Set alarm linkage parameters.

Table 4-54

Parameter	Description
Period	Configure the period and in the set time range, the corresponding configuration item will be linked to start the alarm.

Parameter	Description
Alarm Out	The alarm device (such as lights, sirens, etc.) is connected to the alarm output port. When an alarm occurs, the NVR device transmits the alarm information to the alarm device.
Latch	When the alarm ends, the alarm is extended for a period of time. The time range is from 0 seconds to 300 seconds.
Alarm Upload	<p>Select the check box. When an alarm occurs, the NVR uploads an alarm signal to the network (including the alarm center).</p>  <ul style="list-style-type: none"> • This function is for some series products only. • You need to set the alarm center first. For details, see "4.11.14 Alarm Center".
Send Email	<p>Select the check box. When an alarm occurs, the NVR device sends an email to the set mailbox to notify the user.</p>  <p>You need to set the email first. For details, see "4.11.11 Email".</p>
Log	Select the check box, the NVR device records the alarm information in the log when an alarm occurs.
Voice Prompts	<p>Check the box and then select the corresponding audio file from the drop-down list. System plays the audio file when the alarm occurs.</p>  <p>Refer to "4.17.1 File Management" to add audio file first.</p>
Buzzer	Select the check box to activate the buzzer when an alarm occurs.

Step 7 Click **Apply**.

4.7.3 Database

After you successfully set the face library, the detected human face can compare with the image on the face library. The face library settings include create face library, add human face and human face modeling.



For privacy reason, the human face is pixelated.

4.7.3.1 Creating Face Database

Procedure

- Step 1 Select **Main Menu > AI > Database > Face Database Config**.
The **Face Database Config** interface is displayed. See Figure 4-173.

Figure 4-173

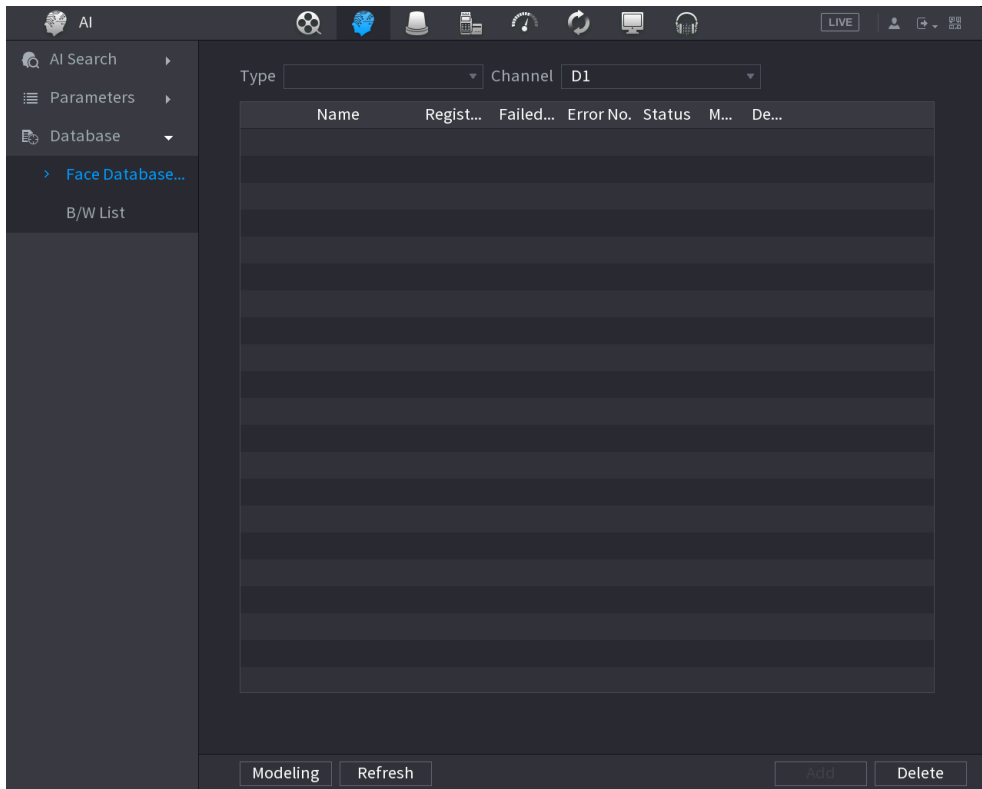

Step 2 Select a channel and then click **Add**.

Figure 4-174

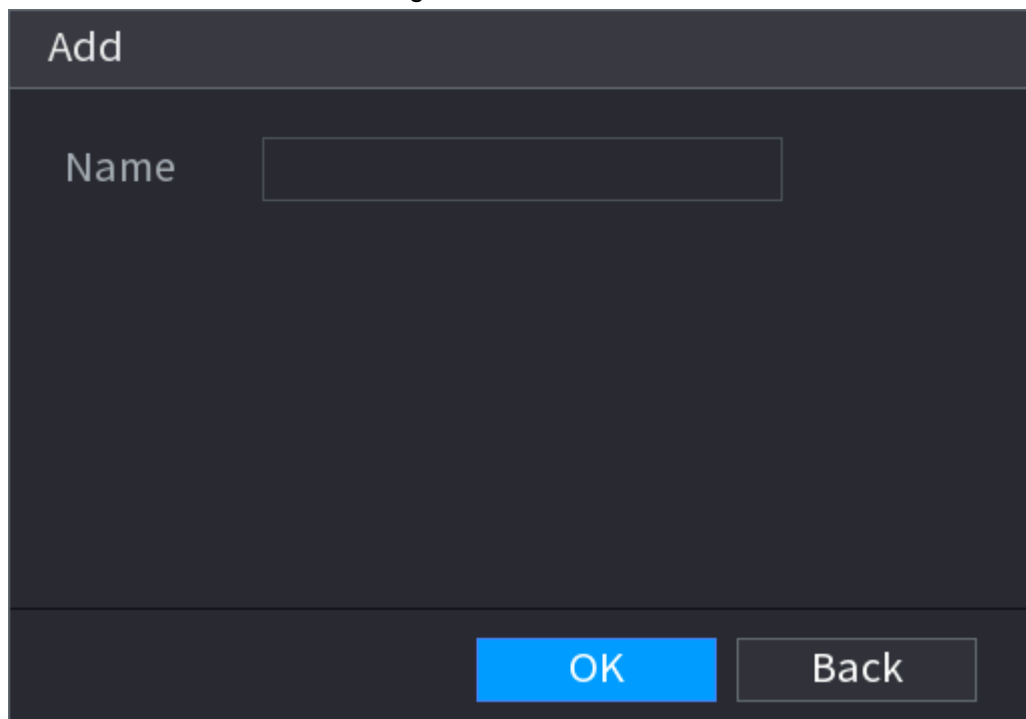

Step 3 Enter human face database name and then click **OK**.
System successfully saves the face library.

4.7.3.1.1 Adding Face Pictures

You can add face pictures to the existing libraries one by one or by batch, or add from the

detected faces.



- To add face pictures one by one or by batch, you need to get the pictures from the USB storage device. The picture size should be smaller than 256K with resolution between 200×200–6000×5000.
- The picture resolution for NVR2-I series should be less than or equal to 1920×1080.

4.7.3.1.2 Adding One Face Picture

Background Information

You can add one face picture to the database. It is for the scenario that the registered human face picture amount is small.

Procedure

- Step 1** Select **Main Menu > AI > Database > Face Database Config**
The **Face Database Config** interface is displayed.
- Step 2** Click  of the library that you want to configure.
The **Details** interface is displayed. See Figure 4-175.

Figure 4-175



- Step 3** Click **Register**.
The **Register** interface is displayed. See Figure 4-176.

Figure 4-176

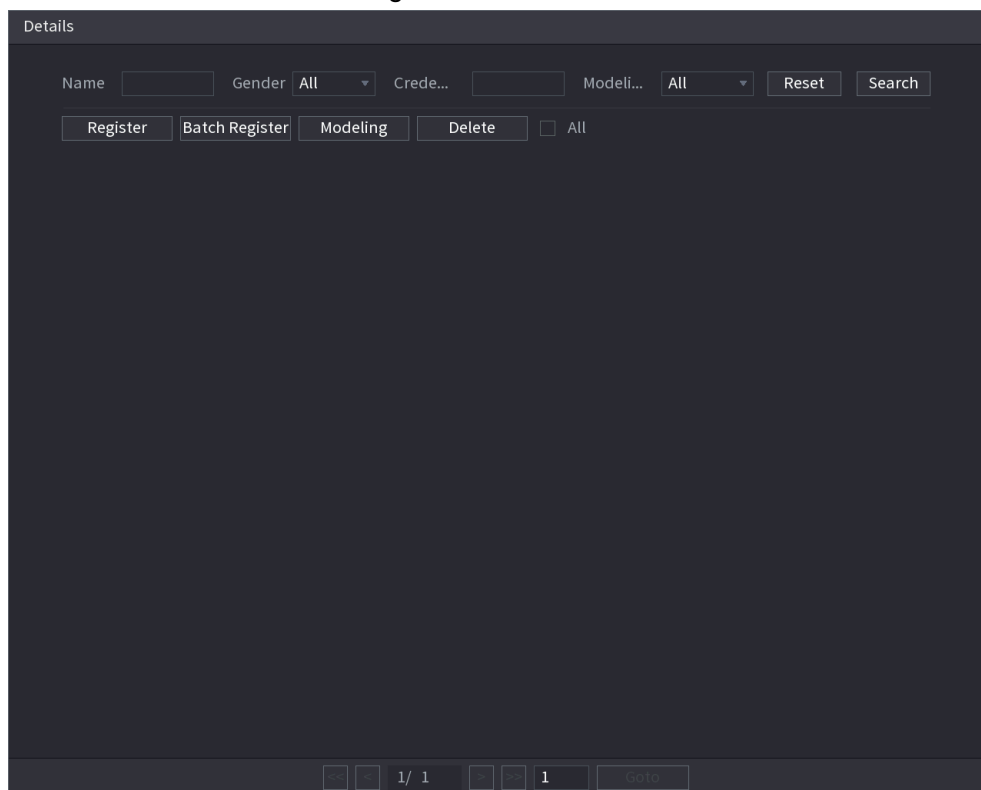
- Step 4** Click to add a face picture.
The Browse interface is displayed. See Figure 4-177.

Figure 4-177

- Step 5** Select a face picture and enter the registration information. See Figure 4-178.

Figure 4-178

Register

Name

Gender Male Female

Birthday

Address

Credenti...

Credenti...

Country

Step 6 Click **OK**.

The system prompts the registration is successful.

Step 7 On the **Details** interface, click **Search**.

The system prompts modeling is successful. See Figure 4-179.



If the system prompts the message indicating modeling is in process, wait a while and then click Search again. If modeling is failed, the registered face picture cannot be used for face recognition.

Figure 4-179

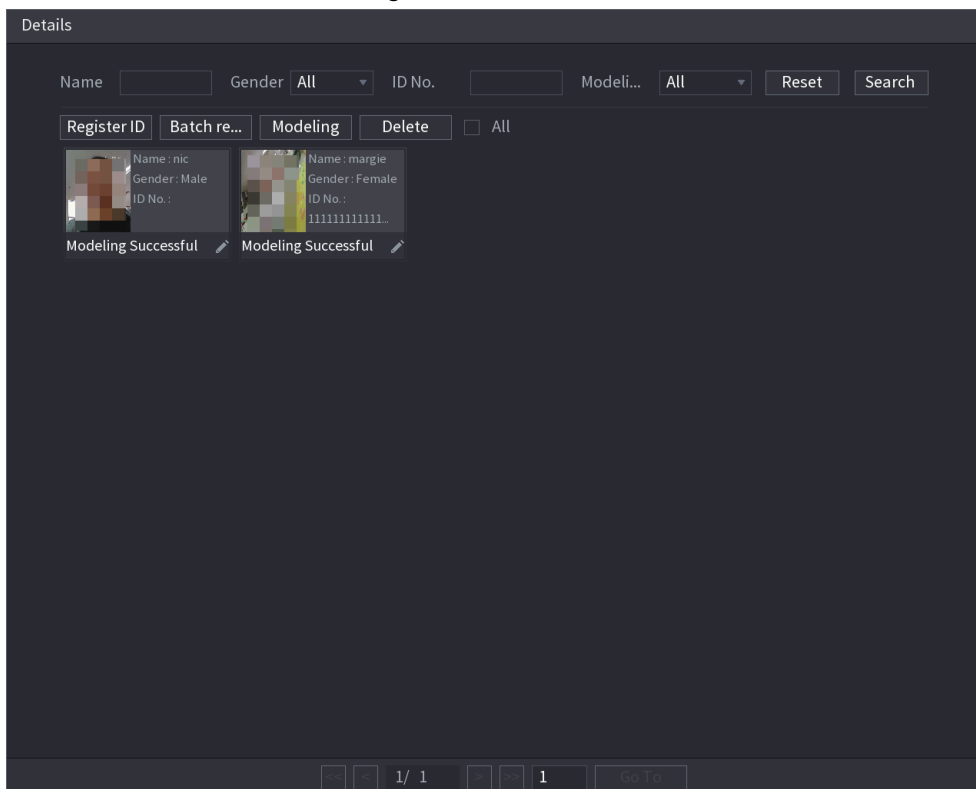

4.7.3.1.3 Adding Face Pictures in Batches

Background Information

System supports batch add if you want to import several human face image at the same time.

Procedure

Step 1 Give a name to the face picture by referring to the following table. See Table 4-55.

Table 4-55

Naming format	Description
Name	Enter the name.
Gender	Enter 1 or 2. 1 represents male, and 2 represents female.
Birthday	Enter numbers in the format of yyyy-mm-dd.
Country	Enter the abbreviation of country. For example, CN for China.
ID Type	1 represents ID card; 2 represents passport; 3 represents military officer password.
ID No.	Enter the ID number.
Address	Enter the address.

Step 2 Select **Main Menu > AI > Database > Face Database Config.**

- The **Face Database Config** interface is displayed.
- Step 3 Click  of the library that you want to configure.
The **Details** interface is displayed. See Figure 4-175.
- Step 4 On the **Details** interface, click **Batch Register**.
The Batch register interface is displayed. See Figure 4-180.

Figure 4-180



- Step 5 Click **Select pictures, maximum 256 each time** or **Select a Folder** to import face pictures.
- Step 6 Click **OK** to complete batch registration.

4.7.3.2 Exporting/Importing Face Database

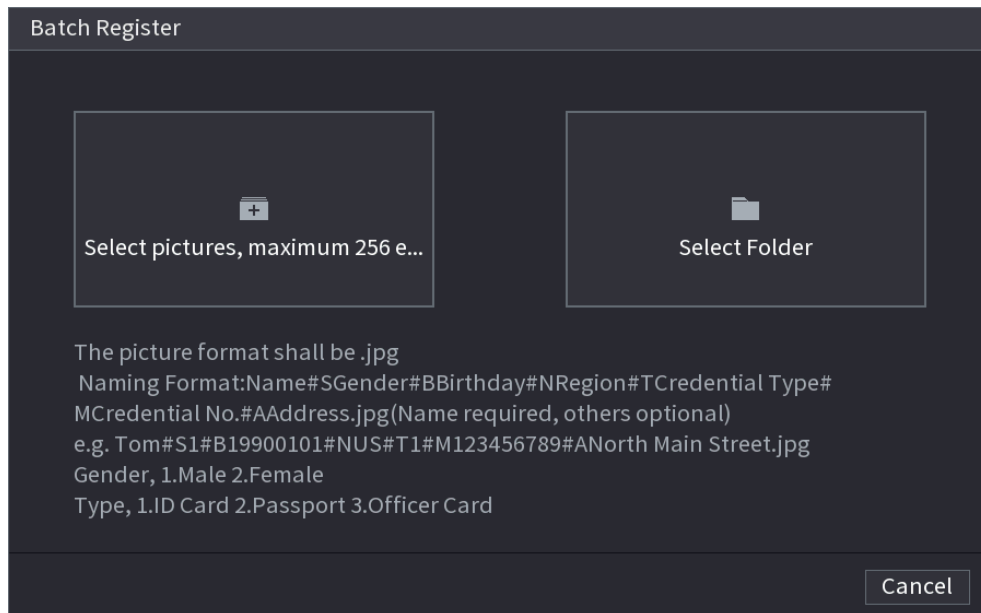
You can export and import local face database.

4.7.3.2.1 Exporting Face Database

Procedure

- Step 1 Select **Main Menu > AI > Database > Face Database Config**.
- Step 2 Select one or several face databases, and then click **Export**.
- Step 3 Set address and password.



- Password is required; otherwise the imported database cannot be saved.
- The address switches to /NVR/Facelib/ automatically if this directory is not changed.

Figure 4-181 Export

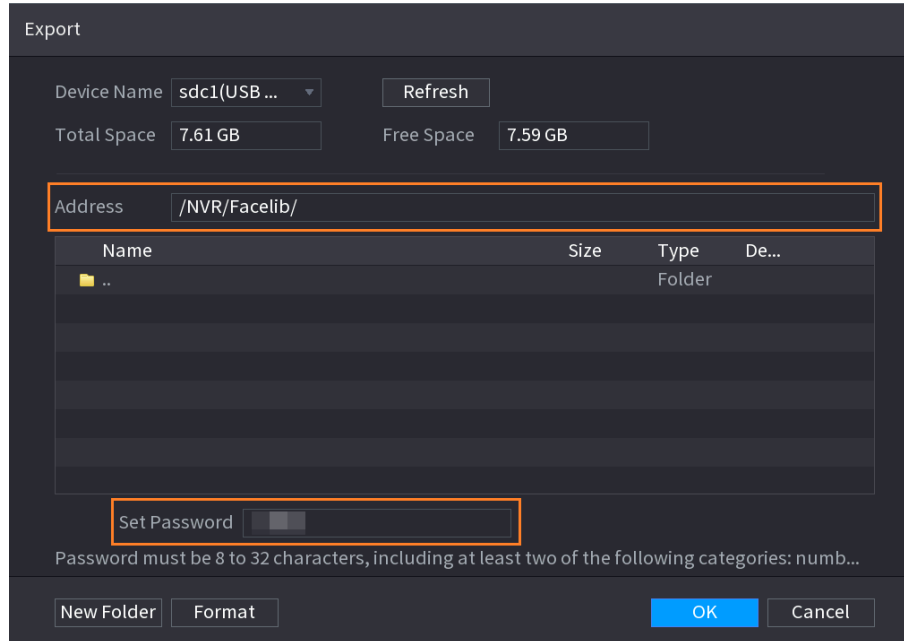

Step 4 Click **OK** to start exporting face database, and you can view the progress on the exporting interface.

Figure 4-182 Export progress

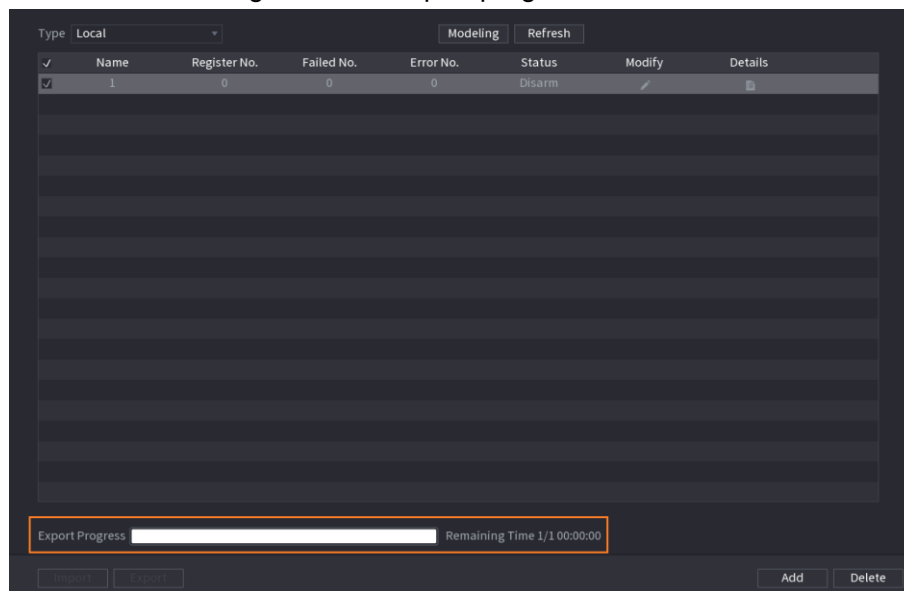

4.7.3.2.2 Importing Face Database

Procedure

- Step 1** Select **Main Menu > AI > Database > Face Database Config**
- Step 2** Click **Import**.
- Step 3** Set address and password.



- Password is required and must be the same with password for export; otherwise the imported database cannot be saved.
- The address switches to /NVR/Facelib/ automatically if this directory is not changed.

Step 4 Click **OK** to start importing face database, and you can view the progress on the importing interface.

4.7.3.3 Block/Allow List

To manage vehicle management, you can add the corresponding plate number on the blacklist or allowlist. System can compare the detected plate information with the plate on the blacklist/allowlist and then trigger the corresponding alarm linkage.

After enable block/allowlist, on the preview interface, the plate in the blacklist is displayed as red on the plate list, the plate in the allowlist is displayed as green on the plate list. For the plate not in the block/allowlist, the plate is displayed as white.

4.7.3.3.1 Adding B/W List

Procedure

- Step 1** Select **Main Menu > AI > Database > B/W List**.
The **B/W List** interface is displayed. See Figure 4-183.

Figure 4-183

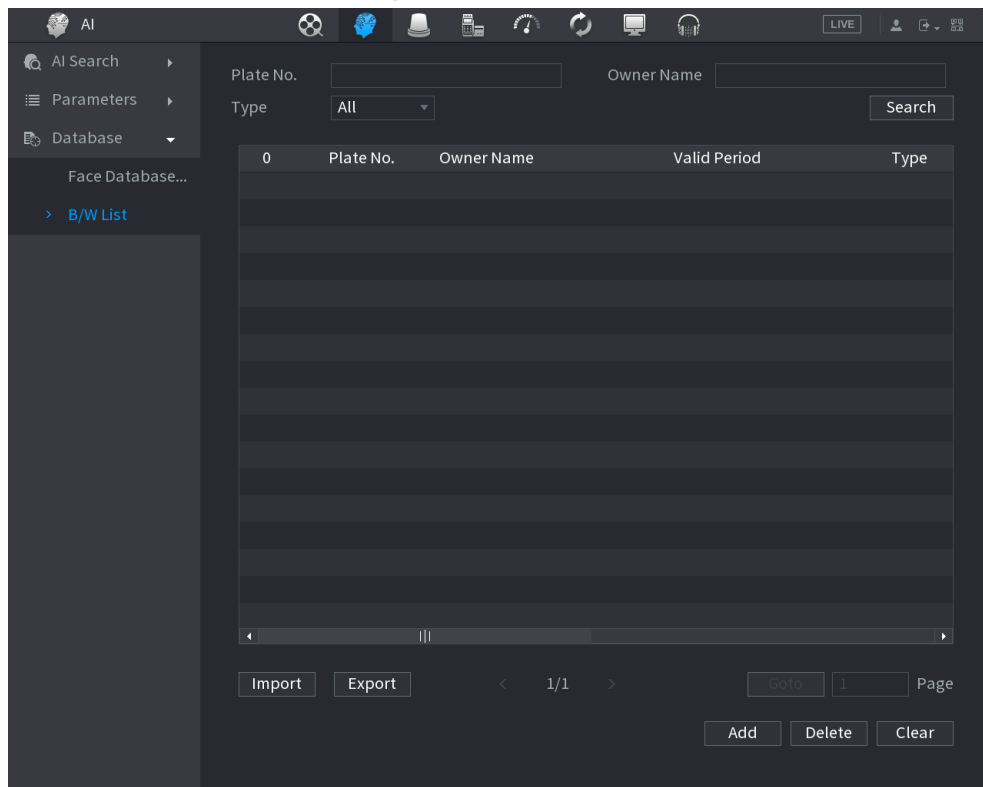

- Step 2** Set plate information such as plate number, car owner name, and then select **Black List** or **White List**.

Step 3 Click **Add**.



The change of black list/white list configurations on NVR will be synchronized to ITC that supports black list/white list function.

4.7.3.3.2 Deleting Black/White List

Set type as **White List**, **Black List**, or **All**, and then click **Search**. System displays block/allowlist information. See Figure 4-184.

- On the searched results list, check the box before the plate number and then click **Delete**, or click the  of the corresponding plate number, you can delete the plate information on the black/white list.
- Click **Clear** to delete all plate information on the black/white list.



The change of black list/white list configurations on NVR will be synchronized to ITC that supports black list/white list function.

Figure 4-184

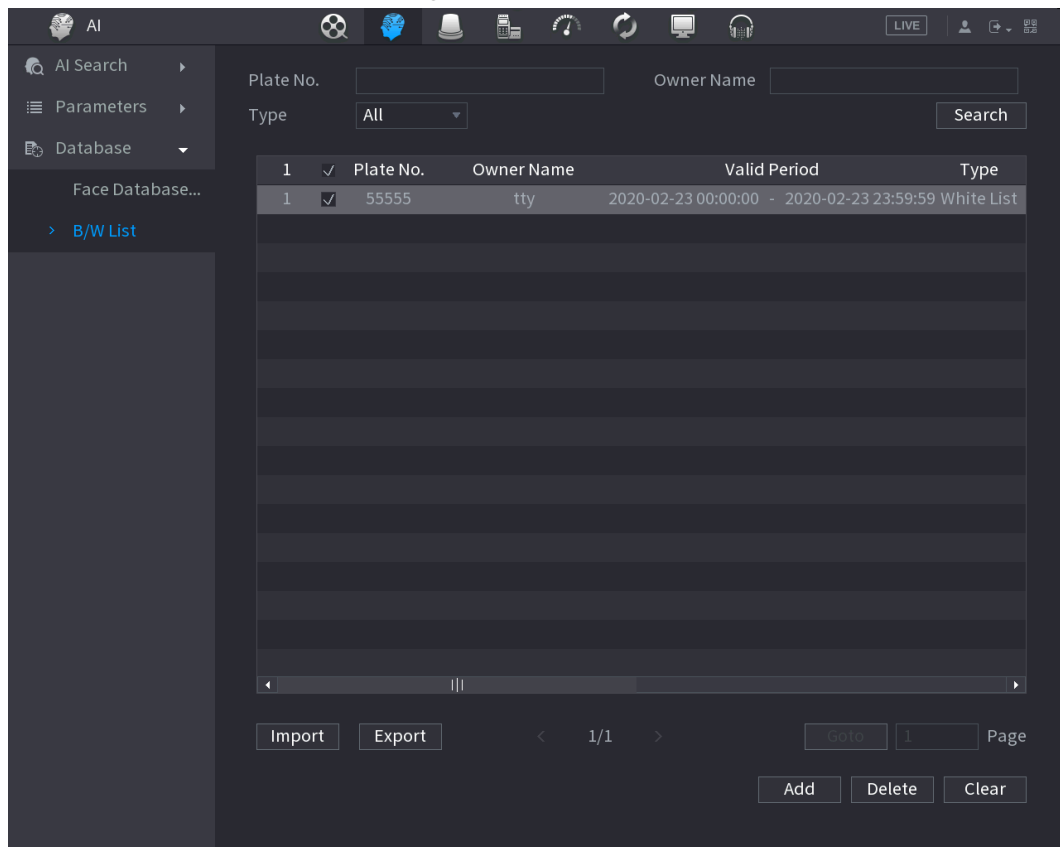

4.7.3.3.3 Import/Export Black/allowlist

System supports export block/allowlist to the USB device, or import block/allowlist from the USB device. System supports .csv or .xlsx file. The export file format is .csv.

- Import block/allowlist: Click **Import** and then select the corresponding file, click **Browse** to import the file.
- Export block/allowlist: Click **Export** and then select the file storage path and then click **Save**.

4.8 Event Manager

4.8.1 Alarm Info

Background Information

You can search, view and back up the alarm information.

Procedure

Step 1 Select **Main Menu > ALARM > Alarm Info**.

The **Alarm Info** interface is displayed. See Figure 4-185.

Figure 4-185

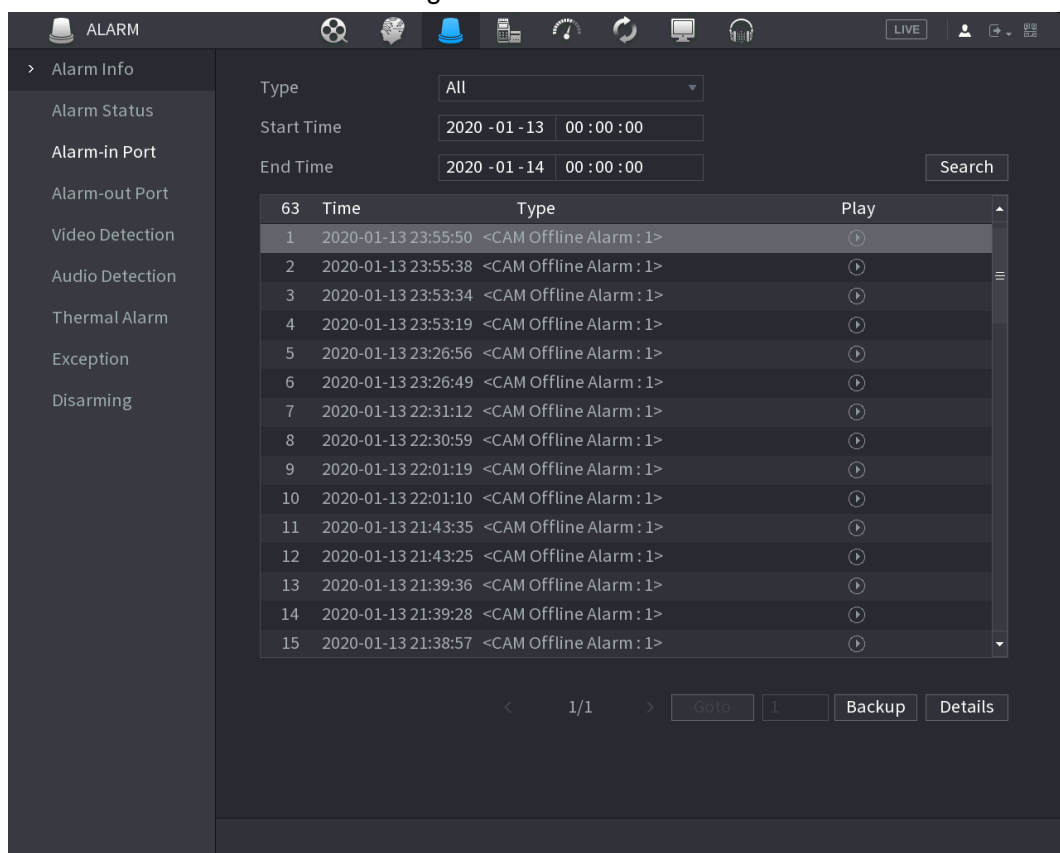

Step 2 In the **Type** list, select the event type; In the **Start Time** box and **End Time** box, enter the specific time.

Step 3 Click **Search**.

The search results are displayed.

Step 4 Click **Backup** to back up the search results into the external storage device.



- Select an alarm event log and then click Backup to back up it to peripheral USB device.
- Select an alarm event log, click  to play the recorded video of alarm event. Double-click a log or click Details to view the detailed information of the event.

4.8.2 Alarm Status

You can view NVR alarm event, and remote channel alarm event.

Select **Main Menu > ALARM > Alarm Status**, the **Alarm Status** interface is displayed. See Figure 4-186.

Figure 4-186

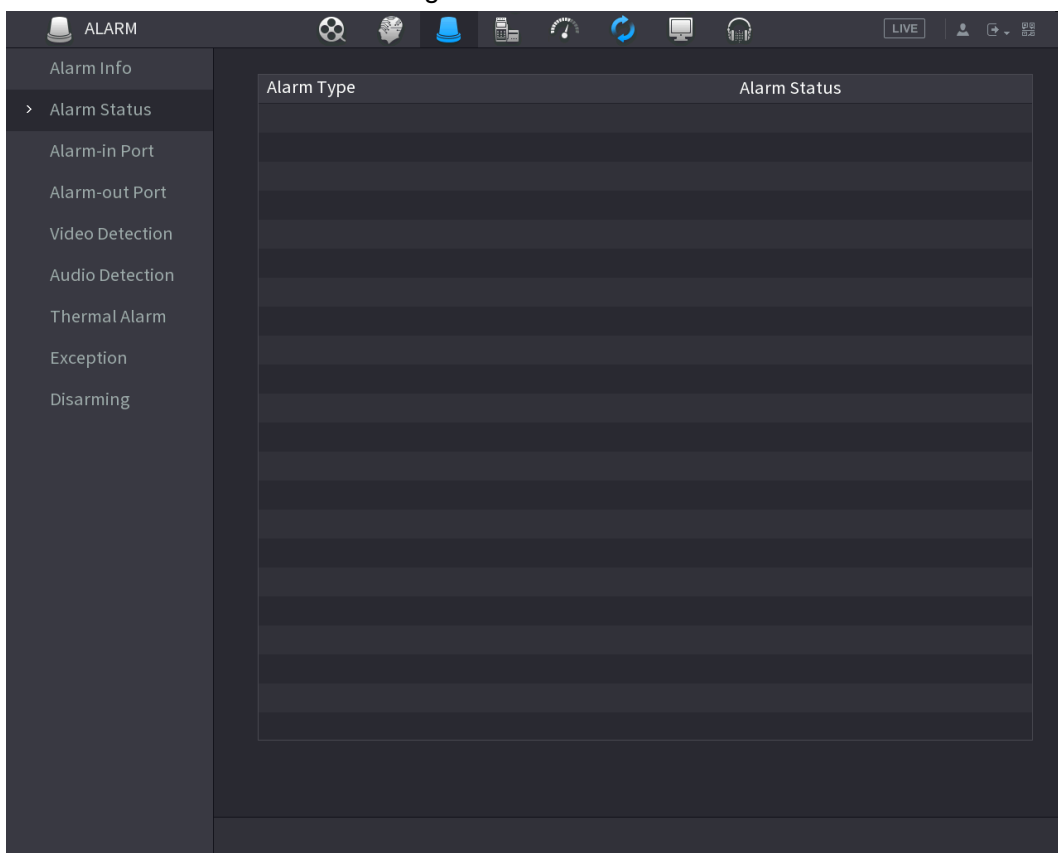

4.8.3 Alarm Input

Procedure

Step 1 Select **Main menu > ALARM > Alarm-in Port**.

The **Alarm-in Port** interface is displayed. See Figure 4-187.

Step 2 There are four alarm types.

- Local alarm: After connect the alarm device to the NVR alarm input port, system can trigger the corresponding alarm operations when there is alarm signal from the alarm input port to the NVR.
- Network alarm: NVR trigger corresponding alarm operations when it receives the alarm signal via the network transmission.

- IPC external alarm: When the network camera connected peripheral device has triggered an alarm, it can upload the alarm signal to the NVR via the network transmission. The system can trigger the corresponding alarm operations.
- IPC offline alarm: When the network connection between the NVR and the network camera is off, the system can trigger the corresponding alarm operations.

Figure 4-187

The screenshot shows the 'ALARM' configuration page with the 'Local' tab selected. The left sidebar lists various alarm types, with 'Alarm-in Port' expanded. The main area contains the following settings:

- Alarm-in Port:** 1
- Enable:**
- Alarm Name:** Alarm-in Port1
- Device Type:** NO
- Schedule:** Setting
- Alarm-out Port:** Setting
- Anti-Dither:** 5 sec.
- Post-Alarm:** 10 sec.
- Show Message
- Report Alarm
- Send Email
- Record Channel
- Post-Record:** 10 sec.
- PTZ Linkage
- Setting**
- Tour
- Setting**
- Buzzer
- Log
- Picture Storage
- Setting**
- Alarm Tone
- None







Buttons at the bottom include 'Default', 'Copy to', 'Apply', and 'Back'.

Step 3 Set **Alarm-in Port** channel number and then select the Enable check box to enable the function.

Step 4 Configure parameters. See Table 4-56.

Table 4-56

Parameter	Description
Alarm-in Port	Select a channel to set alarm.
Enable	Check the box <input checked="" type="checkbox"/> to enable the function.
Alarm Name	Enter an alarm name.
Device Type	NO (normal open) or NC (normal close).
Schedule	Define a period during which the alarm is active. For details, see "4.8.5.1 Motion Detection".
Alarm-out Port	The alarm device (such as lights, sirens, etc.) is connected to the alarm output port. When an alarm occurs, the NVR device transmits the alarm information to the alarm device.
Post-Alarm	When the alarm ends, the alarm extended for a period of time. The time range is from 0 seconds to 300 seconds.
Show Message	Check box to enable a pop-up message in your local host PC.

Parameter	Description
Report Alarm	<p>Select the check box. When an alarm occurs, the NVR device uploads an alarm signal to the network (including the alarm center).</p>  <ul style="list-style-type: none"> This function is for some series products only. You need to set the alarm center first. For details, see "4.11.14 Alarm Center".
Send Email	<p>Select the check box. When an alarm occurs, the NVR device sends an email to the set mailbox to notify the user.</p>  <p>You need to set the email first. For details, see "4.11.11 Email".</p>
Record Channel	<p>Select the check box and select the needed recording channel (support multiple choices). When an alarm occurs, the NVR device activates the channel for recording.</p>  <p>You need to enable intelligent recording and auto recording first. For details, see "4.1.4.6 Schedule".</p>
PTZ Linkage	<p>Select the check box and click Setting to select the channel and PTZ action. When an alarm occurs, the NVR device associates the channel to perform the corresponding PTZ action. For example, activate the PTZ in channel one to turn to the preset point X.</p>  <ul style="list-style-type: none"> Tripwire alarm supports to activate PTZ preset point only. You need to set the corresponding PTZ actions first, see "4.4.4 Calling PTZ Functions".
Post Record	<p>At the end of the alarm, the recording extends for a period of time. The time range is from 10 seconds to 300 seconds.</p>
Tour	<p>Select the check box and select the channel for tour. When an alarm occurs, the local interface of the NVR device displays the selected channel screen.</p>  <ul style="list-style-type: none"> You need to set the time interval and mode for tour first, see "4.16.2 Tour". After the tour is over, the preview interface is restored to the screen split mode before the tour.
Picture Storage	<p>Select the Picture Storage check box to take a snapshot of the selected channel.</p>  <p>To use this function, select Main Menu > Camera > Encode > Snapshot, and then select Event (Trigger) in Type list.</p>
Log	<p>Select the check box, the NVR device records the alarm information in the log when an alarm occurs.</p>

Parameter	Description
Alarm Tone	Check the box and then select the corresponding audio file from the drop-down list. System plays the audio file when the alarm occurs.  Refer to "4.17.1 File Management" to add audio file first.
Buzzer	Select the check box to activate the buzzer when an alarm occurs.

Step 5 Click **Apply**.

4.8.4 Alarm Control

Background Information

You can set proper alarm output (Auto/manual/off). Connect the alarm device to the system alarm output port, and set the mode as auto, system can trigger the corresponding operations when an alarm occurs.

- Auto: Once an alarm event occurs, system can generate an alarm.
- Manual: Alarm device is always on the alarming mode.
- Off: Disable alarm output function.

Procedure

Step 1 Select **Main menu > ALARM > Alarm-out Port**.

The **Alarm-out Port** interface is displayed. See Figure 4-188.

Figure 4-188

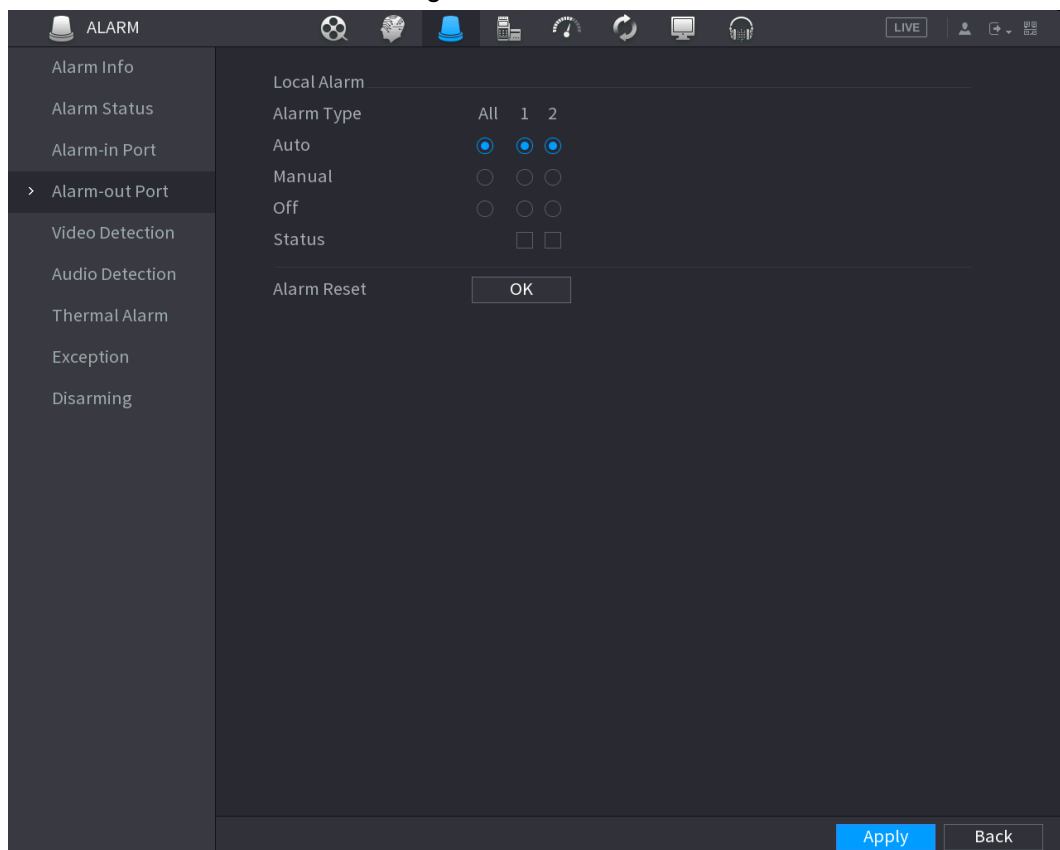

Step 2 Select the alarm mode of the alarm output channel.

- Click **OK** in **1Alarm Reset** area, you can clear all alarm output statuses.

- View the alarm output status on the **Status** column.

Step 3 Click **Apply**.

4.8.5 Video Detection

The video detection adopts the computer image and graphics process technology. It can analyze the video and check there is considerable changing or not. Once video has changed considerably (such as there is any moving object, video is distorted), system can trigger the corresponding alarm activation operations.

Select **Main menu > ALARM > Video Detection > Motion Detection**, you can see motion detect interface. There are five detection types: motion detection, video loss, tampering, scene changing and PIR alarm.

4.8.5.1 Motion Detection

Background Information

When the moving object appears and moves fast enough to reach the preset sensitivity value, the system activates the alarm.

Procedure

Step 1 Select **Main menu > ALARM > Video Detection > Motion Detection**.



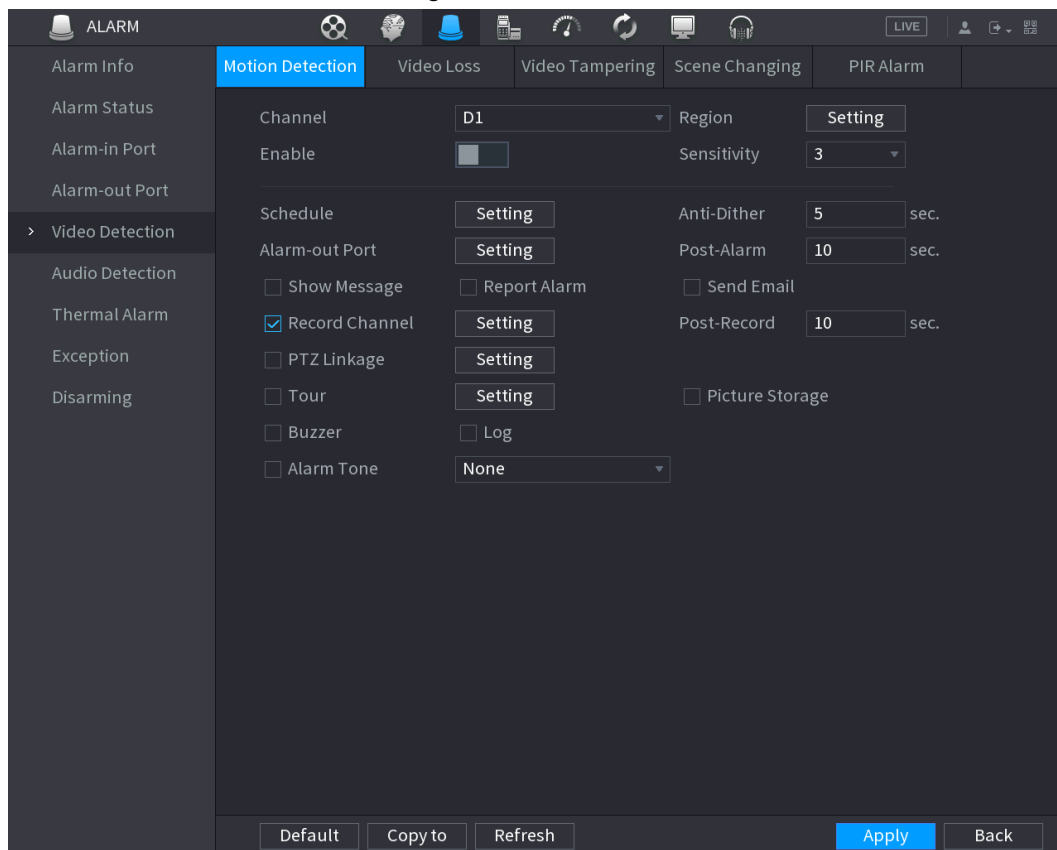

The **Motion Detection** interface is displayed. See Figure 4-189.



Figure 4-189



Step 2 Configure the settings for the motion detection parameters. See Table 4-57.

Table 4-57

Parameter	Description
Channel	In the Channel list, select a channel to set the motion detection.
Region	Click Setting to define the motion detection region.
Enable	Enable or disable the motion detection function. Check the box  to enable the function.
Sensitivity	The higher the value is, the easier it is to trigger an alarm. But at the same time, the false alarm may occur. The default value is recommended.
Schedule	Define a period during which the motion detection is active.
Anti-Dither	Indicates the time taken from the end of motion detection to the end of alarm linkage action. The range is 0 to 600 seconds.
Alarm-out Port	The alarm device (such as lights, sirens, etc.) is connected to the alarm output port. When an alarm occurs, the NVR device transmits the alarm information to the alarm device.
Post-Alarm	When the alarm ends, the alarm extended for a period of time. The time range is from 0 seconds to 300 seconds.
Show Message	Check box to enable a pop-up message in your local host PC.
Report Alarm	<p>Select the check box. When an alarm occurs, the NVR device uploads an alarm signal to the network (including the alarm center).</p> <p></p> <ul style="list-style-type: none"> • This function is for some series products only. • You need to set the alarm center first. For details, see "4.11.14 Alarm Center".
Send Email	<p>Select the check box. When an alarm occurs, the NVR device sends an email to the set mailbox to notify the user.</p> <p></p> <p>You need to set the email first. For details, see "4.11.11 Email".</p>
Record Channel	<p>Select the check box and select the needed recording channel (support multiple choices). When an alarm occurs, the NVR device activates the channel for recording.</p> <p></p> <p>You need to enable intelligent recording and auto recording first. For details, see "4.1.4.6 Schedule".</p>
Post-Record	At the end of the alarm, the recording extends for a period of time. The time range is from 10 seconds to 300 seconds.
PTZ Linkage	<p>Select the check box and click Setting to select the channel and PTZ action. When an alarm occurs, the NVR device associates the channel to perform the corresponding PTZ action. For example, activate the PTZ in channel one to turn to the preset point X.</p> <p></p> <ul style="list-style-type: none"> • Tripwire alarm supports to activate PTZ preset point only. • You need to set the corresponding PTZ actions first, see "4.4.4 Calling PTZ Functions".

Parameter	Description
Tour	<p>Select the check box and select the channel for tour. When an alarm occurs, the local interface of the NVR device displays the selected channel screen.</p>  <ul style="list-style-type: none"> You need to set the time interval and mode for tour first, see "4.16.2 Tour". After the tour is over, the preview interface is restored to the screen split mode before the tour.
Picture Storage	<p>Select the Snapshot check box to take a snapshot of the selected channel.</p>  <p>To use this function, select Main Menu > CAMERA > Encode > Snapshot, select Event in Type list.</p>
Buzzer	Select the check box to activate the buzzer when an alarm occurs.
Alarm Tone	<p>Check the box and then select the corresponding audio file from the drop-down list. System plays the audio file when the alarm occurs.</p>  <p>Refer to "4.17.1 File Management" to add audio file first.</p>

Step 3 Click **Apply** to save the settings.



- Click **Default** to restore the default setting.
- Click **Copy to**, in the **Copy to** dialog box, select the additional channel(s) that you want to copy the motion detection settings to, and then click **Apply**.
- Click **Test** to test the settings.

4.8.5.1.1 Setting the Motion Detection Region

Procedure

Step 1 Next to **Region**, click **Setting**.

The region setting screen is displayed.

Step 2 Point to the middle top of the interface.

The setting interface is displayed. See Figure 4-190.

Figure 4-190

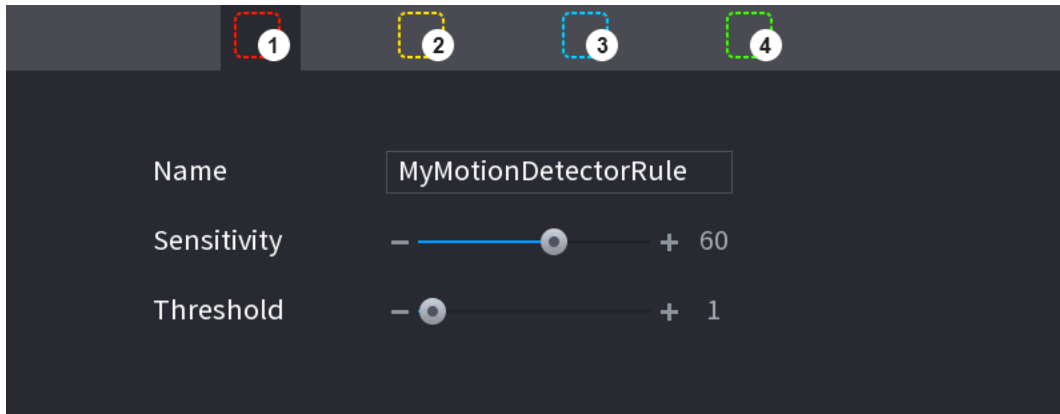

- Step 3** Configure the regions settings. You can configure totally four regions.
- Select one region, for example, click **1**.
 - Drag on the screen to select the region that you want to detect.
 - The selected area shows the color that represents the region.
 - Configure the parameters. See Table 4-58.

Table 4-58

Parameter	Description
Name	Enter a name for the region.
Sensitivity	Every region of every channel has an individual sensitivity value. The bigger the value is, the easier the alarms can be activated.
Threshold	Adjust the threshold for motion detect. Every region of every channel has an individual threshold.



When anyone of the four regions activates motion detect alarm, the channel where this region belongs to will activate motion detect alarm.

- Step 4** Right-click on the screen to exit the region setting interface.
- Step 5** On the **Motion Detection** interface, click **Apply** to complete the settings.

4.8.5.1.2 Setting Schedule

Background Information



The system only activates the alarm in the defined period.

Procedure

- Step 1** Next to **Schedule**, click **Setting**.
The Setting interface is displayed. See Figure 4-191.

Figure 4-191



Step 2 Define the motion detection period. By default, it is active all the time.

- Define the period by drawing.
 - ◇ Define for a specified day of a week: On the timeline, click the half-hour blocks to select the active period.
 - ◇ Define for several days of a week: Click before each day, the icon switches to . On the timeline of any selected day, click the half-hour blocks to select the active periods, all the days with will take the same settings.
 - ◇ Define for all days of a week: Click **All**, all switches to . On the timeline of any day, click the half-hour blocks to select the active periods, all the days will take the same settings.
- Define the period by editing. Take Sunday as an example.
 1. Click .

The **Period** interface is displayed. See Figure 4-192.

Figure 4-192

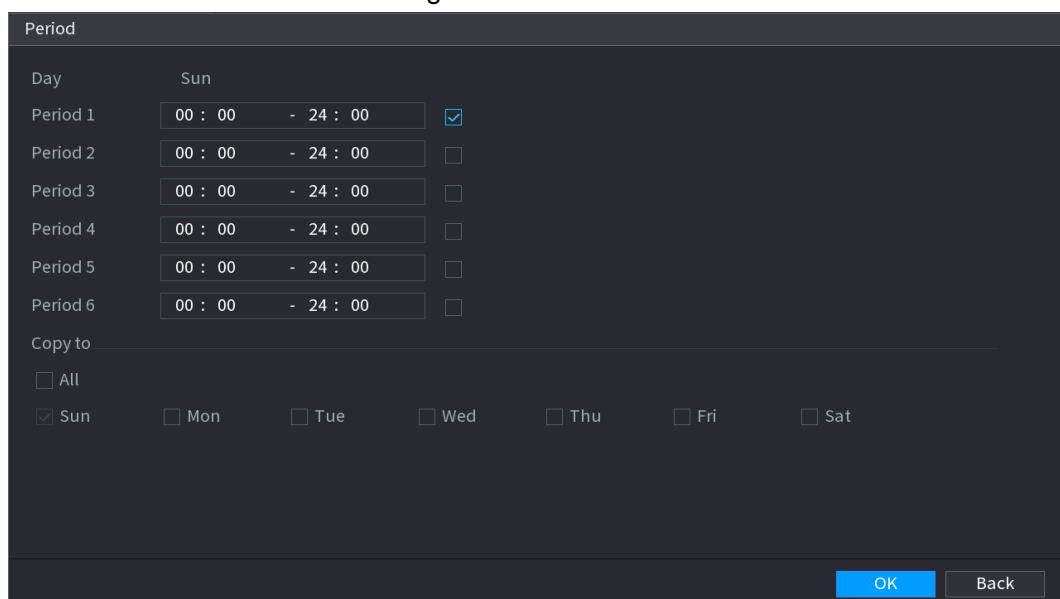

2. Enter the time frame for the period, and then select the check box to enable

the settings.

- ◇ There are six periods for you to set for each day.
- ◇ Under **Copy to**, select **All** to apply the settings to all the days of a week, or select specific day(s) that you want to apply the settings to.

3. Click **OK** to save the settings.

Step 3 On the **Motion Detection** interface, click **Apply** to complete the settings.

4.8.5.2 Video Tampering

Background Information

When the camera lens is covered, or the video is displayed in a single color because of sunlight status, the monitoring cannot be continued normally. To avoid such situations, you can configure the tampering alarm settings.

Procedure

Step 1 Select **Main Menu > ALARM > Video Detection > Video Tampering**. The **Video Tampering** interface is displayed. See Figure 4-193.

Figure 4-193

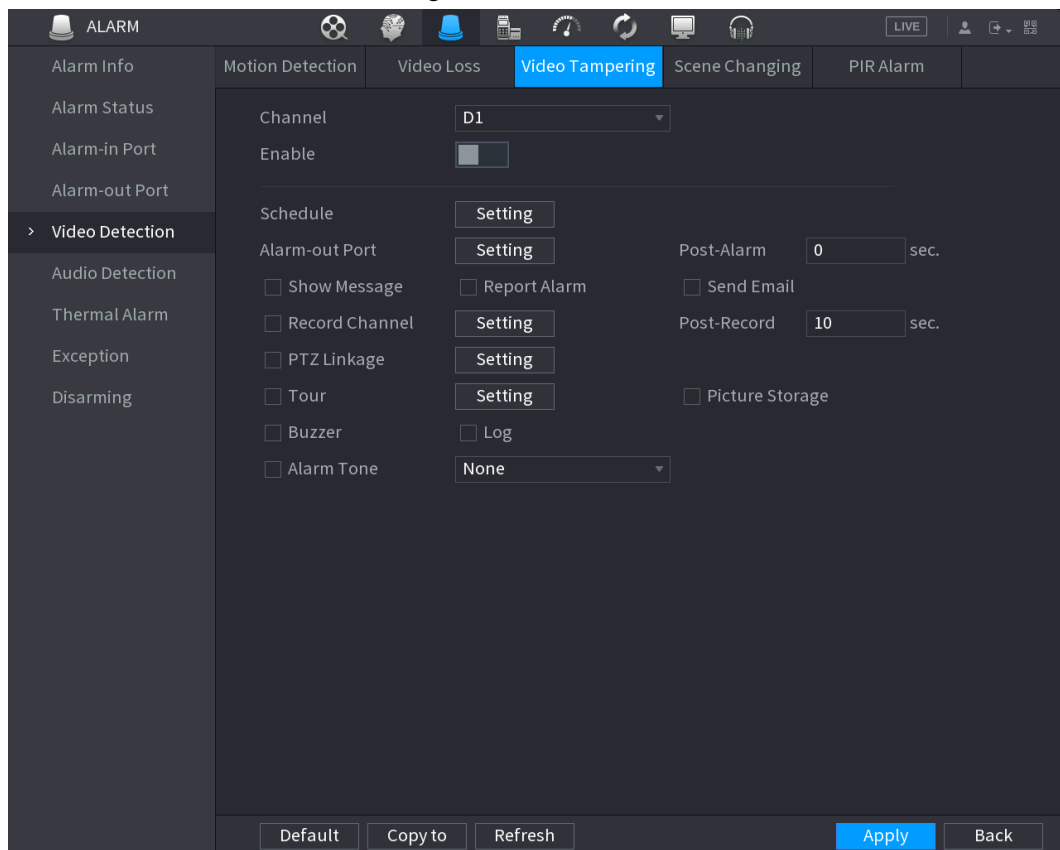

Step 2 To configure the settings for the tampering detection parameters, see "4.8.5.1 Motion Detection".



The Tampering function does not have region and sensitivity items.

Step 3 Click **Apply** to complete the settings.



- Click **Default** to restore the default setting.
- Click **Copy to**, in the **Copy to** dialog box, select the additional channel(s) that you want to copy the motion detection settings to, and then click **Apply**.

4.8.5.3 Video Loss

Background Information

When the video loss occurs, the system activates the alarm.

Procedure

- Step 1** Select **Main Menu > ALARM > Video Detection > Video Loss**.
The **Video Loss** interface is displayed. See Figure 4-194.

Figure 4-194

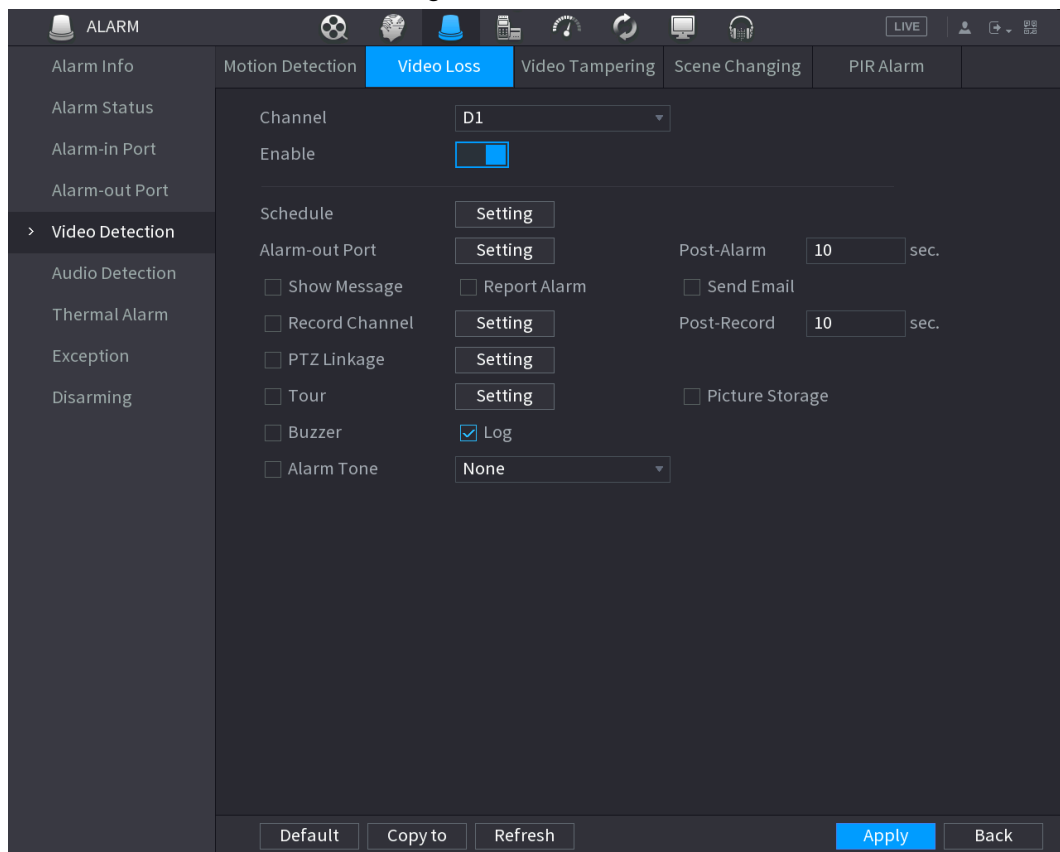

- Step 2** To configure the settings for the video loss detection parameters, see "4.8.5.1 Motion Detection".

The video loss function does not have region and sensitivity items.

- Step 3** Click **Apply** to complete the settings.



- Click **Default** to restore the default setting.
- Click **Copy to**, in the **Copy to** dialog box, select the additional channel(s) that you want to copy the motion detection settings to, and then click **Apply**.

4.8.5.4 Scene Change

Background Information

When the detected scene has changed, system can generate an alarm.

Procedure

- Step 1 Select **Main Menu > ALARM > Video Detection > Scene Changing**.
The **Scene Changing** interface is displayed. See Figure 4-195.

Figure 4-195

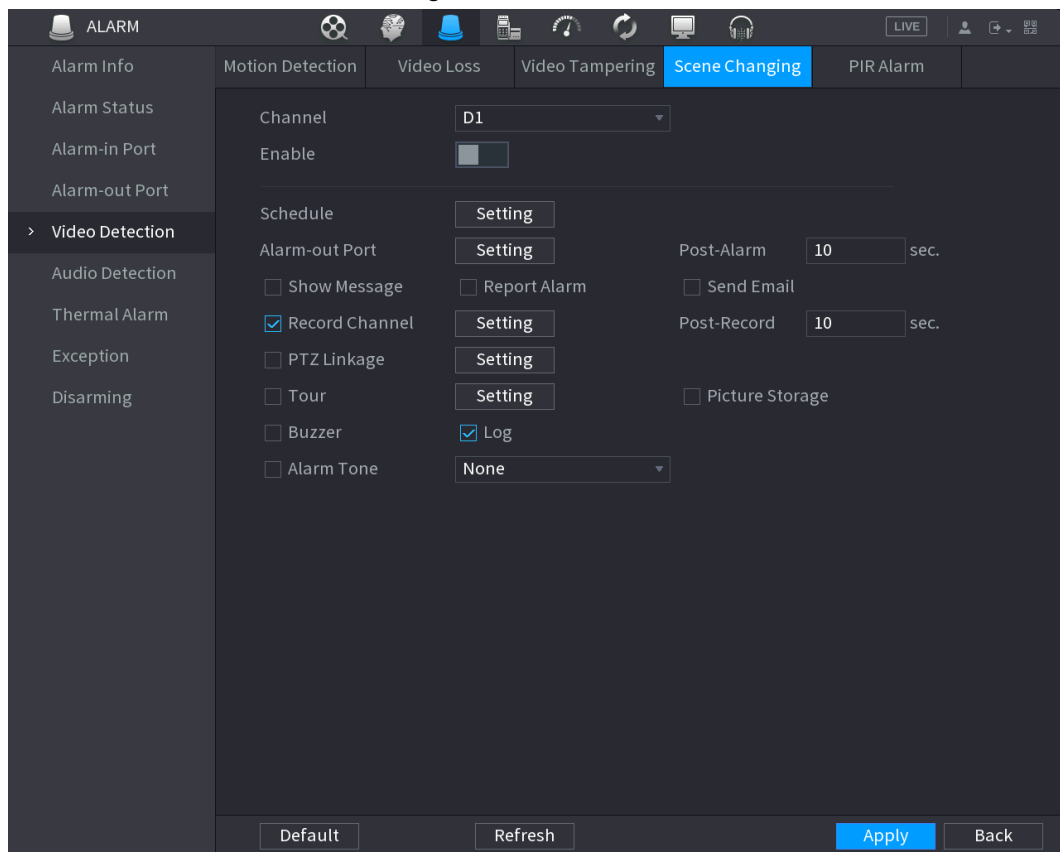

- Step 2 To configure the settings for the scene change parameters, see "4.8.5.1 Motion Detection".

- Step 3 The scene change function does not have region and sensitivity items.

- Step 4 Click Apply to complete the settings.



- Click **Default** to restore the default setting.
- Click **Copy to**, in the **Copy to** dialog box, select the additional channel(s) that you want to copy the motion detection settings to, and then click **Apply**.

4.8.5.5 PIR Alarm

Background Information

When the detected scene has changed, system can generate an alarm.

PIR function helps enhancing the accuracy and validity of motion detect. It can filter the meaningless alarms that are activated by the objects such as falling leaves, flies. The detection range by PIR is smaller than the field angle.

PIR function is enabled by default if it is supported by the cameras. Enabling PIR function will get the motion detect to be enabled automatically to generate motion detection alarms; if the PIR function is not enabled, the motion detect just has the general effect.

Procedure

- Step 1 Select **Main Menu > ALARM > Video Detection > PIR Alarm**.
The PIR Alarm interface is displayed. See Figure 4-196.

Figure 4-196

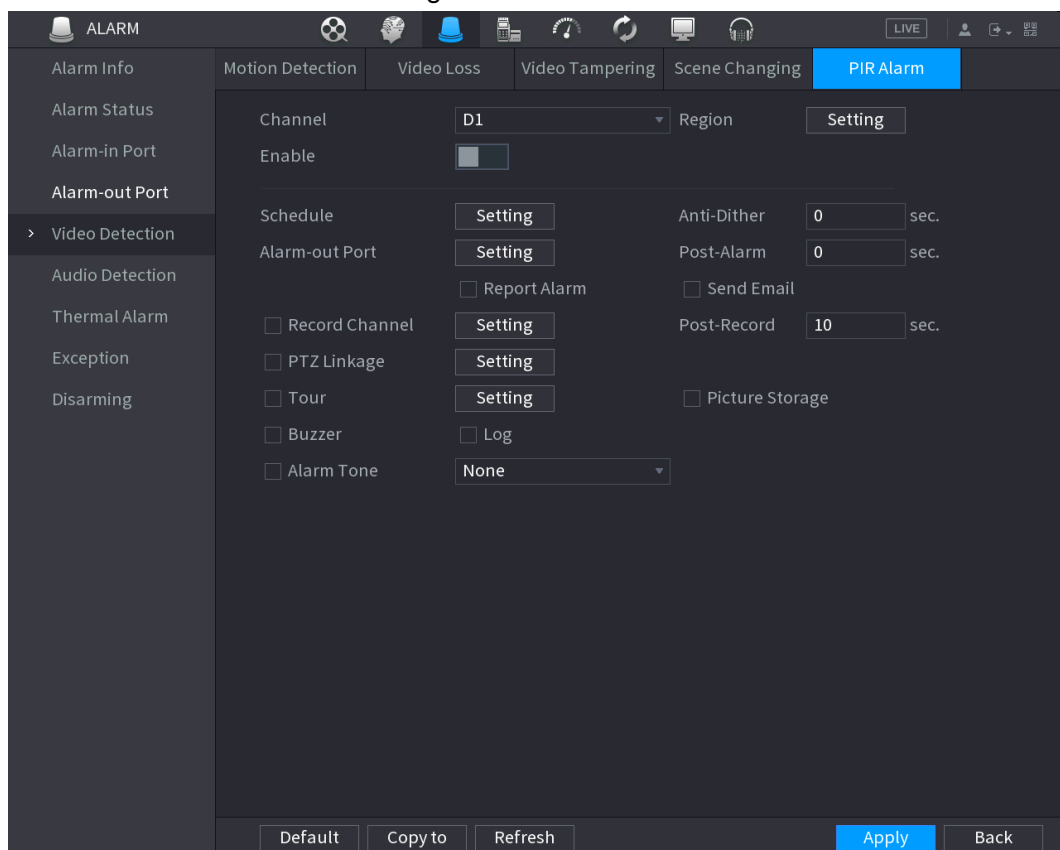

- Step 2 To configure the settings for the PIR alarm parameters, see "4.8.5.1 Motion Detection".
- Step 3 Click **Apply** to complete the settings.



- Click **Default** to restore the default setting.
- Click **Copy to**, in the **Copy to** dialog box, select the additional channel(s) that you want to copy the motion detection settings to, and then click **Apply**.

4.8.6 Audio Detection

Background Information

System can generate an alarm once it detect the audio is not clear, the tone color has changed or there is abnormal or audio volume changes.







Procedure

Step 1 Select **Main Menu > ALARM > Audio Detection**.

Step 2 Configure parameters. See Table 4-59.

Table 4-59

Parameter	Description
Channel	In the Channel list, select a channel to set.
Audio Exception	Check the box here, system can generate an alarm once the audio input is abnormal.
Intensity change	Check the box here, system can generate an alarm once the audio volume becomes strong.
Period	Define a period during which the function is active.
Sensitivity	The higher the value is, the easier it is to trigger an alarm. But at the same time, the false alarm may occur. The default value is recommended.
Threshold	You can set intensity change threshold. The smaller the value is, the higher the sensitivity is.
Period	Define a period during which the function is active.
Alarm Out	The alarm device (such as lights, sirens, etc.) is connected to the alarm output port. When an alarm occurs, the NVR device transmits the alarm information to the alarm device.
Latch	When the alarm ends, the alarm extended for a period of time. The time range is from 0 seconds to 300 seconds.
Show Message	Check box to enable a pop-up message in your local host PC.
Alarm Upload	<p>Select the check box. When an alarm occurs, the NVR device uploads an alarm signal to the network (including the alarm center).</p> <ul style="list-style-type: none"> • This function is for some series products only. • You need to set the alarm center first. For details, see "4.11.14 Alarm Center".

Parameter	Description
Send Email	<p>Select the check box. When an alarm occurs, the NVR device sends an email to the set mailbox to notify the user.</p>  <p>You need to set the email first. For details, see "4.11.11 Email".</p>
Record Channel	<p>Select the check box and select the needed recording channel (support multiple choices). When an alarm occurs, the NVR device activates the channel for recording.</p>  <p>You need to enable intelligent recording and auto recording first. For details, see "4.1.4.6 Schedule".</p>
PTZ Activation	<p>Select the check box and click Setting to select the channel and PTZ action. When an alarm occurs, the NVR device associates the channel to perform the corresponding PTZ action. For example, activate the PTZ in channel one to turn to the preset point X.</p>  <ul style="list-style-type: none"> • Tripwire alarm supports to activate PTZ preset point only. • You need to set the corresponding PTZ actions first, see "4.4.4 Calling PTZ Functions".
Delay	<p>At the end of the alarm, the recording extends for a period of time. The time range is from 10 seconds to 300 seconds.</p>
Tour	<p>Select the check box and select the channel for tour. When an alarm occurs, the local interface of the NVR device displays the selected channel screen.</p>  <ul style="list-style-type: none"> • You need to set the time interval and mode for tour first, see "4.16.2 Tour". • After the tour is over, the preview interface is restored to the screen split mode before the tour.
Snapshot	<p>Select the Snapshot check box to take a snapshot of the selected channel.</p>  <p>To use this function, select Main Menu > CAMERA > ENCODE > Snapshot, in the Mode list, select Event (Trigger).</p>
Log	<p>Select the check box, the NVR device records the alarm information in the log when an alarm occurs.</p>
Voice Prompts	<p>Check the box and then select the corresponding audio file from the dropdown list. System plays the audio file when the alarm occurs.</p>  <p>Refer to "4.17.1 File Management" to add audio file first.</p>
Buzzer	<p>Select the check box to activate the buzzer when an alarm occurs.</p>

Step 3 Click **Apply** to complete the settings.

4.8.7 Thermal Alarm

Background Information

System supports thermal devices and receives the alarm signal from it. It can recognize the alarm type, and then trigger the corresponding alarm actions.

The system supports fire alarm, temperature (temperature difference) and cold/hot alarm.

- **Fire alarm:** System generates an alarm once it detects there is a fire. The alarm mode includes Preset and Excluded zone.
- **Temperature (temperature difference):** System triggers an alarm once the temperature difference between two positions is higher or below the specified threshold.
- **Cold/hot alarm:** System triggers an alarm once the detected position temperature is higher or below the specified threshold.



- The connected channel shall support temperature test function.
- This function is for some series products only. It supports enable/disable function only. Go to the front-end device to set corresponding parameters.

Procedure

Step 1 Select **Main Menu > ALARM > Thermal Alarm**.

The **Thermal Alarm** interface is displayed. See Figure 4-197.

Figure 4-197

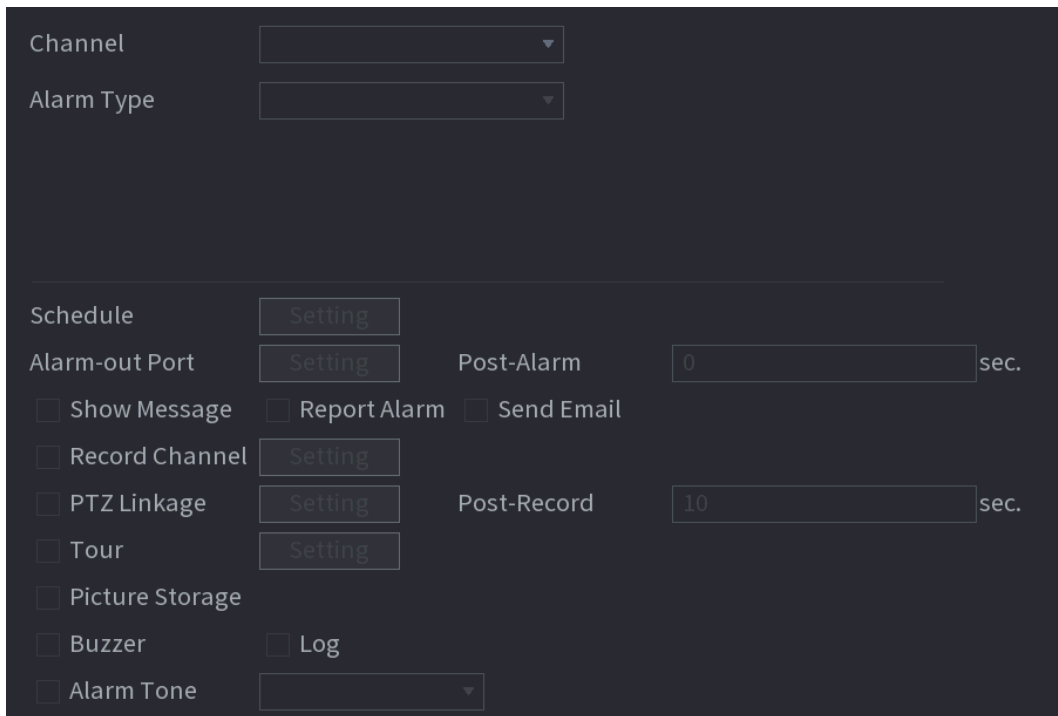

Step 2 Select a channel and alarm type, enable the thermal alarm function.





Step 3 Select fire mode and then enable this function (If the alarm type is **Fire Alarm**). System supports preset mode and zone excluded mode.



- **Preset:** Select a preset and then enable the function. System generates an alarm once it detect there is a fire.
- **Global:** System filters the specified high temperature zone. System generates an

alarm once the rest zone has fire.

Step 4 Set parameters. See Table 448.

Table 4-60

Parameter	Description
Alarm-out Port	The alarm device (such as lights, sirens, etc.) is connected to the alarm output port. When an alarm occurs, the NVR device transmits the alarm information to the alarm device.
Post-Alarm	When the alarm ends, the alarm extended for a period of time. The time range is from 0 seconds to 300 seconds.
Show Message	Check box to enable a pop-up message in your local host PC.
Report Alarm	<p>Select the check box. When an alarm occurs, the NVR device uploads an alarm signal to the network (including the alarm center).</p>  <ul style="list-style-type: none"> • This function is for some series products only. • You need to set the alarm center first. For details, see "4.11.14 Alarm Center".
Send Email	<p>Select the check box. When an alarm occurs, the NVR device sends an email to the set mailbox to notify the user.</p>  <p>You need to set the email first. For details, see "4.11.11 Email".</p>
Record Channel	<p>Select the check box and select the needed recording channel (support multiple choices). When an alarm occurs, the NVR device activates the channel for recording.</p>  <p>You need to enable intelligent recording and auto recording first. For details, see "4.1.4.6 Schedule".</p>
PTZ Linkage	<p>Select the check box and click Setting to select the channel and PTZ action. When an alarm occurs, the NVR device associates the channel to perform the corresponding PTZ action. For example, activate the PTZ in channel one to turn to the preset point X.</p>  <ul style="list-style-type: none"> • Tripwire alarm supports to activate PTZ preset point only. • You need to set the corresponding PTZ actions first, see "4.4.4 Calling PTZ Functions".
Delay	At the end of the alarm, the recording extends for a period of time. The time range is from 10 seconds to 300 seconds.

Parameter	Description
Tour	<p>Select the check box and select the channel for tour. When an alarm occurs, the local interface of the NVR device displays the selected channel screen.</p>  <ul style="list-style-type: none"> You need to set the time interval and mode for tour first, see "4.16.2 Tour". After the tour is over, the preview interface is restored to the screen split mode before the tour.
Snapshot	<p>Select the Snapshot check box to take a snapshot of the selected channel.</p>  <p>To use this function, select Main Menu > CAMERA > ENCODE > Snapshot, in the Mode list, select Event (Trigger).</p>
Log	<p>Select the check box, the NVR device records the alarm information in the log when an alarm occurs.</p>
Alarm Tone	<p>Check the box and then select the corresponding audio file from the dropdown list. System plays the audio file when the alarm occurs.</p>  <p>Refer to "4.17.1 File Management" to add audio file first.</p>
Buzzer	<p>Select the check box to activate the buzzer when an alarm occurs.</p>

Step 5 Click **Apply**.

4.8.8 Exception

Procedure

Step 1 Select **Main Menu > ALARM > Exception**.

The **Exception** interface is displayed. See Figure 4-198.

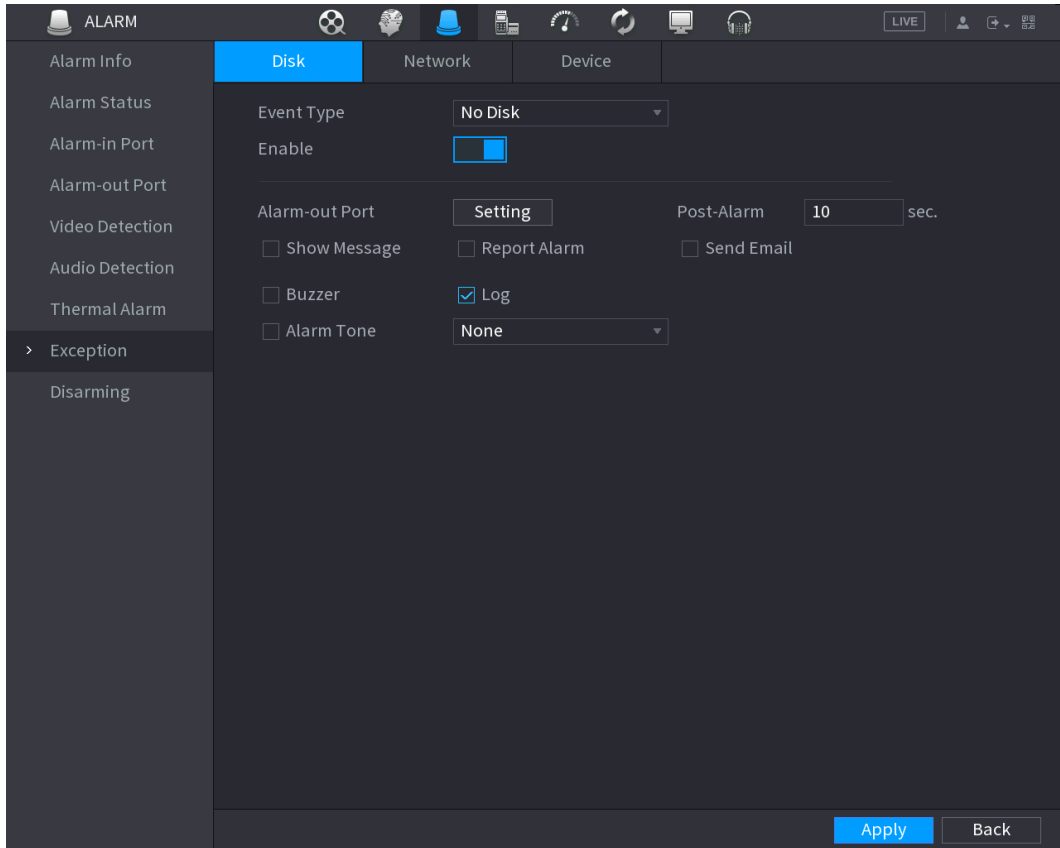

Figure 4-199

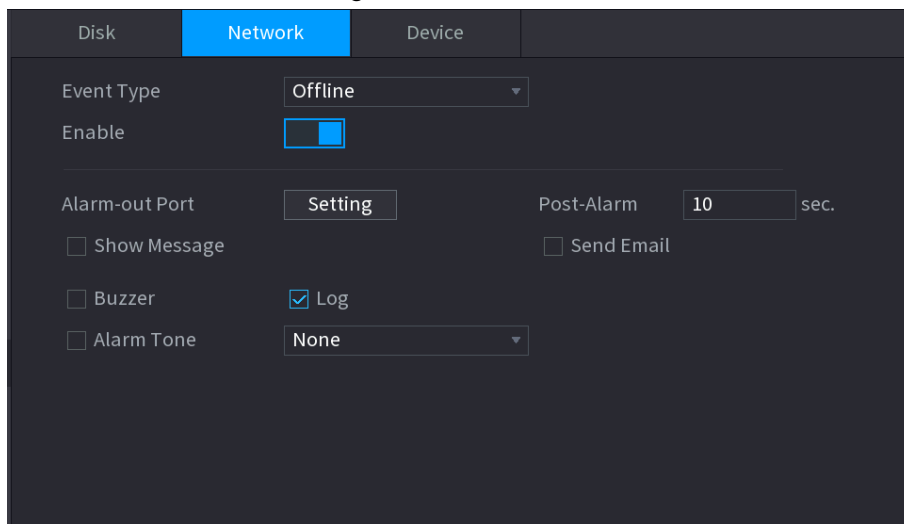







Figure 4-200

Step 2 Configure parameters. See Table 4-61.

Table 4-61

Parameter	Description
Event Type	<ul style="list-style-type: none"> Disk: Sets process method when there is a HDD event such as HDD error, no HDD, no space. Network: Sets process method when there is a network event such as disconnection, IP conflict, MAC conflict. Device: Sets process method when there is a device event such as fan speed exception. <p>Different series products support different event types. The actual product shall prevail.</p>
Enable	Check the box to enable the function.
Less than	System generates an alarm once the HDD space is less than the threshold. <p>For HDD No Space type only.</p>
Alarm-out Port	The alarm device (such as lights, sirens, etc.) is connected to the alarm output port. When an alarm occurs, the NVR device transmits the alarm information to the alarm device.
Post-Alarm	When the alarm ends, the alarm extended for a period of time. The time range is from 0 seconds to 300 seconds.
Show Message	Check box to enable a pop-up message in your local host PC.
Report Alarm	Select the check box. When an alarm occurs, the NVR device uploads an alarm signal to the network (including the alarm center). <ul style="list-style-type: none"> This function is for some series products only. You need to set the alarm center first. For details, see "4.11.14 Alarm Center".

Parameter	Description
Send Email	<p>Select the check box. When an alarm occurs, the NVR device sends an email to the set mailbox to notify the user.</p>  <p>You need to set the email first. For details, see "4.11.11 Email".</p>
Record Channel	<p>Select the check box and select the needed recording channel (support multiple choices). When an alarm occurs, the NVR device activates the channel for recording.</p>  <p>You need to enable intelligent recording and auto recording first. For details, see "4.1.4.6 Schedule".</p>
PTZ Linkage	<p>Select the check box and click Setting to select the channel and PTZ action. When an alarm occurs, the NVR device associates the channel to perform the corresponding PTZ action. For example, activate the PTZ in channel one to turn to the preset point X.</p>  <ul style="list-style-type: none"> • Tripwire alarm supports to activate PTZ preset point only. • You need to set the corresponding PTZ actions first, see "4.4.4 Calling PTZ Functions".
Tour	<p>Select the check box and select the channel for tour. When an alarm occurs, the local interface of the NVR device displays the selected channel screen.</p>  <ul style="list-style-type: none"> • You need to set the time interval and mode for tour first, see "4.16.2 Tour". • After the tour is over, the preview interface is restored to the screen split mode before the tour.
Snapshot	<p>Select the Snapshot check box to take a snapshot of the selected channel.</p>  <p>To use this function, select Main Menu > CAMERA > ENCODE > Snapshot, in the Mode list, select Event (Trigger).</p>
Log	<p>Select the check box, the NVR device records the alarm information in the log when an alarm occurs.</p>
Alarm Tone	<p>Check the box and then select the corresponding audio file from the drop-down list. System plays the audio file when the alarm occurs.</p>  <p>Refer to "4.17.1 File Management" to add audio file first.</p>
Buzzer	<p>Select the check box to activate the buzzer when an alarm occurs.</p>

Step 3 Click **Apply**.

4.8.9 Disarming

You can disarm all alarm linkage actions as needed.

Procedure

Step 1 Select **Main Menu > Alarm > Disarming**.

Step 2 Click to enable disarming.

Figure 4-201

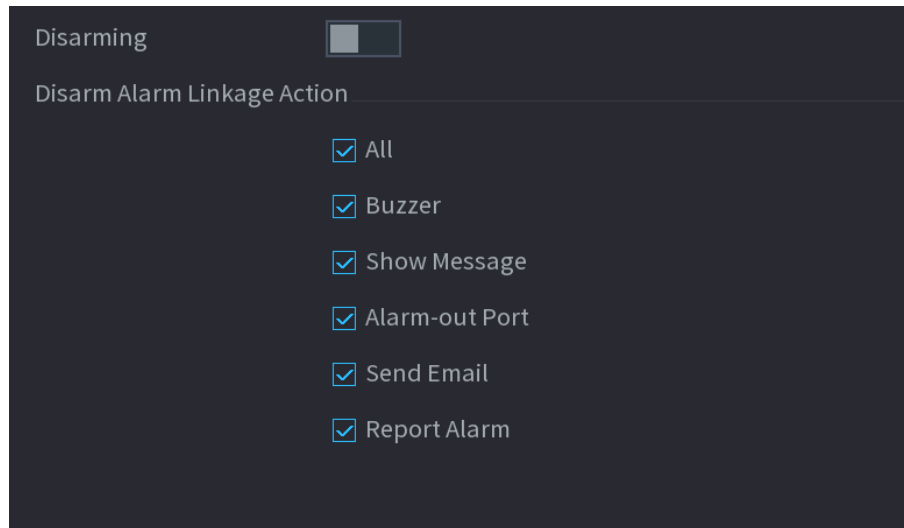

Step 3 Select alarm linkage actions to disarm.



All alarm linkage actions will be disarmed when you select **All**.

Step 4 Click **Apply**.

4.9 POS

You can connect the Device to the POS (Point of Sale) machine and receive the information from it. This function applies to the scenarios such as supermarket POS machine. After connection is established, the Device can access the POS information and display the overlaid text in the channel window.



Playing POS information in the local playback and viewing the POS information in the live view screen support single-channel mode and four-channel mode. Displaying monitoring screen and playing back in the web support multi-channel mode.

4.9.1 Search

Background Information



The system supports fuzzy search.

Procedure

- Step 1** Select **Main Menu > POS > POS Search**.
The **POS Search** interface is displayed. See Figure 4-202.

Figure 4-202 POS search

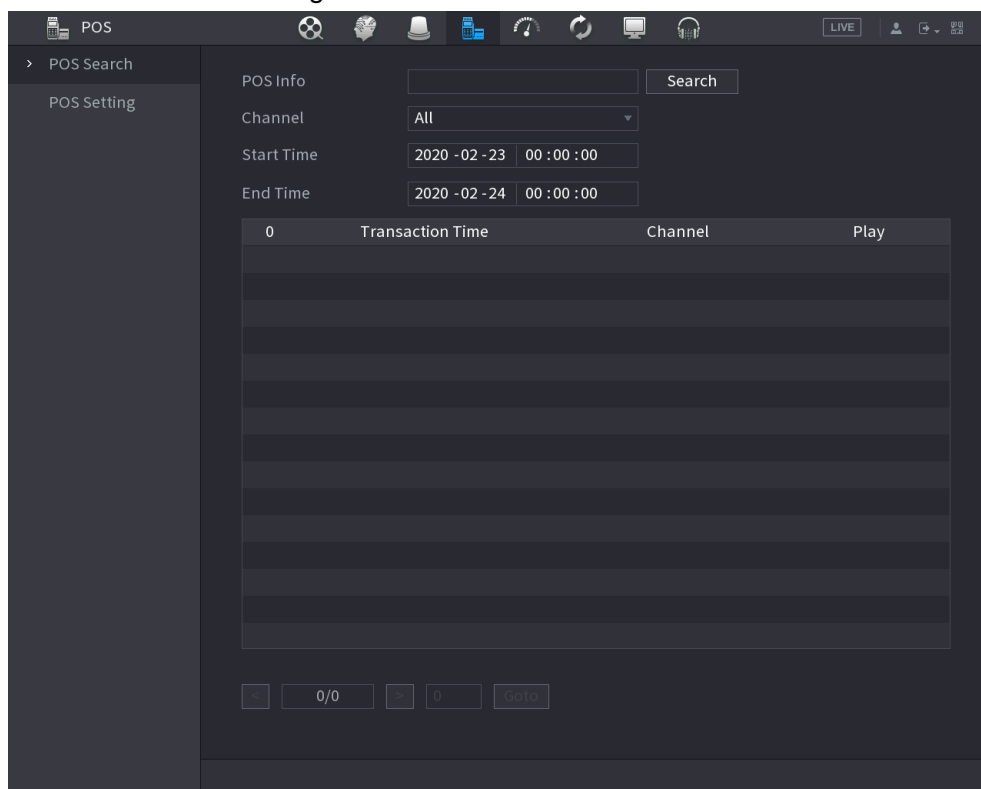

- Step 2** In the **POS Search** box, enter the information such as transaction number on your receipt, amount, or product name.
- Step 3** In the **Start Time** box and **End Time** box, enter the time period that you want to search the POS transaction information.
- Step 4** Click **Search**.
The searched transaction results display in the table.

4.9.2 Settings

Procedure

- Step 1** Select **Main Menu > POS > POS Setting**.
The **POS Setting** interface is displayed. See Figure 4-202.

Figure 4-203 POS setting

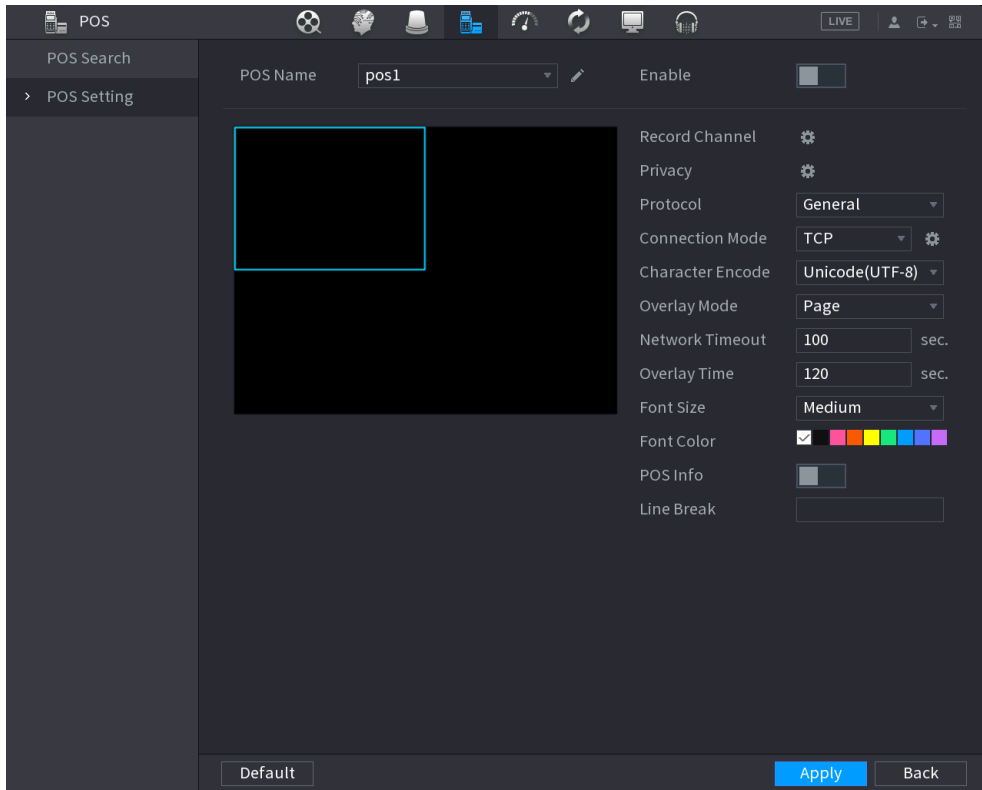

- Step 2** Configure the settings for the POS parameters. See Table 4-62.

Table 4-62 POS parameters

Parameter	Description
POS Name	In the POS Name list, select the POS machine that you want to configures settings for. Click to modify the POS name. <ul style="list-style-type: none"> The POS name shall be unique. The POS name supports 21 Chinese characters or 63 English characters.
Enable	Enable the POS function.
Record Channel	Click to select a channel to record.
Privacy	Enter the privacy contents. Refer to "4.9.2.1 Privacy Setup".
Protocol	Select POS by default. Different machine corresponds to different protocol.
Connection Mode	In the Connection Mode list, select the connection protocol type. Click , the IP Address interface is displayed. In the Source IP box, enter the IP address (the machine that is connected to the Device) that sends messages.

Parameter	Description
Character Encode	Select a character encoding mode.
Overlay Mode	<p>In the Overlay Mode list, Select Turn or ROLL.</p> <ul style="list-style-type: none"> • Turn: Once the information is at 16 lines, system displays the next page. • ROLL: Once the information is at 16 lines, system rolls one line after another to delete the first line.  <p>When the local preview mode is in 4-split, the turn/ROLL function is based on 8 lines.</p>
Network time out	When the network is not working correctly and cannot be recovered after the entered timeout limit, the POS information will not display normally. After the network is recovered, the latest POS information will be displayed.
Time Display	Enter the time that how long you want to keep the POS information displaying. For example, enter 5, the POS information disappear from the screen after 5 seconds.
Font Size	In the Font Size list, select Small , Medium , or Big as the text size of POS information
Font Color	In the color bar, click to select the color for the text size of POS information.
POS Info	Enable the POS Info function, the POS information displays in the live view/WEB.
Line Break	<p>There is no line delimiter by default.</p> <p>After set the line delimiter (HEX), the overlay information after the delimiter is displayed in the new line. For example, the line delimiter is F and the overlay information is 123156789, NVR displays overlay information on the local preview interface and Web as:</p> <p>123 6789</p>

Step 3 Click **Apply** to complete the settings.

4.9.2.1 Privacy Setup

Procedure

Step 1 Click  next to **Privacy**.

The **Privacy** interface is displayed. See Figure 4-204.

Figure 4-204

Step 2 Set privacy information.

Step 3 Click **OK**.

4.9.2.2 Connection Mode

Background Information

Connection type is UDP or TCP.

Procedure

Step 1 Select **Connection Mode** as **UDP**, **TCP_CLINET** or **TCP**.

Step 2 Click .

The **IP Address** interface is displayed. See Figure 4-205.

Figure 4-205 IP address

Step 3 Enter **Source IP** and **Port**. Refers to POS IP address and port.

Step 4 Click **OK** to complete setup.

4.10 Operation and Maintenance

4.10.1 Log

Background Information

You can view and search the log information, or backup log to the USB device.

Procedure

- Step 1** Select **Main Menu > MAINTAIN > Log**.
The **Log** interface is displayed. See Figure 4-206.

Figure 4-206

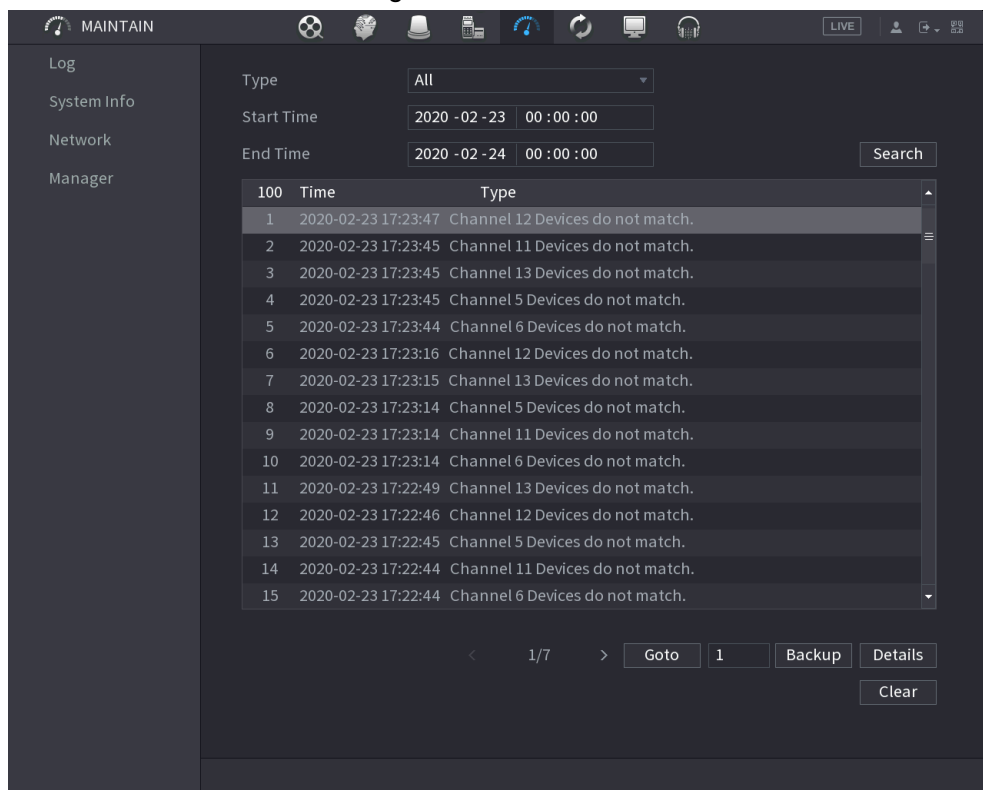

- Step 2** In the **Type** list, select the log type that you want to view (**System, Config, Storage, Record, Account, Clear Log, Playback, and Connection**) or select **All** to view all logs.

- Step 3** In the **Start Time** box and **End Time** box, enter the time period to search, and then click **Search**.

The search results are displayed.

Figure 4-207

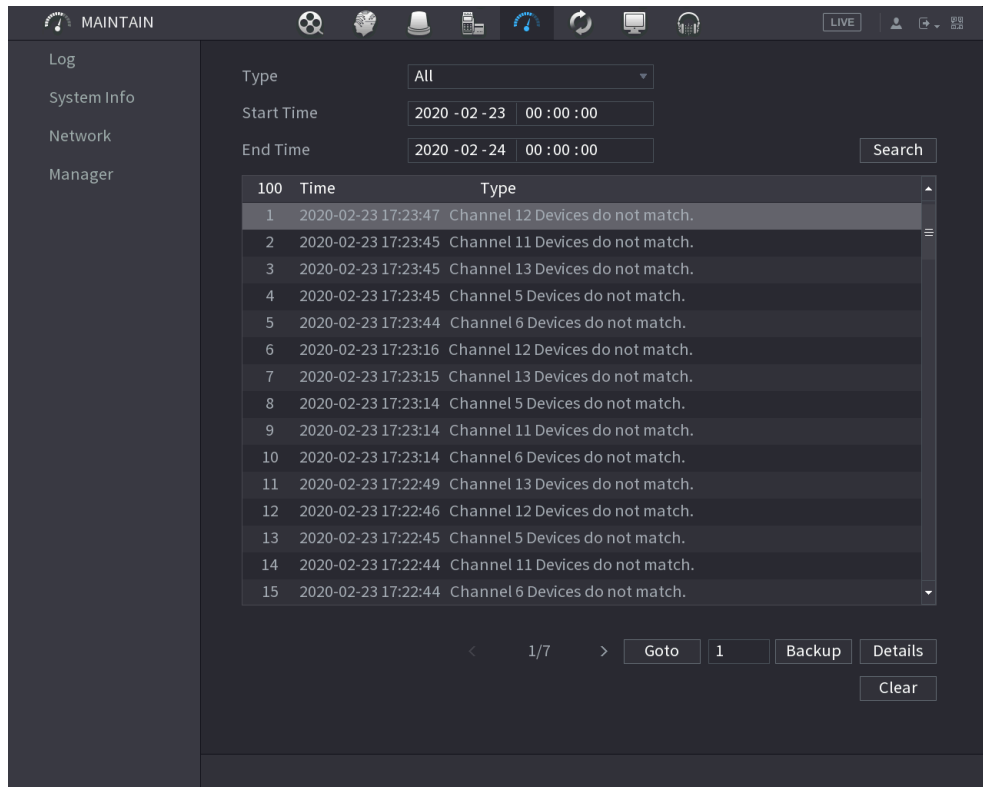

- Click **Details** or double-click the log that you want to view, the **Detailed Information** interface is displayed. Click **Next** or **Previous** to view more log information.
- Click **Backup** to back up the logs into the USB storage device.
- Click **Clear** to remove all logs.

4.10.2 System

4.10.2.1 System Version

Select **Main Menu > MAINTAIN > System Info > Version**.

You can view NVR version information. Slight different may be found on the user interface.

4.10.2.2 AI Algorithm Version

Select **Main Menu > MAINTAIN > System Info > Intelligent Algorithm**.

You can view version information for AI functions such as face detection, face recognition, IVS, and video metadata.

The interface prompts are different for different permission status of algorithms.

4.10.2.3 HDD Info

You can view the HDD quantity, HDD type, total space, free space, status, and S.M.A.R.T information.

Select **Main Menu > MAINTAIN > System Info > Disk**, the **Disk** interface is displayed. See Figure 4-208. Refer to Table 4-63 for detailed information.

Figure 4-208

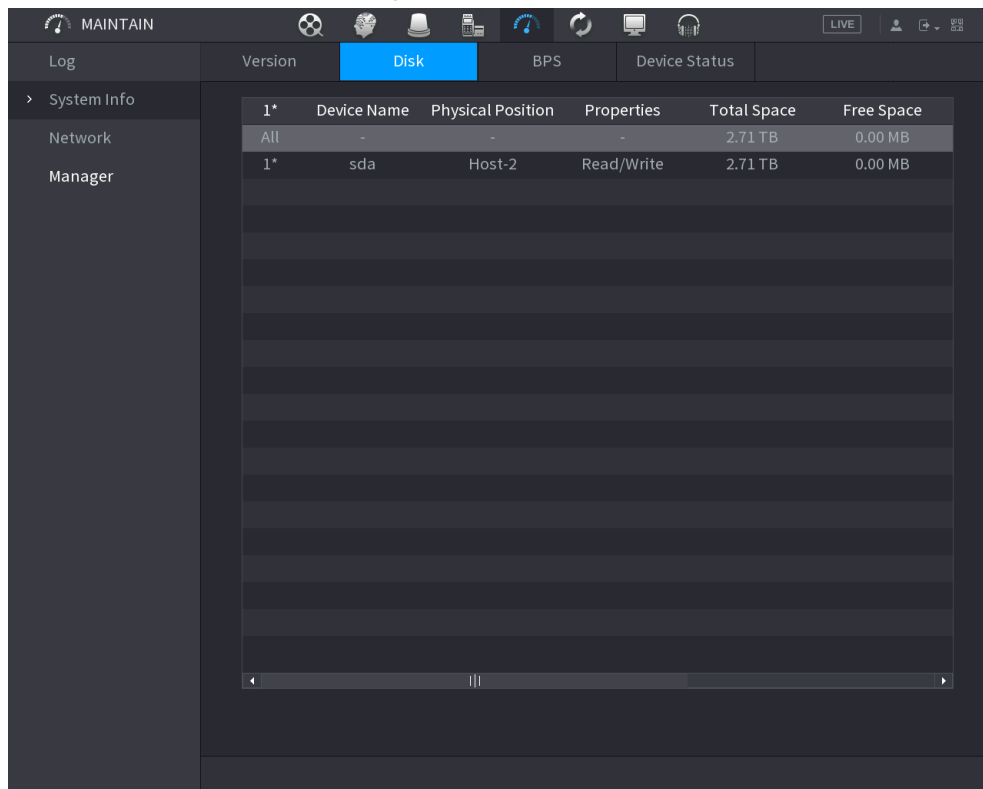

Table 4-63

Parameter	Description
No.	Indicates the number of the currently connected HDD. The asterisk (*) means the current working HDD.
Device Name	Indicates name of HDD.
Physical Position	Indicates installation position of HDD.
Properties	Indicates HDD type.
Total Space	Indicates the total capacity of HDD.
Free Space	Indicates the usable capacity of HDD.
Health Status	Indicates the health status of the HDD.
S.M.A.R.T	View the S.M.A.R.T reports from HDD detecting.
Status	Indicates the status of the HDD to show if it is working normally.

4.10.2.4 BPS

Here is for you to view current video bit rate (kb/s) and resolution.

Select **Main Menu > MAINTAIN > System Info > BPS**, the **BPS** interface is displayed. See Figure 4-209.

Figure 4-209

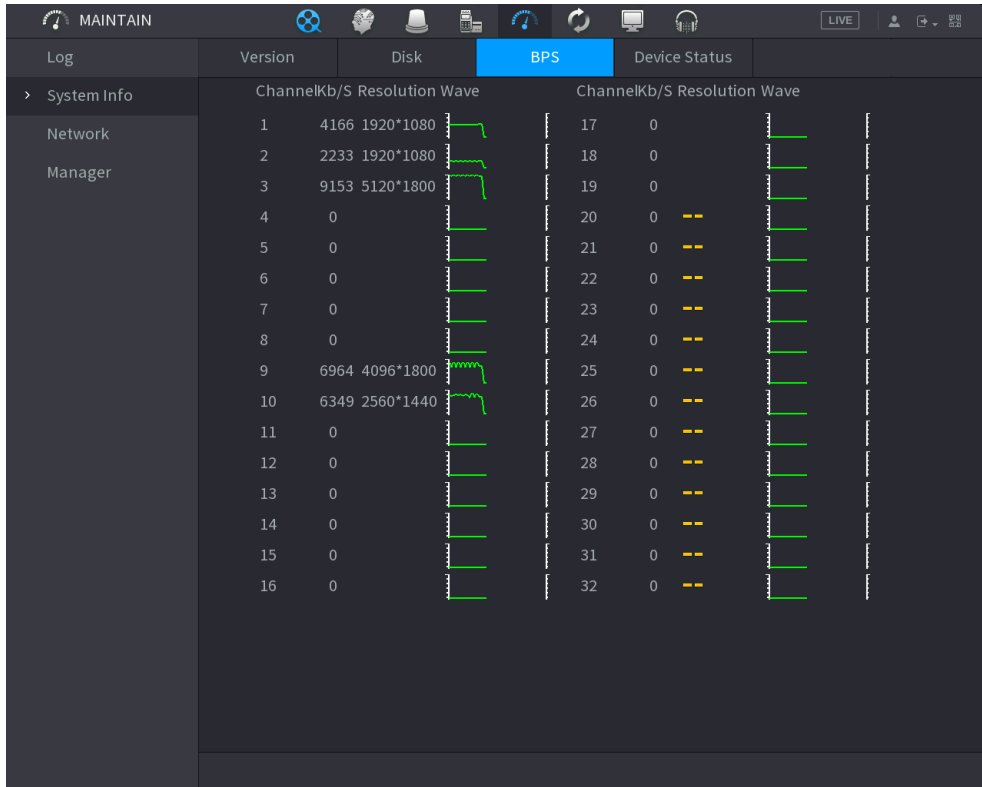

4.10.2.5 Device Status

You can view fan running status such as speed, CPU temperature, and memory.
 Select **Main Menu > MAINTAIN > System Info > Device Status**, the **Device Status** interface is displayed. See Figure 4-210.

Figure 4-210

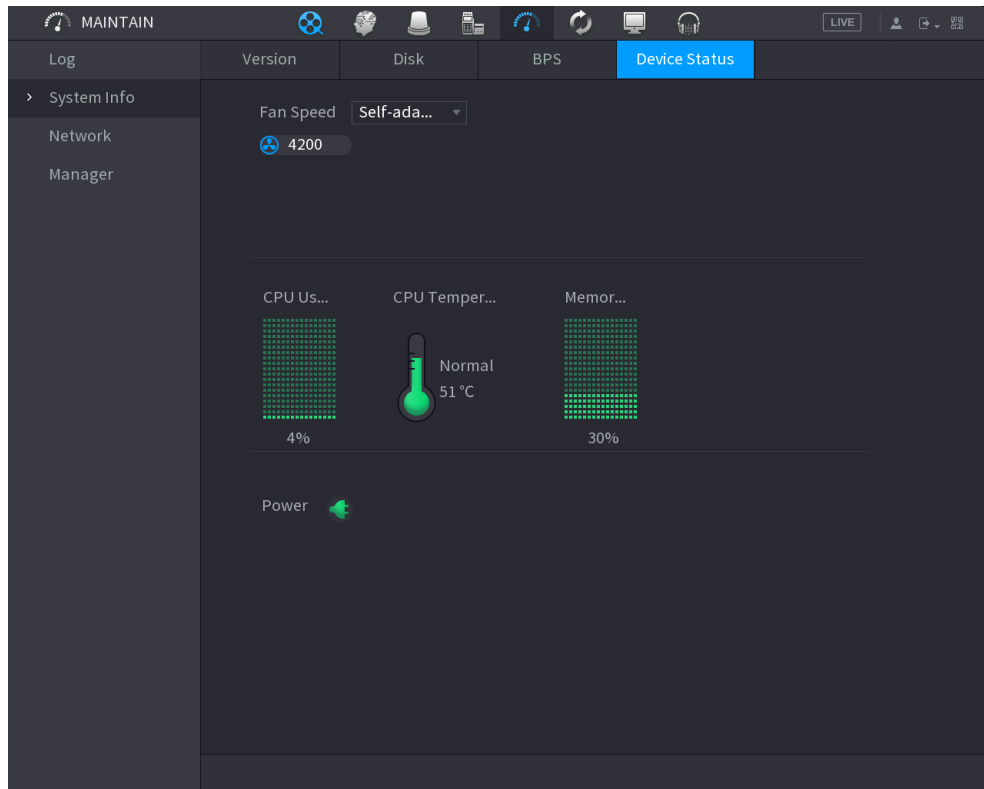

4.10.3 Network

4.10.3.1 Online User

You can view the online user information or block any user for a period of time. To block an online user, click  and then enter the time that you want to block this user. The maximum value you can set is 65535.

The system detects every 5 seconds to check whether there is any user added or deleted, and update the user list timely.

Select **Main Menu > MAINTAIN > Network > Online User**, the **Online User** interface is displayed. See Figure 4-211.

Figure 4-211

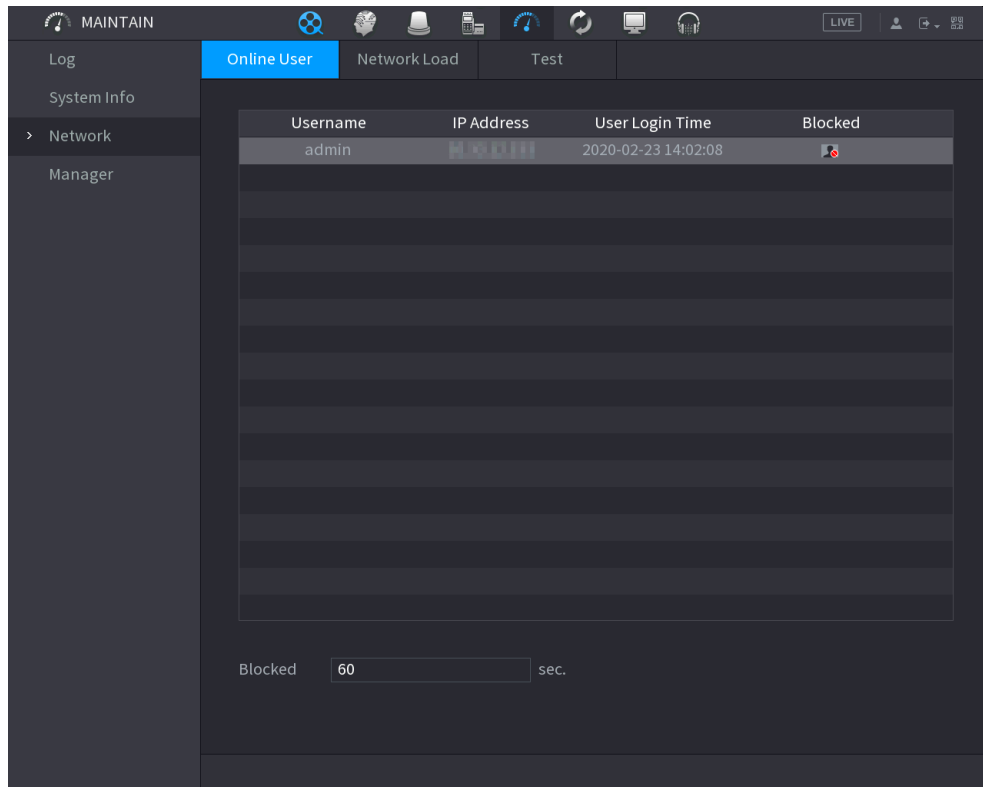

4.10.3.2 Network Load

Background Information

Network load means the data flow which measures the transmission capability. You can view the information such as data receiving speed and sending speed.

Procedure

- Step 1 Select **Main Menu > MAINTAIN > Network > Network Load**.
The **Network Load** interface is displayed. See Figure 4-212.

Figure 4-212

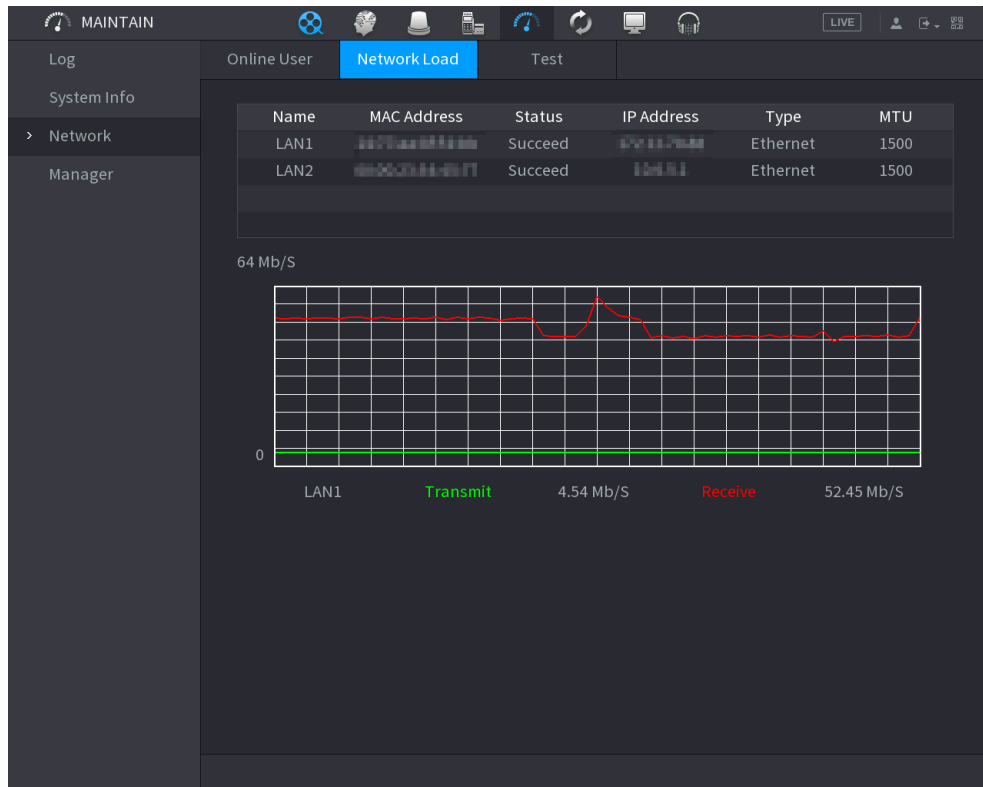

Step 2 Click the LAN name that you want to view, for example, **LAN1**.
The system displays the information of data sending speed and receiving speed.



- System displays LAN1 load by default.
- Only one LAN load can be displayed at one time.

4.10.3.3 Network Test

Background Information

You can test the network connection status between the Device and other devices.

Procedure

Step 1 Select **Main Menu > MAINTAIN > Network > Test**.
The **Test** interface is displayed. See Figure 4-213.

Figure 4-213

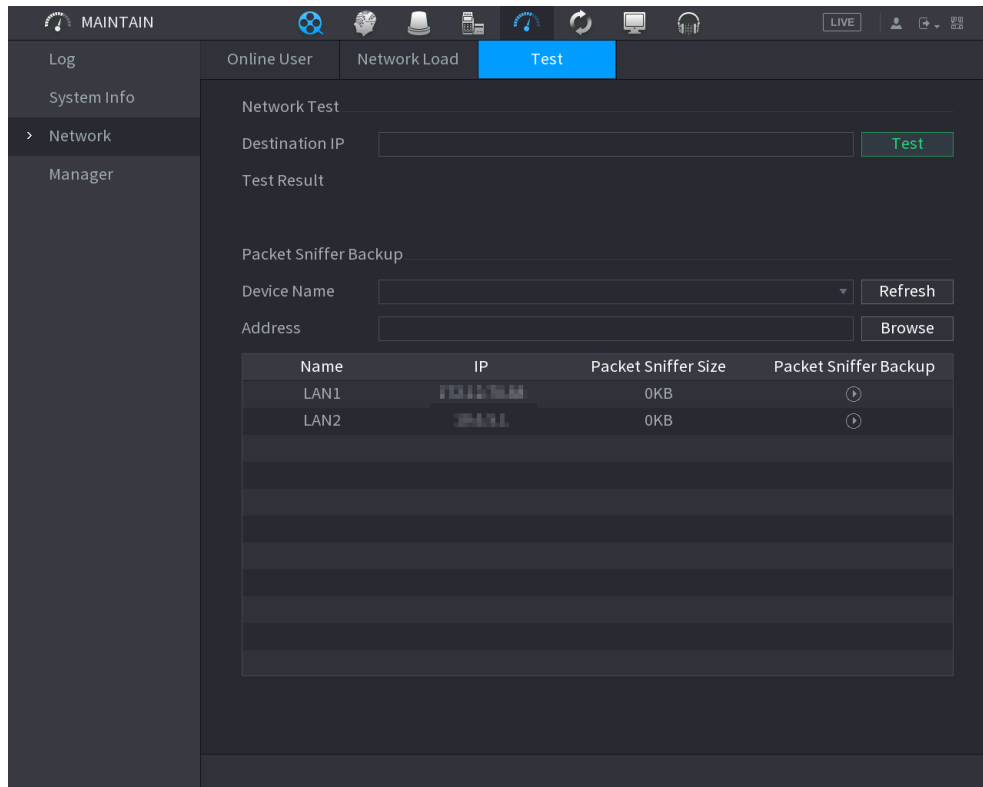

Step 2 In the **Destination IP** box, enter the IP address.

Step 3 Click **Test**.

After testing is completed, the test result is displayed. You can check the evaluation for average delay, packet loss, and network status.

4.10.4 Maintenance and Management

4.10.4.1 Device Maintenance

Background Information

When the Device has been running for a long time, you can configure the auto reboot when the Device is not working. You can also configure the case fan mode to reduce noise and extend the service life.

Procedure

Step 1 Select **Main Menu > MAINTAIN > Manager > Maintenance**.
The **Maintenance** interface is displayed. See Figure 4-214.

Figure 4-214

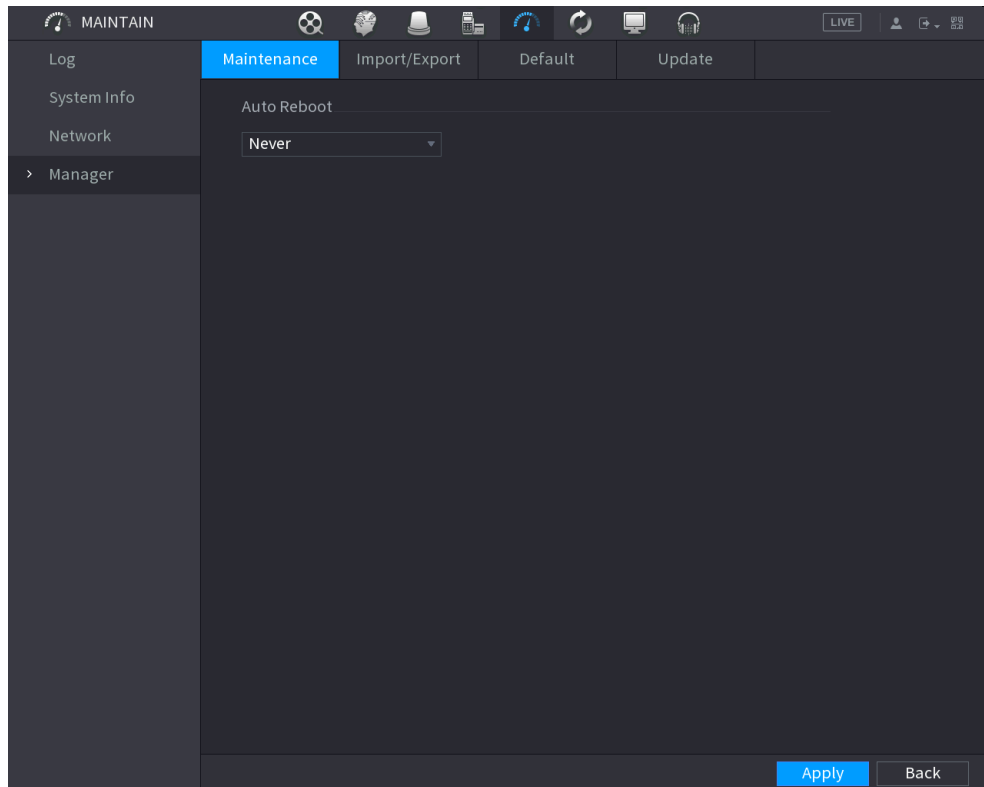

Step 2 Configure the settings for the system maintenance parameters. See Table 4-64.

Table 4-64

Parameter	Description
Auto Reboot	In the Auto Reboot list, select the reboot time.
Case Fan Mode	<p>In the Case Fan Mode list, you can select Always run or Auto. If you select Auto, the case fan will stop or start according to the external conditions such as the Device temperature.</p> <p> This function is for some series products only, and it is only supported on the local configuration interface.</p>

Step 3 Click **Apply** to complete the settings.

4.10.4.2 Exporting System Settings

Background Information

You can export or import the Device system settings if there are several Devices that require the same setup.



- The **Import/Export** interface cannot be opened if the backup operation is ongoing on the other interfaces.
- When you open the **Import/Export** interface, the system refreshes the devices and sets the current directory as the first root directory.
- Click **Format** to format the USB storage device.

Procedure

- Step 1 Select **Main Menu > MAINTAIN > Manager > Import/Export**.
The **Import/Export** interface is displayed. See Figure 4-215.

Figure 4-215

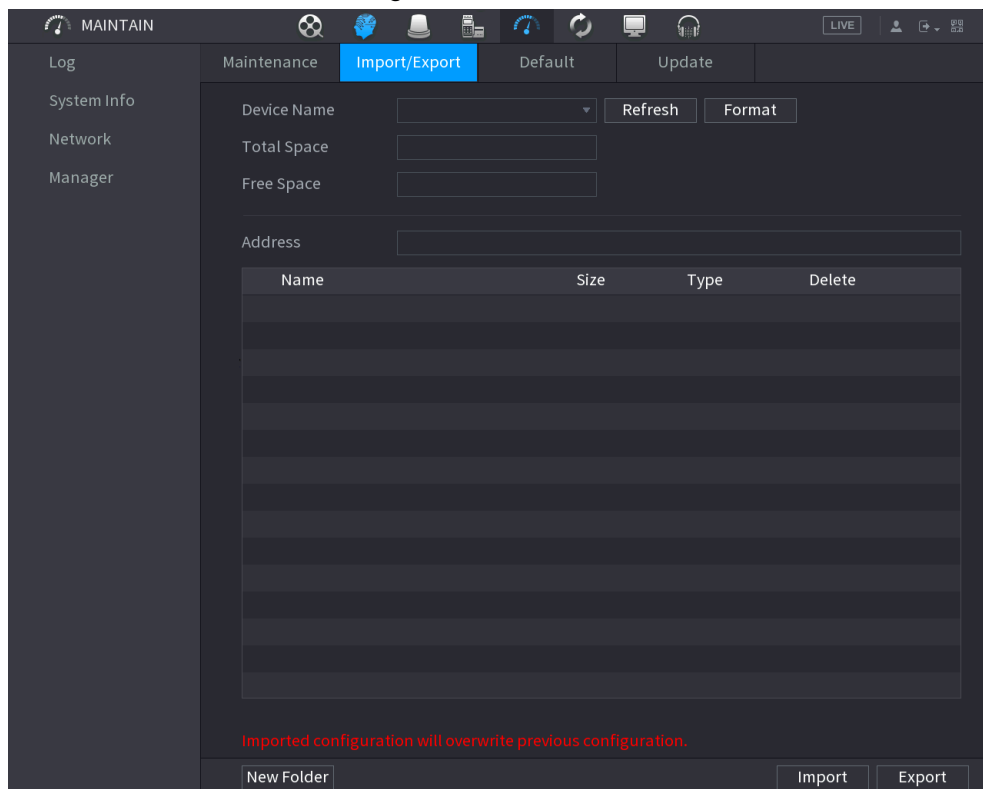

- Step 2 Insert a USB storage device into one of the USB ports on the Device.

- Step 3 Click **Refresh** to refresh the interface.

The connected USB storage device is displayed. See Figure 4-216.

Figure 4-216

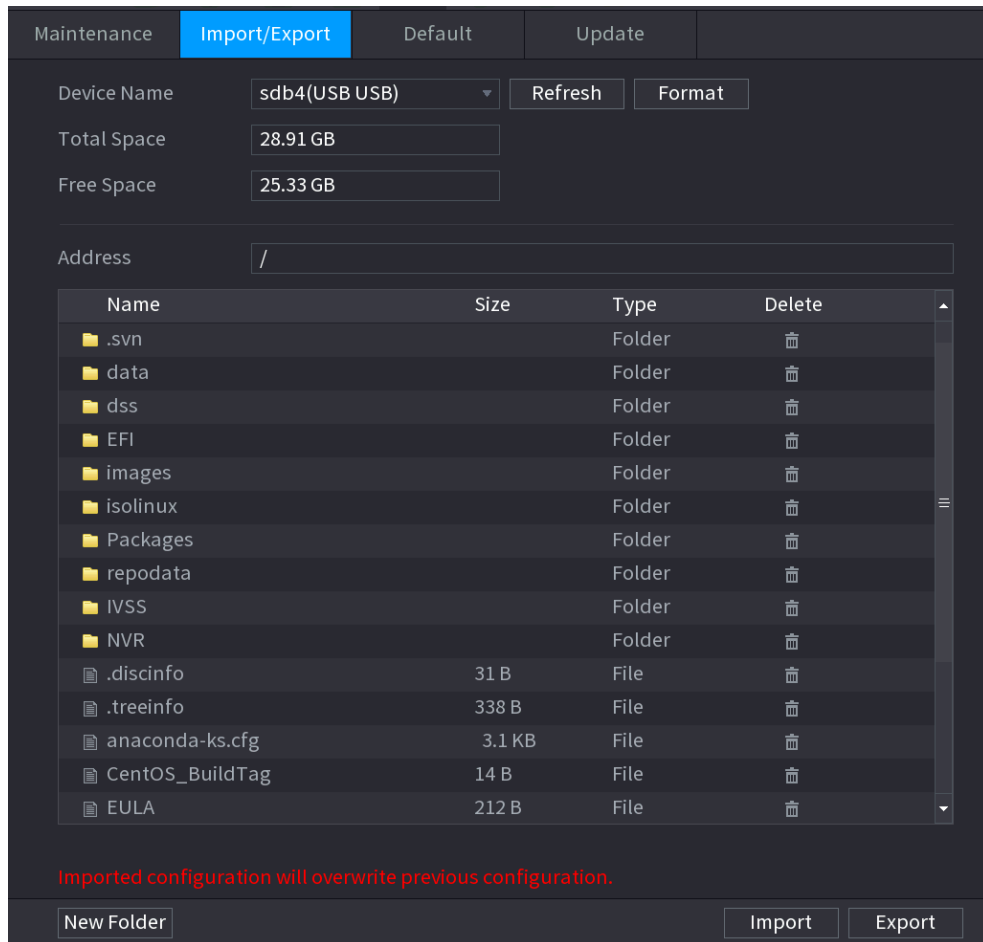

- Step 4** Click **Export**.
 There is a folder under the name style of "Config_[YYYYMMDDhhmmss]".
 Double-click this folder to view the backup files.

4.10.4.3 Default

Background Information



This function is for admin account only.

You can select the settings that you want to restore to the factory default.

Procedure

- Step 1** Select **Main Menu > MAINTAIN > Manager > Default**.
 The **Default** interface is displayed. See Figure 4-217.

Figure 4-217

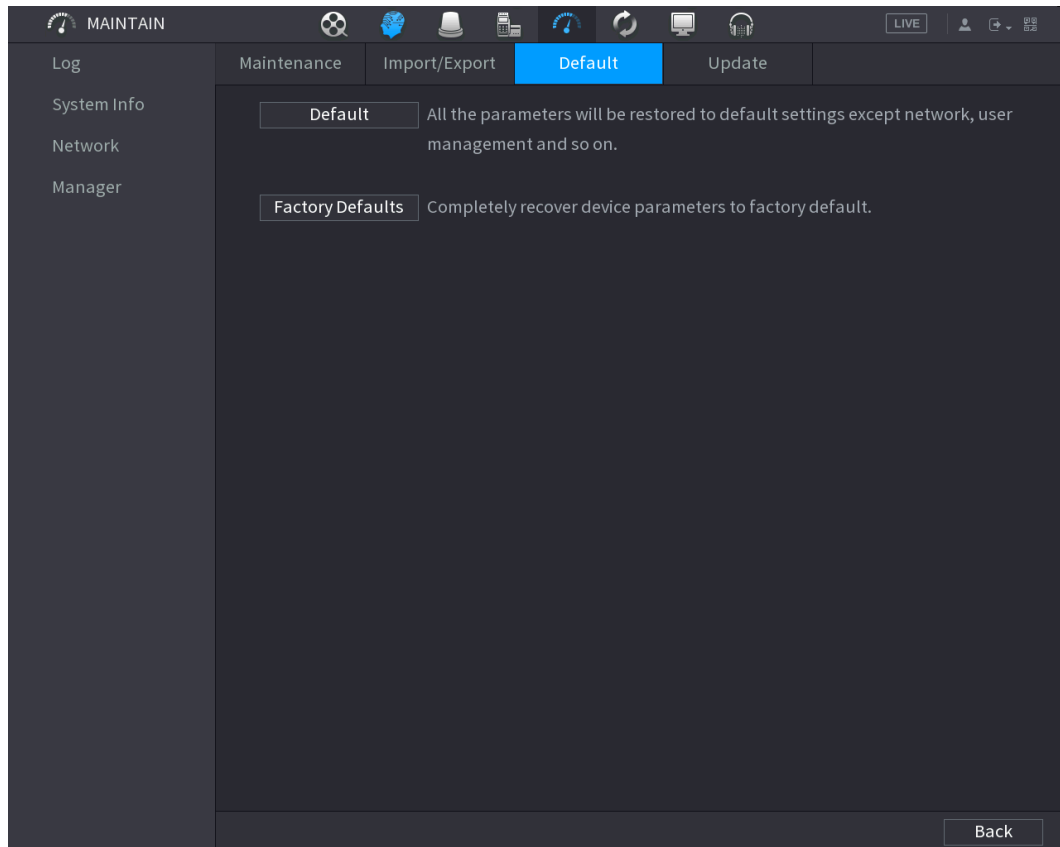

Step 2 Restore the settings.

- Click **Default**, and then click **OK** in the prompted dialog box. The system starts restoring the selected settings.
- Click **Factory Default**, and then click **OK** in the prompted dialog box.
 1. Enter the admin password in the second dialog box.
 2. Click **OK**.
 The system starts restoring the whole settings.

4.10.4.4 System Update

4.10.4.4.1 Upgrading File

Procedure

- Step 1** Insert a USB storage device containing the upgrade files into the USB port of the Device.
- Step 2** Select **Main Menu > MAINTAIN > Manager > Update**
The **Update** interface is displayed. See Figure 4-218.

Figure 4-218

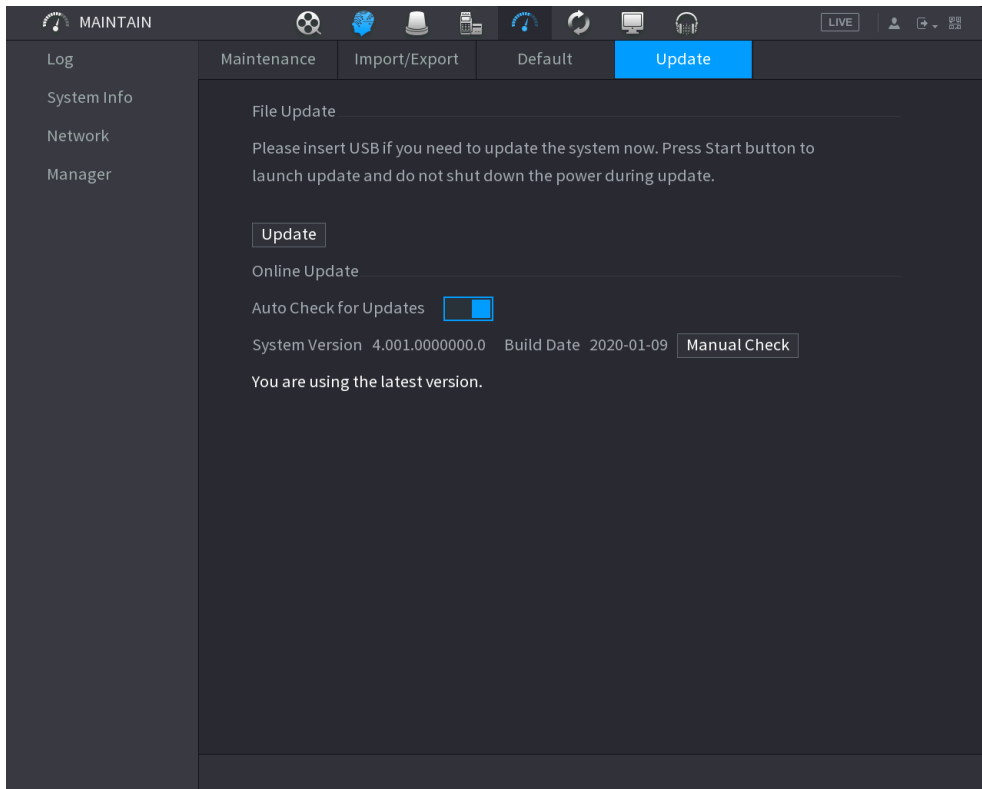

- Step 3** Click **Update**.
The **Update** interface is displayed. See Figure 4-219.

Figure 4-219

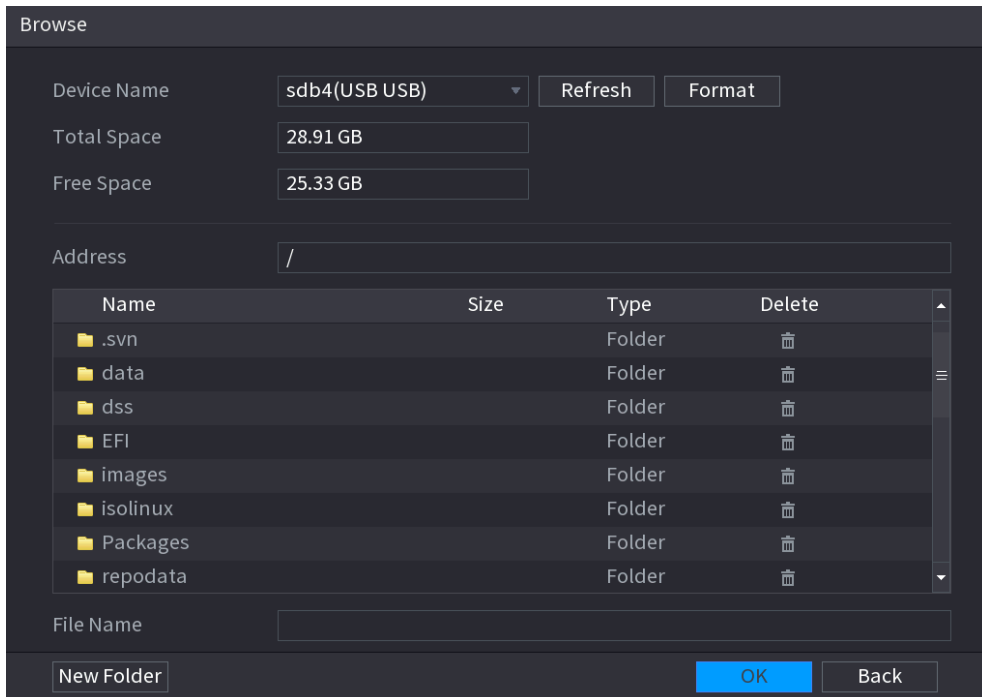

- Step 4** Click the file that you want to upgrade.
Step 5 The selected file is displayed in the **Update File** box.
Step 6 Click **Start**.

4.10.4.4.2 Online Upgrade

Background Information

When the Device is connected to Internet, you can use online upgrade function to upgrade the system.

Before using this function, you need to check whether there is any new version by auto check or manual check.

- Auto check: The Device checks if there is any new version available at intervals.
- Manual check: Perform real-time check whether there is any new version available.



Ensure the correct power supply and network connection during upgrading; otherwise the upgrading might be failed.

Procedure

- Step 1** Select **Main Menu > MAINTAIN > Manager > Update**.
The **Update** interface is displayed. See Figure 4-220.

Figure 4-220

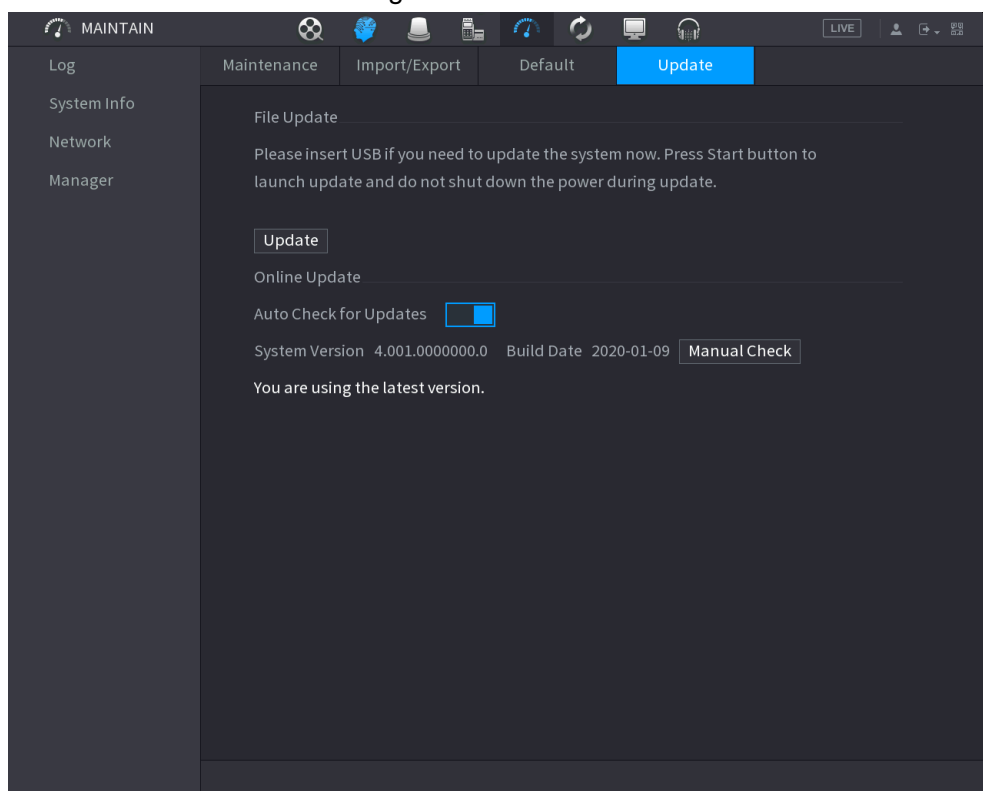

- Step 2** Check whether there is any new version available.
- Auto-check for updates: Enable Auto-check for updates.
 - Manual check: Click **Manual Check**.
- The system starts checking the new versions. After checking is completed, the check result is displayed.
- If the "It is the latest version" text is displayed, you do not need to upgrade.
 - If the text indicating there is a new version, go to the step 3.
- Step 3** Click **Update now** to update the system.

4.10.4.4.3 Uboot Upgrading



- Under the root directory in the USB storage device, there must be "u-boot.bin.img" file and "update.img" file saved, and the USB storage device must be in FAT32 format.
- Make sure the USB storage device is inserted; otherwise the upgrading cannot be performed.

When starting the Device, the system automatically check whether there is a USB storage device connected and any upgrade file, and if yes and the check result of the upgrade file is correct, the system will upgrade automatically. The Uboot upgrade can avoid the situation that you have to upgrade through +TFTP when the Device is halted.

4.11 Network

You can set NVR network parameters so that the NVR can communicate with devices in the same LAN.

4.11.1 TCP/IP

Select **Main Menu > NETWORK > TCP/IP**, the **TCP/IP** interface is displayed. See Figure 4-221.

Figure 4-221 TCP/IP

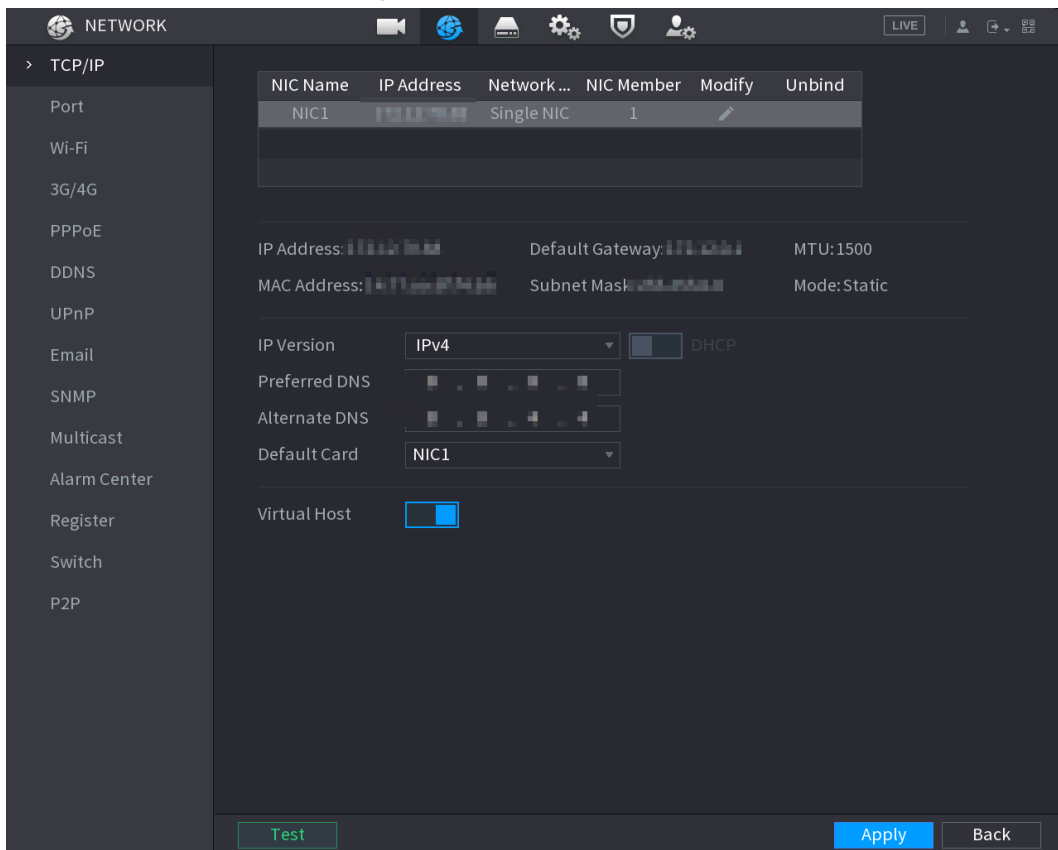



Table 4-65

Parameter	Description
Net Mode	<ul style="list-style-type: none"> ● Multi-address: Two Ethernet ports work separately through either of which you can request the Device to provide the services such as HTTP and RTSP. You need to configure a default Ethernet port (usually the Ethernet port 1 by default) to request the services from the device end such as DHCP, Email and FTP. If one of the two Ethernet ports is disconnected as detected by networking testing, the system network status is regarded as offline. ● Fault Tolerance: Two Ethernet ports share one IP address. Normally only one Ethernet port is working and when this port fails, the other port will start working automatically to ensure the network connection. ● When testing the network status, the network is regarded as offline only when both of the two Ethernet ports are disconnected. The two Ethernet ports are used under the same LAN. ● Load Balance: Two network cards share one IP address and they are working at the same time to share the network load averagely.  <p>The Device with single Ethernet port does not support this function.</p>
Default Ethernet Port	In the Ethernet Card list, select an Ethernet port as a default port. This setting is available only when the Multi-address is selected in the Net Mode list.
IP Version	In the IP Version list, you can select IPv4 or IPv6. Both versions are supported for access.
MAC Address	Displays the MAC address of the Device.
DHCP	<p>Enable the DHCP function. The IP address, subnet mask and default gateway are not available for configuration once DHCP is enabled.</p> <ul style="list-style-type: none"> ● If DHCP is effective, the obtained information will display in the IP Address box, Subnet Mask box and Default Gateway box. If not, all values show 0.0.0.0. ● If you want manually configure the IP information, disable the DHCP function first. ● If PPPoE connection is successful, the IP address, subnet mask, default gateway, and DHCP are not available for configuration.
IP Address	Enter the IP address and configure the corresponding subnet mask and default gateway.
Subnet Mask	
Default Gateway	 <p>IP address and default gateway must be in the same network segment.</p>
DNS DHCP	Enable the DHCP function to get the DNS address from router.

Parameter	Description
Preferred DNS	In the Preferred DNS box, enter the IP address of DNS.
Alternate DNS	In the Alternate DNS box, enter the IP address of alternate DNS.
MTU	<p>In the MTU box, enter a value for network card. The value ranges from 1280 byte through 1500 byte. The default is 1500.</p> <p>The suggested MTU values are as below.</p> <ul style="list-style-type: none"> • 1500: The biggest value of Ethernet information package. This value is typically selected if there is no PPPoE or VPN connection, and it is also the default value of some routers, network adapters and switches. • 1492: Optimized value for PPPoE. • 1468: Optimized value for DHCP. • 1450: Optimized value for VPN.
Test	Click Test to test if the entered IP address and gateway are interworking.

4.11.2 Port

Background Information

You can configure the maximum connection accessing the Device from Client such as WEB, Platform, and Mobile Phone and configure each port settings.

Procedure

- Step 1 Select **Main Menu > NETWORK > Port**.
The **Port** interface is displayed. See Figure 4-222.

Figure 4-222

Max Connection	128	(0 - 128)
TCP Port	37777	(1025 - 65535)
UDP Port	37778	(1025 - 65535)
HTTP Port	80	(1 - 65535)
HTTPS Port	443	(1 - 65535)
RTSP Port	554	(1 - 65535)
NTP Server Port	123	(1 - 65535)
POS Port	38800	(1025 - 65535)

- Step 2 Configure the settings for the connection parameters. See Table 4-66.



The connection parameters except Max Connection cannot take effects until the Device has been restarted.

Table 4-66

Parameter	Description
Max Connection	The allowable maximum clients accessing the Device at the same time, such as WEB, Platform, and Mobile Phone. Select a value between 1 and 128. The default value setting is 128.
TCP Port	The default value setting is 37777. You can enter the value according to your actual situation.
UDP Port	The default value setting is 37778. You can enter the value according to your actual situation.
HTTP Port	The default value setting is 80. You can enter the value according to your actual situation. If you enter other value, for example, 70, and then you should enter 70 after the IP address when logging in the Device by browser.
RTSP Port	The default value setting is 554. You can enter the value according to your actual situation.
POS Port	Data transmission. The value range is from 1 through 65535. The default value is 38800.
HTTPS Enable	Enable HTTPS .
HTTPS Port	HTTPS communication port. The default value setting is 443. You can enter the value according to your actual situation.

Step 3 Click **Apply** to complete the settings.

4.11.3 External Wi-Fi

The device can be connected via wireless network with an external Wi-Fi module, and it can reduce the difficulty of device connection without a network cable.

Prerequisites

Make sure that external Wi-Fi module is installed on the device.

Background Information



This function is supported on select models.

Procedure

Step 1 Select **Main Menu > NETWORK > Wi-Fi**.

Figure 4-223

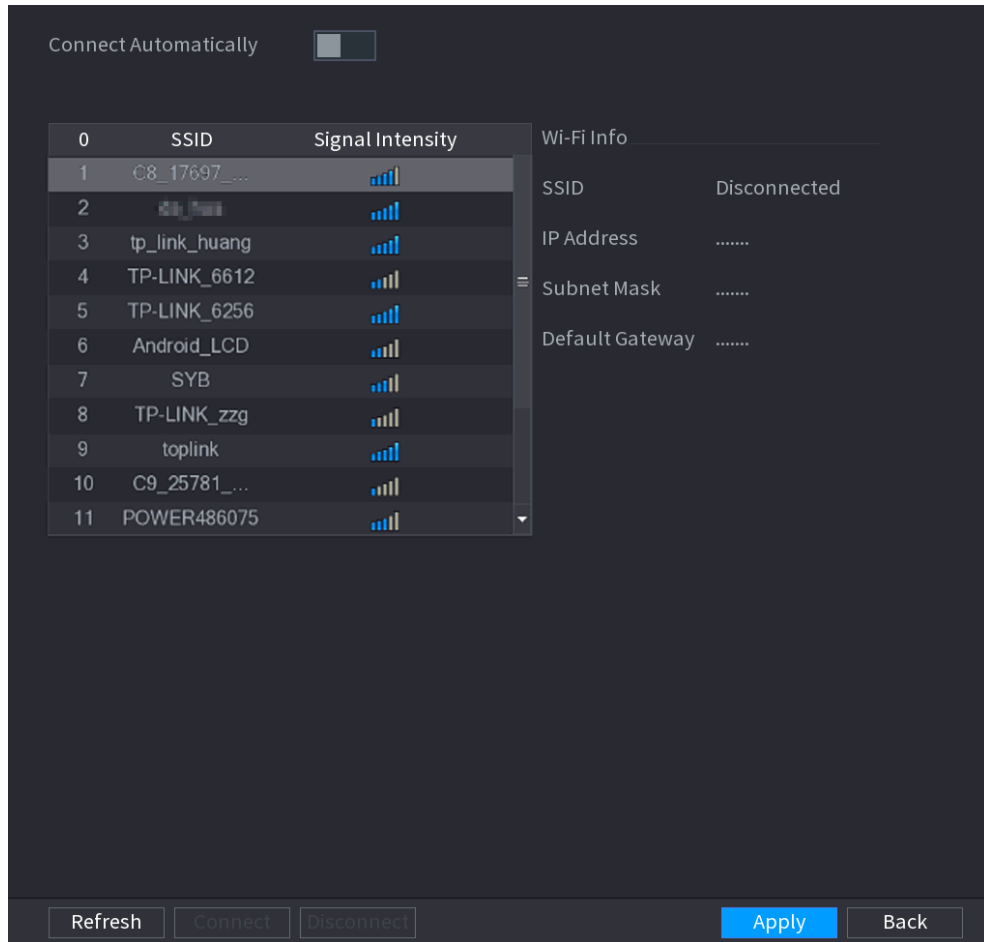

Step 2 Select a site and click **Connect**.

Table 4-67

Parameter	Description
Connect Automatically	After it is enabled, the NVR will connect to the nearest site that was previously successfully connected after boot-up.
Refresh	Re-search the site.
Disconnect	Disconnect the current connection.
Connect	Select the available sites that you want to connect to. When the NVR is connected to a site and then select another site to connect, the current site will be disconnected before the new site is connected.

Step 3 Click **Apply**.



- After the connection is successful, a Wi-Fi connection signal flag appears in the upper-right corner of the live view interface.
- The Wi-Fi module models currently supported are D-LINK, dongle and EW-7811UTC wireless cards.

4.11.4 Wi-Fi AP

Prerequisites

This function requires the built-in Wi-Fi module in the device, and actual product shall prevail.

Background Information

You can configure Wi-Fi parameters for the NVR to ensure that a wireless IPC can connect to the NVR through Wi-Fi AP.

4.11.4.1 General Settings

Background Information

You can configure SSID, encryption type, password and channel of the device.



- This function is supported on select wireless models.
- When the wireless IPC and NVR are matched, the pairing will be completed in 120 seconds after they are powered-on.

Procedure

- Step 1 Select **Main Menu > NETWORK > Wi-Fi AP > General**.
The **General** interface is displayed. See Figure 4-224.

Figure 4-224

The screenshot shows a configuration window with two tabs: 'General' (selected) and 'Advanced'. Under the 'General' tab, the following settings are visible:

- Wi-Fi:
- SSID: DAP-H6TG4...
- Hide SSID:
- Encryption Type: WPA2 PSK (dropdown)
- Password: 7954170d19...
- Select Channel: 6 (dropdown)
- Network Proxy:

At the bottom of the window, there are three buttons: 'Default', 'Apply', and 'Cancel'.

Step 2 Select **Wi-Fi** to enable Wi-Fi.

Step 3 Configure parameters. For details, see Table 4-68.

Table 4-68

Parameter	Description
SSID	Wi-Fi name for the device.
Hide SSID	You can hide the Wi-Fi name when select this option.
Encryption Type	Select an encryption mode. The device provides WPA2 PSK and WPA PSK.
Password	Set the Wi-Fi password for the device.
Select Channel	Select the channel for device communication.
Network Proxy	Enables the external network access through the device for a wireless IPC.

4.11.4.2 Advanced Settings

Background Information



This function is supported on select wireless models.

You can configure IP address, subnet mask, default gateway, DHCP server of the device.

Procedure

- Step 1** Select **Main Menu > NETWORK > Wi-Fi AP > Advanced**.
The **Advanced** interface is displayed. See Figure 4-225.

Figure 4-225

The screenshot shows a configuration window with two tabs: 'General' and 'Advanced'. The 'Advanced' tab is selected. Under the 'IP Config' section, there are input fields for IP Address, Subnet Mask, and Default Gateway. Below that is the 'DHCP Server' section with fields for Start IP, End IP, Preferred DNS, and Alternate DNS. At the bottom of the window are three buttons: 'Default', 'Apply', and 'Cancel'.

- Step 2** Configure parameters. For details, see Table 4-69.

Table 4-69

Parameter	Description
IP Address	Set IP address, subnet mask and default gateway for the Wi-Fi parameters of NVR.
Subnet Mask	
Default Gateway	<p>IP address and default gateway must be in the same network segment.</p>
Start IP	Set the start IP address and end IP address of the DHCP server.
End IP	

Parameter	Description
Preferred DNS	Set preferred/alternate DNS server of the DHCP server.
Alternate DNS	

Step 3 Click **Apply** to complete the configuration.

4.11.5 3G/4G

Prerequisites

Make sure that 3G/4G module is installed on the device.

Background Information



This function is supported on select models.

Procedure

Step 1 Select **Main Menu > NETWORK > 3G/4G**

Figure 4-226

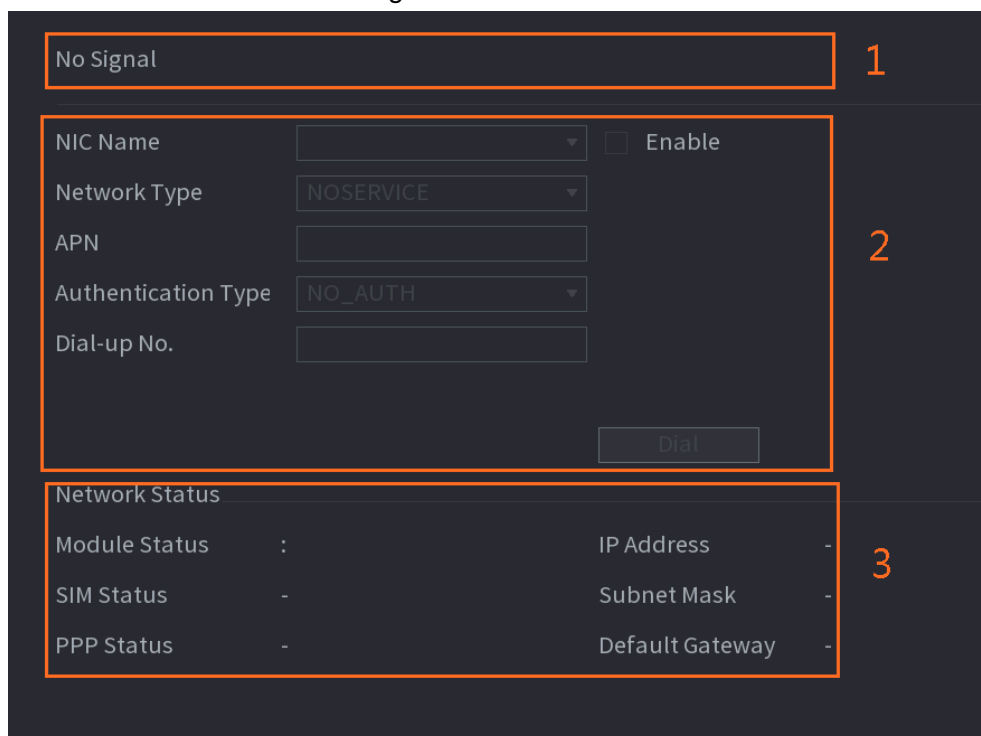

The interface is divided into three main areas:

- Zone 1 displays a 3G/4G signal indication.
- Zone 2 displays 3G/4G module configuration information.
- Zone 3 displays the status information of the 3G/4G module.



Zone 2 displays the corresponding information when the 3G/4G module is connected, while Zone 1 and Zone 3 will only display the corresponding content when the 3G/4G is enabled.

Step 2 Configure Parameters.

Table 4-70

Parameter	Description
NIC Name	Select a NIC name.
Network Type.	Select a 3G/4G network type to distinguish between 3G/4G modules from different vendors.
APN, Dial-up No.	Main parameters of PPP dial.
Authentication Type	Select PAP, CHAP or NO_AUTH. NO_AUTH represents no authentication for 3G/4G.

4.11.6 Cellular Network

Cellular network makes it convenient to allocate an NVR in a place without fixed line broadband.

Prerequisites

A SIM card is inserted in the recorder.



This function is supported on select models.

Procedure

Step 1 Select **Main Menu > NETWORK > Cellular Network > Cellular Network**.

Step 2 Enable cellular network and configure parameters.

Figure 4-227 Configuring cellular network

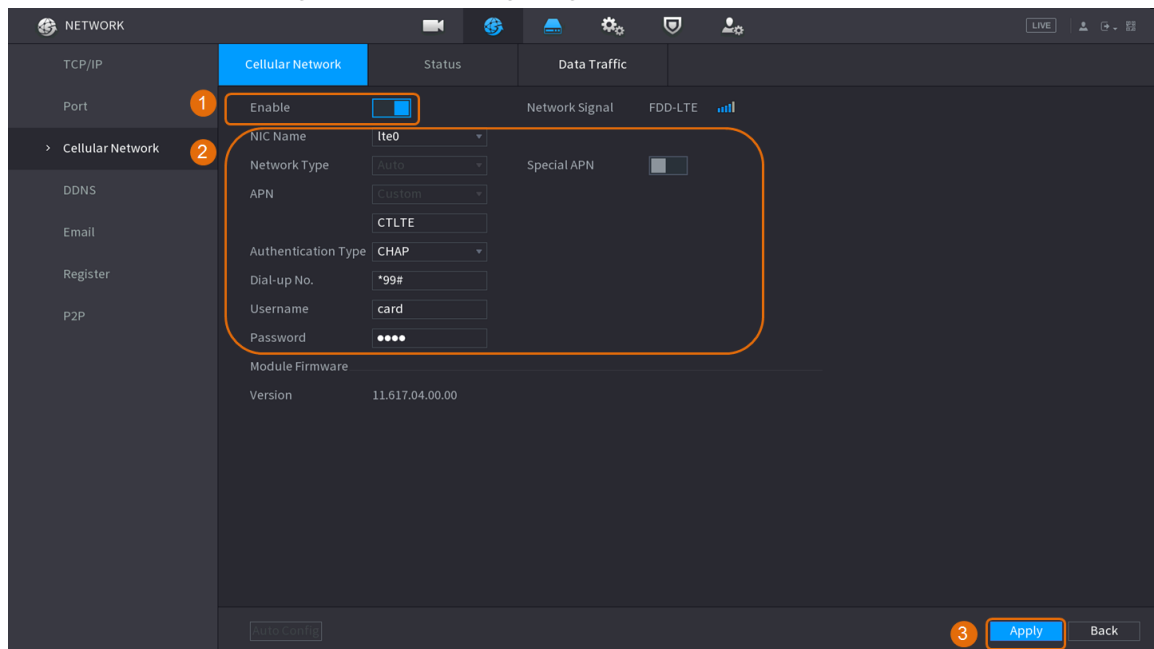

Table 4-71 4G cellular network parameters

Parameter	Description
NIC Name	Select a NIC.
Network Type	Select a network from the SIM card provider.
APN, Dial-up No.	The two main parameters of PPP dial-up connection.

Parameter	Description
Authentication Type	Select PAP , CHAP or NO-AUTH .
Username	The username for dial-up connection.
Password	The password for dial-up connection.

Step 3 Click **Apply**.

Related Operations

Network Status

In **Status** tab, you can check cellular network status such as IP address, SIM card status and dial-up status.

Figure 4-228 Network status

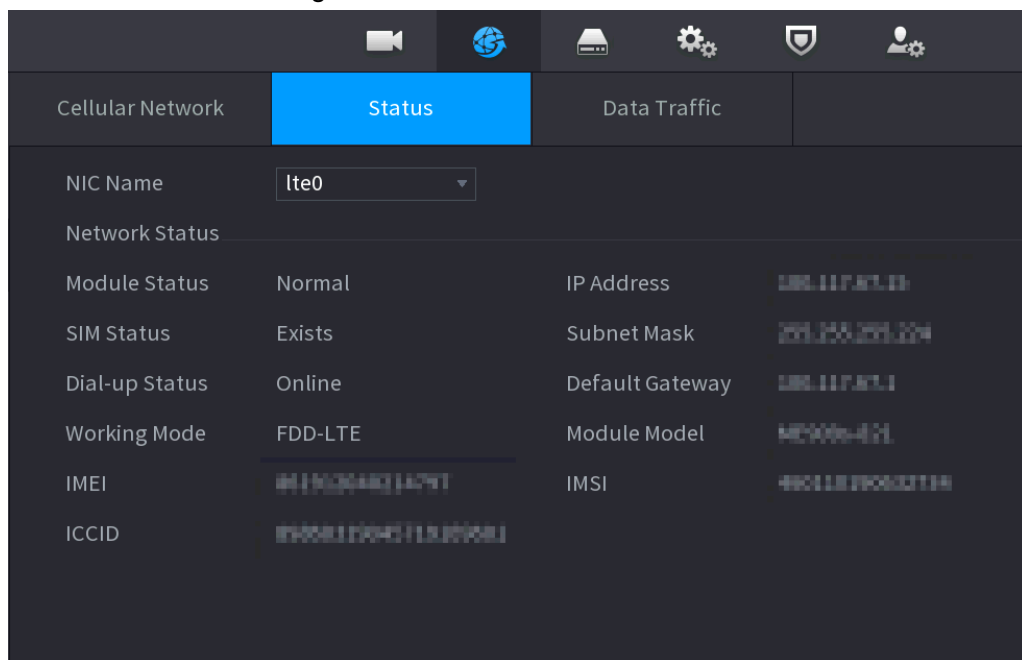

Data Traffic

In **Data Traffic** tab, you can find daily and monthly data usage.

Figure 4-229 Cellular data usage

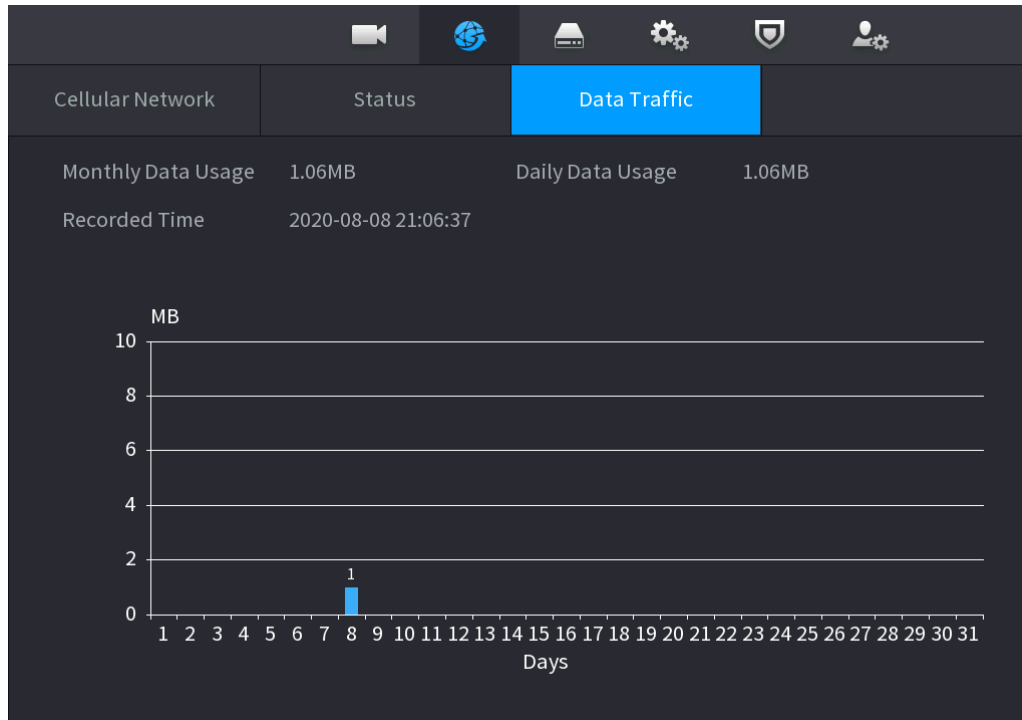

4.11.7 Repeater

The device supports relay settings for the wireless relay IPC to extend video transmission distance and range.

Prerequisites

- The device has the built-in Wi-Fi module.
- The IPC has wireless relay module.



This function is supported on select models.

Procedure

- Step 1** Power on the NVR and wireless relay IPC, and connect all IPCs to the NVR through Wi-Fi.
- Step 2** Select **Main Menu > NETWORK > REPEATER**.
The **REPEATER** interface is displayed. See Figure 4-230.



- Green connection line represents the successful connection between channel and wireless IPC.
- Auto cascade: After selecting auto cascade, the IPC can cascade to NVR automatically.

Figure 4-230



Step 3 Select **Manual Cascade**.

The **Manual Cascade** interface is displayed. See Figure 4-231.



Manual cascade: You can use manual cascade when there are 2 IPCs in the network at least.

Figure 4-231

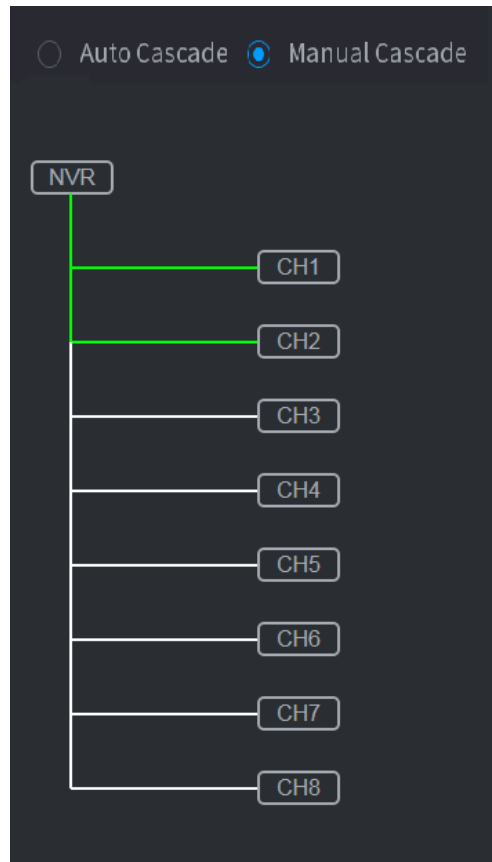

Step 4 Click and select the channel to be added.
The following interface is displayed after successful adding. See Figure 4-232.

Figure 4-232

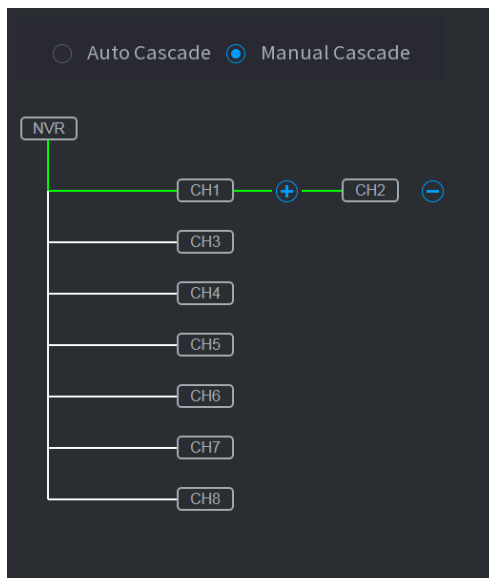

4.11.8 PPPoE

Background Information

PPPoE is another way for the Device to access the network. You can establish network connection by configuring PPPoE settings to give the Device a dynamic IP address in the WAN. To use this function, firstly you need to obtain the user name and password from the Internet Service Provider.

Procedure

- Step 1 Select **Main Menu > NETWORK > PPPoE**.
The **PPPoE** interface is displayed. See Figure 4-233.

Figure 4-233

- Step 2 Enable the PPPoE function.
- Step 3 In the **User Name** box and **Password** box, enter the user name and password accordingly provided by the Internet Service Provider.
- Step 4 Click **Apply** to complete the settings.
The system pops up a message to indicate the successfully saved. The IP address

appears on the PPPoE interface. You can use this IP address to access the Device.



When the PPPoE function is enabled, the IP address on the **TCP/IP** interface cannot be modified.

4.11.9 DDNS

When the IP address of the Device changes frequently, the DDNS function can dynamically refresh the correspondence between the domain on DNS and the IP address, ensuring you access the Device by using the domain.

Background Information

Ensure the Device supports the DDNS Type and log in the website provided by the DDNS service provider to register the information such as domain from PC located in the WAN.



After you have registered and logged in the DDNS website successfully, you can view the information of all the connected devices under this user name.

Procedure

- Step 1** Select **Main Menu > NETWORK > DDNS**.
The **DDNS** interface is displayed. See Figure 4-234.

Figure 4-234

- Step 2** Configure the settings for the DDNS parameters. See Table 4-72.

Table 4-72

Parameter	Description
Enable	Enable the DDNS function. After enabling DDNS function, the third-party might collect your Device information.
Type	Type and address of DDNS service provider.

Parameter	Description
Server Address	<ul style="list-style-type: none"> Type: Dyn dns DDNS; address: members.dyndns.org Type: NO-IP DDNS; address: dynupdate.no-ip.com Type: CN99 DDNS; address: members.3322.org
Domain Name	The domain name for registering on the website of DDNS service provider.
User Name	Enter the user name and password obtained from DDNS service provider. You need to register (including user name and password) on the website of DDNS service provider.
Password	
Interval	Enter the amount of time that you want to update the DDNS.

Step 3 Click **Apply** to complete the settings.

Enter the domain name in the browser on your PC, and then press **Enter**.

If the web interface of the Device is displayed, the configuration is successful. If not, the configuration is failed.

4.11.10 UPnP

You can map the relationship between the LAN and the WAN to access the Device on the LAN through the IP address on the WAN.

4.11.10.1 Configuring Router

Procedure

Step 1 Log in to the router to set the WAN port to enable the IP address to connect into the WAN.

Step 2 Enable the UPnP function on the router.

Step 3 Connect the Device with the LAN port on the router to connect into the LAN.

Step 4 Select **Main Menu > NETWORK > TCP/IP**, configure the IP address into the router IP address range, or enable the DHCP function to obtain an IP address automatically.

4.11.10.2 Configuration UPnP

Procedure

Step 1 Select **Main Menu > NETWORK > UPnP**.

The UPnP interface is displayed. See Figure 4-235. Figure 4-235



6	Service Name	Protocol	Internal...	Externa...	Modify
1	HTTP	TCP	80	80	
2	TCP	TCP	37777	37777	
3	UDP	UDP	37778	37778	
4	RTSP	UDP	554	554	
5	RTSP	TCP	554	554	
6	HTTPS	TCP	443	443	

Figure 4-236

Step 2 Configure the settings for the UPnP parameters. See Table 4-73.

Table 4-73

Parameter	Description
Port Mapping	Enable the UPnP function.
Status	Indicates the status of UPnP function. <ul style="list-style-type: none"> ● Offline: Failed. ● Online: Succeeded.
LAN IP	Enter IP address of router on the LAN. After mapping succeeded, the system obtains IP address automatically without performing any configurations.

Parameter	Description
WAN IP	Enter IP address of router on the WAN.  After mapping succeeded, the system obtains IP address automatically without performing any configurations.
Port Mapping List	The settings in port mapping list correspond to the UPnP port mapping list on the router. <ul style="list-style-type: none"> • Service Name: Name of network server. • Protocol: Type of protocol. • Internal Port: Internal port that is mapped on the Device. • External Port: External port that is mapped on the router.  <ul style="list-style-type: none"> • To avoid the conflict, when setting the external port, try to use the ports from 1024 through 5000 and avoid popular ports from 1 through 255 and system ports from 256 through 1023. • When there are several devices in the LAN, properly arrange the ports mapping to avoid mapping to the same external port. • When establishing a mapping relationship, ensure the mapping ports are not occupied or limited. • The internal and external ports of TCP and UDP must be the same and cannot be modified. • Click  to modify the external port.

Step 3 Click **Apply** to complete the settings.

In the browser, enter `http://WAN IP: External IP port`. You can visit the LAN Device.

4.11.11 Email

Background Information

You can configure the email settings to enable the system to send the email as a notification when there is an alarm event occurs.

Procedure

Step 1 Select **Main Menu > NETWORK > Email**.



The **Email** interface is displayed. See Figure 4-237.

Figure 4-237

Step 2 Configure the settings for the email parameters. See Table 4-74.

Table 4-74

Parameter	Description
Enable	Enable the email function.
SMTP Server	Enter the address of SMTP server of sender's email account.
Port	Enter the port value of SMTP server. The default value setting is 25. You can enter the value according to your actual situation.
Username	Enter the username and password of sender's email account.
Password	
Anonymous	If enable the anonymity function, you can login as anonymity.
Receiver	In the Receiver list, select the number of receiver that you want to receive the notification. The Device supports up to three mail receivers.
Email Address	Enter the email address of mail receiver(s).
Sender	Enter the sender's email address. It supports maximum three senders separated by comma.
Subject	Enter the email subject. Supports Chinese, English and Arabic numerals. It supports maximum 64 characters.
Attachment	Enable the attachment function. When there is an alarm event, the system can attach snapshots as an attachment to the email.

Parameter	Description
Encryption Type	Select the encryption type: NONE , SSL , or TLS .  For SMTP server, the default encryption type is TLS .
Interval (Sec.)	This is the interval that the system sends an email for the same type of alarm event, which means, the system does not send emails caused by frequent alarm events. The value ranges from 0 to 3600. 0 means that there is no interval.
Health Mail	Enable the health test function. The system can send a test email to check the connection.
Sending Interval	This is the interval that the system sends a health test email. The value ranges from 30 to 1440. 0 means that there is no interval.
Test	Click Test to test the email sending function. If the configuration is correct, the receiver's email account will receive the email.  Before testing, click Apply to save the settings.

Step 3 Click **Apply** to complete the settings.

4.11.12 SNMP

You can connect the Device with some software such as MIB Builder and MG-SOFT MIB Browser to manage and control the Device from the software.

Prerequisites

- Install the software that can manage and control the SNMP, such as MIB Builder and MG-SOFT MIB Browser
- Obtain the MIB files that correspond to the current version from the technical support.



This function is for some series only.

Procedure

- Step 1 Select **Main Menu > NETWORK > SNMP**.
 The SNMP interface is displayed. See Figure 4-238.

Figure 4-238

Step 2 Configure the settings for the SNMP parameters. See Table 4-75.

Table 4-75

Parameter	Description
Enable	Enable the SNMP function.
Version	Select the check box of SNMP version(s) that you are using.  The default version is V3 . There is a risk of select V1 or V2.
SNMP Port	Indicates the monitoring port on the agent program.
Read Community	Indicates the read/write strings supported by the agent program.
Write Community	
Trap Address	Indicates the destination address for the agent program to send the Trap information.
Trap Port	Indicates the destination port for the agent program to send the Trap information.
Read-Only Username	Enter the user name that is allowed to access the Device and has the "Read Only" permission.
Read/Write Username	Enter the user name that is allowed to access the Device and has the "Read and Write" permission.
Authentication Type	Includes MD5 and SHA. The system recognizes automatically.

Parameter	Description
Authentication Password/Encryption Password	Enter the password for authentication type and encryption type. The password should be no less than eight characters.
Encryption Type	In the Encryption Type list, select an encryption type. The default setting is CBC-DES.

Step 3 Compile the two MIB files by MIB Builder.

Step 4 Run MG-SOFT MIB Browser to load in the module from compilation.

Step 5 On the MG-SOFT MIB Browser, enter the Device IP that you want to manage, and then select the version number to query.

Step 6 On the MG-SOFT MIB Browser, unfold the tree-structured directory to obtain the configurations of the Device, such as the channels quantity and software version.

4.11.13 Multicast

Background Information

When you access the Device from the network to view the video, if the access is exceeded, the video will not display. You can use the multicast function to group the IP to solve the problem.

Procedure

Step 1 Select **Main Menu > NETWORK > Multicast**.
The **MULTICAST** interface is displayed. See Figure 4-239.

Figure 4-239

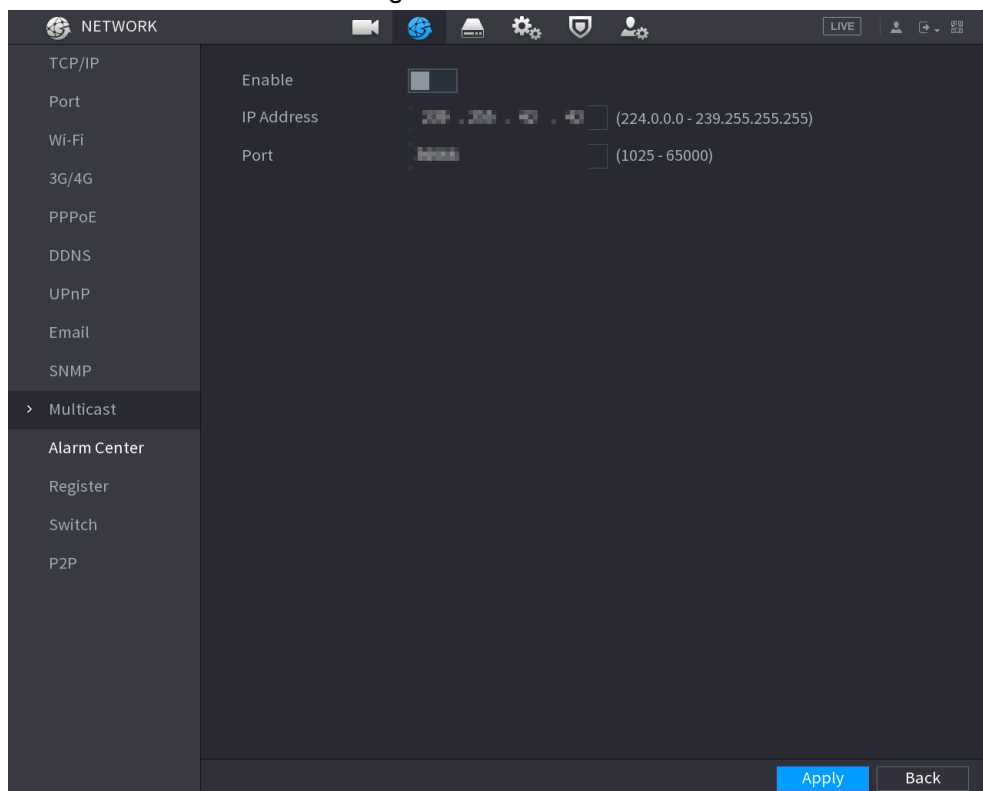

Step 2 Configure the settings for the multicast parameters. See Table 4-76.

Table 4-76

Parameter	Description
Enable	Enable the multicast function.
IP Address	Enter the IP address that you want to use as the multicast IP. The IP address ranges from 224.0.0.0 through 239.255.255.255.
Port	Enter the port for the multicast. The port ranges from 1025 through 65000.

Step 3 Click **Apply** to complete the settings.

You can use the multicast IP address to login the web.

On the web login dialog box, in the **Type** list, select **MULTICAST**. The web will automatically obtain the multicast IP address and join. Then you can view the video through multicast function.

4.11.14 Alarm Center

Background Information

You can configure the alarm center server to receive the uploaded alarm information. To use this function, the **Alarm Upload** check box must be selected.

Procedure

Step 1 Select **Main Menu > NETWORK > Alarm Center**.

The **Alarm Center** interface is displayed. See Figure 4-240.

Figure 4-240

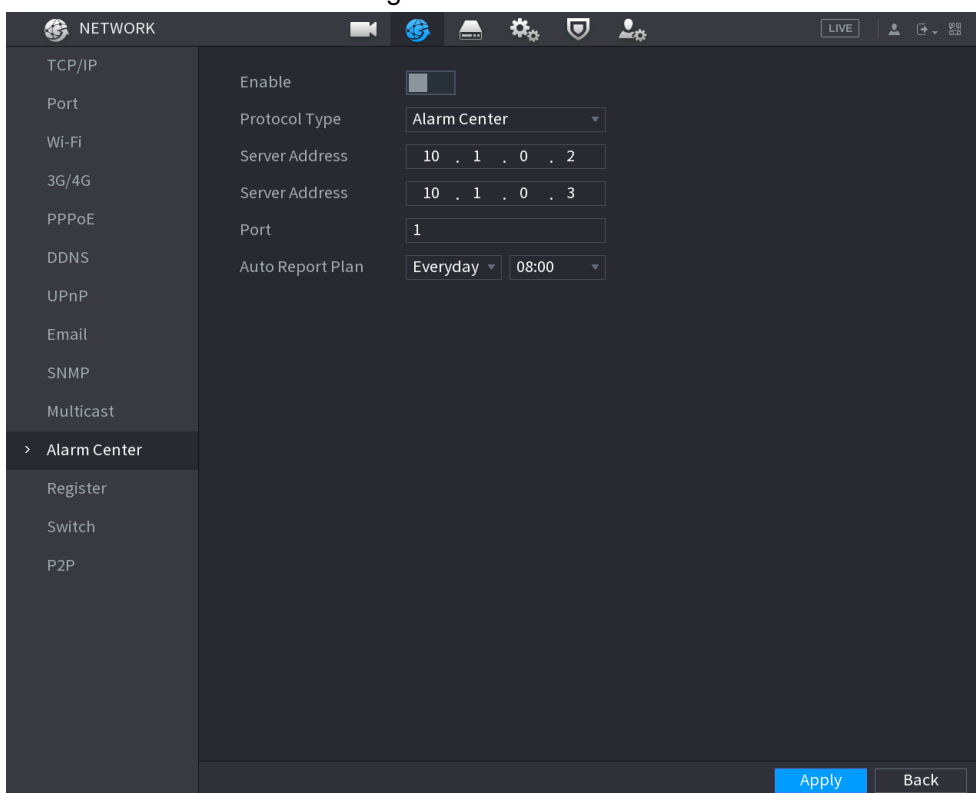

Step 2 Configure the settings for the alarm center parameters. See Table 4-77.

Table 4-77

Parameter	Description
Enable	Enable the alarm center function.
Protocol Type	In the Protocol Type list, select protocol type. The default is Alarm Center .
Host IP	The IP address and communication port of the PC installed with alarm client.
Port	
Auto Report Plan	In the Auto Report Plan list, select time cycle and specific time for uploading alarm.

Step 3 Click **Apply** to complete the settings.

4.11.15 Register

Background Information

You can register the Device into the specified proxy server which acts as the transit to make it easier for the client software to access the Device.

Procedure

Step 1 Select **Main Menu > NETWORK > Register**.
The **Register** interface is displayed. See Figure 4-241.

Figure 4-241

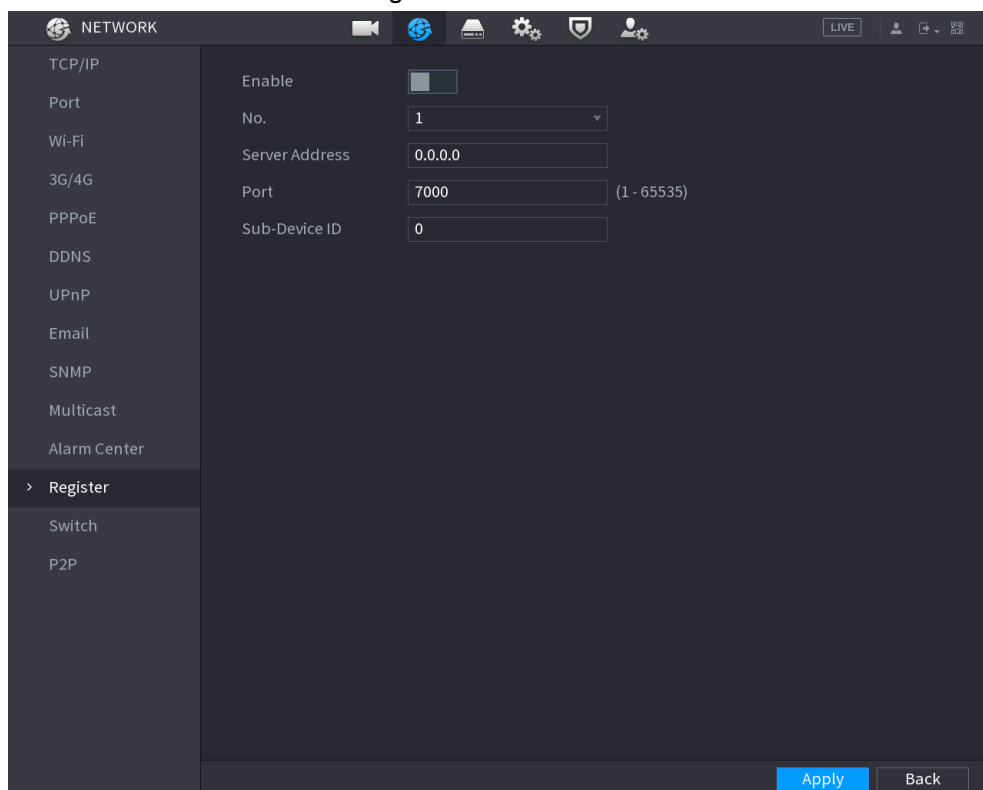

Step 2 Configure the settings for the register parameters. See Table 4-78.

Table 4-78

Function	Description
Enable	Enable the register function.
Server IP Address	Enter the server IP address or the server domain that you want to register to.
Port	Enter the port of the server.
Sub Service ID	This ID is allocated by the server and used for the Device.

Step 3 Click **Apply** to complete the settings.

4.11.16 Setting Switch

Background Information

After setting **Switch**, when an IPC is connected to the PoE port, the system automatically assigns the IP address to the IPC according to the set IP segment, and the NVR will automatically connect to the IPC.



- Only models with PoE ports support this function.
- Do not connect the PoE port with a switch, otherwise it will cause connection failure.
- This function is enabled by default, and the IP segment start from 10.1.1.1, we recommend that you use the default setting.
- When connecting to a third-party IPC, make sure that the IPC supports Onvif protocol and DHCP is enabled.

Procedure

Step 1 Select **Main Menu > Network > Switch**.

Figure 4-242

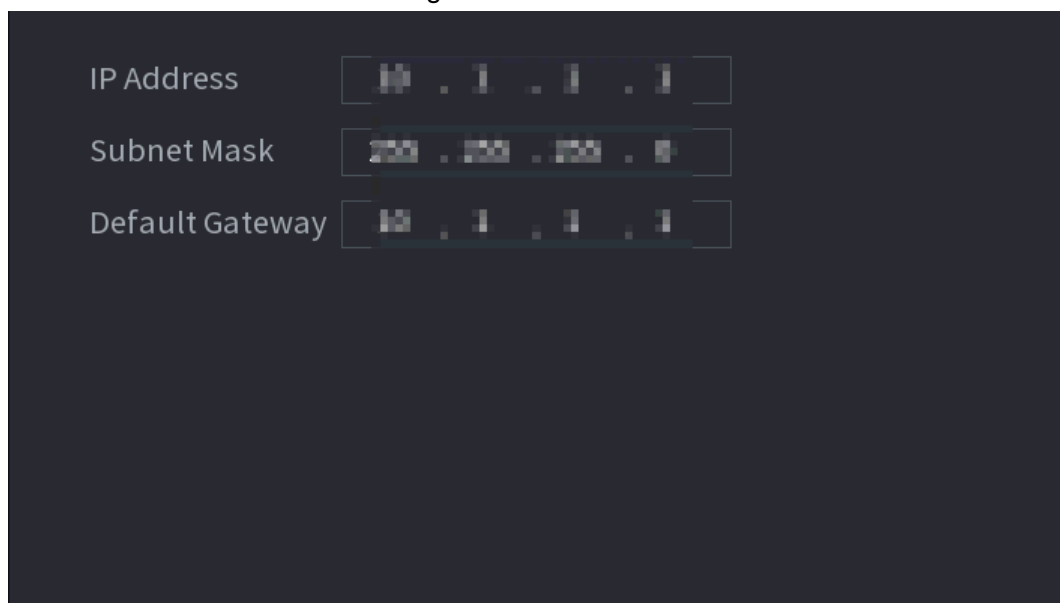

Step 2 Set the values of **IP Address**, **Subnet Mask** and **Default Gateway**.

Do not set the value of **IP Address** to the same network segment with the NVR, we recommend that you use the default setting.

Step 3 Click **Apply**.

PoE Port Description

Table 4-79

PoE Status	Description
Connect to PoE port	<p>When an IPC is connected to the PoE port, the system automatically assigns the IP address to the IPC according to the set IP segment. The NVR will try the method of arp ping to assign the IP address. If DHCP is enabled on the NVR, the NVR will use DHCP to assign the IP address.</p> <ul style="list-style-type: none"> When IP address is successfully set, the system will broadcast through Switch. If there is a response from the IPC, it means the connection is successful, and the NVR will log in with the IPC. You can find the corresponding channel being occupied and there is an PoE icon at the upper-left corner. You can also view PoE status such as channel number and PoE port number in Main Menu > CAMERA > Camera List > Added Device
Disconnect PoE port	<p>When an IPC is disconnected from PoE port, you will find the information of Failed to find network host on the Live View interface.</p>
PoE connection mapping	<p>The PoE ports are bound to corresponding channels. When an IPC is connected to PoE port 1, the corresponding channel is Channel 1.</p>

4.11.17 P2P

Background Information

P2P is a kind of convenient private network penetration technology. You do not need to apply for dynamic domain name, doing port mapping or deploying transit server. You can add NVR devices through the below way to achieve the purpose of managing multiple NVR devices at the same time.

- Scan the QR code, download mobile app, and then register an account. For details, see [Mobile App Operation](#).
- Log in to www.gotop2p.com, register an account, and then add device via the serial number. For details, see [Introduction of P2P Operations](#).



Connect the NVR device to the Internet, otherwise P2P can not run properly.

Procedure

Step 1 Select **Main Menu > NETWORK > P2P**.

The **P2P** interface is displayed. See Figure 4-243.

Figure 4-243

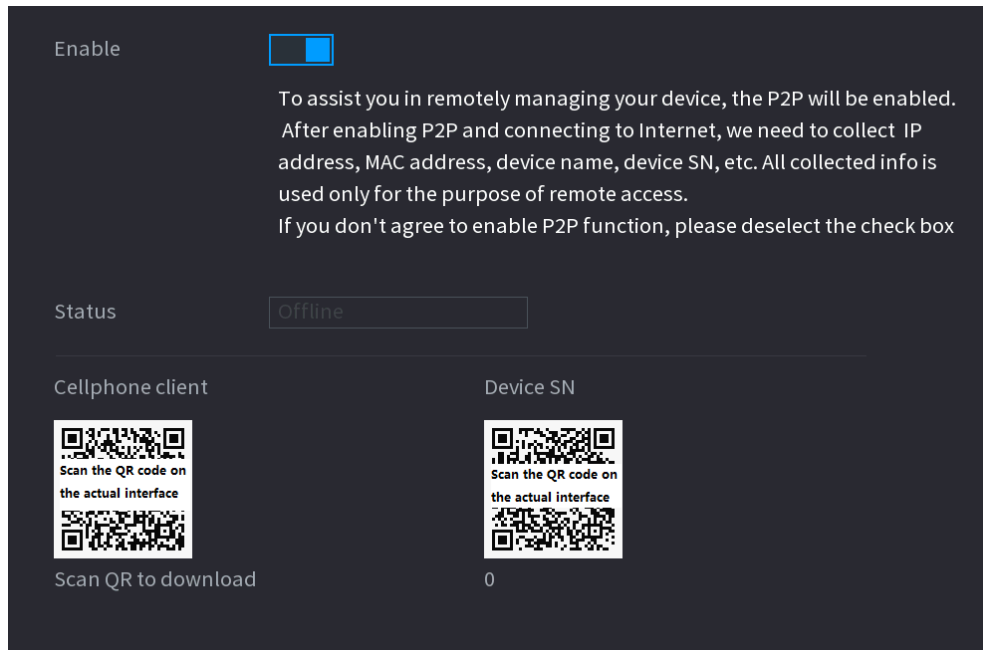

Step 2 Enable the P2P function.



After the P2P function is enabled and connected to the Internet, the system will collect your information for remote access, and the information includes but not limited to email address, MAC address, and device serial number.

You can start adding the device.

- Cell Phone Client: Use your mobile phone to scan the QR code to add the device into the Cell Phone Client, and then you can start accessing the Device.
- Platform: Obtain the Device SN by scanning the QR code. Go to the P2P management platform and add the Device SN into the platform. Then you can access and manage the device in the WAN. For details, refer to the P2P operation manual.



You can also enter the QR code of Cell Phone Client and Device SN by clicking  on the top right of the interfaces after you have entered the Main Menu.

4.11.17.1 Mobile APP Operation

Background Information

The following contents are introduced in the example of mobile App.

Procedure

- Step 1** Scan the QR code to download and install the mobile App.
- Step 2** Select Camera and enter the main interface.
- Step 3** Register device in the mobile App:
- 1) Click  and select Device Manager. See Figure 4-244.

Figure 4-244



- 2) Click **+** and enter the Add Device interface.

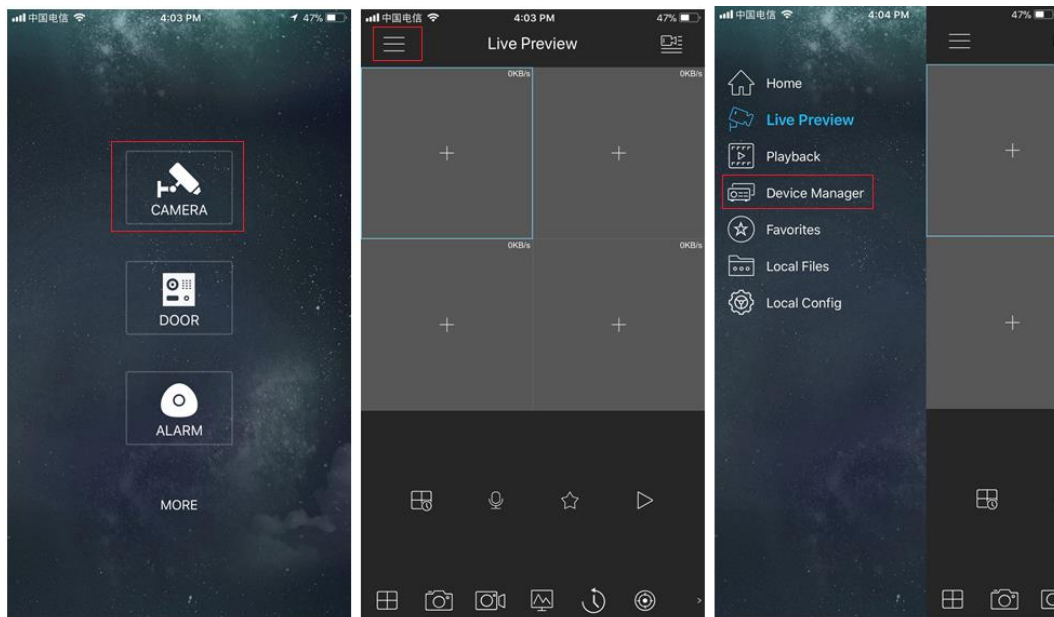

Mobile App supports device initialization.

- 3) Select **Wired Device > P2P** to enter the P2P interface.
- 4) Click the QR code icon behind the SN to enter the QR code scan interface.
- 5) Scan the device label or scan the SN QR code got by selecting **Main Menu > Network > P2P**. When the scan is successful, the device SN will be displayed in the SN item.
- 6) Enter name and password.

Step 4 After device registration on mobile App, click Start Preview and you can see the monitor screen.

4.12 Storage

You can manage the storage resources (such as record file) and storage space. So that it is easy for you to use and enhance storage space usage.

4.12.1 Basic

Background Information

You can set basic storage parameters.

Procedure

- Step 1** Select **Main Menu > STORAGE > BASIC**.
The Basic interface is displayed. See Figure 4-245.

Figure 4-245

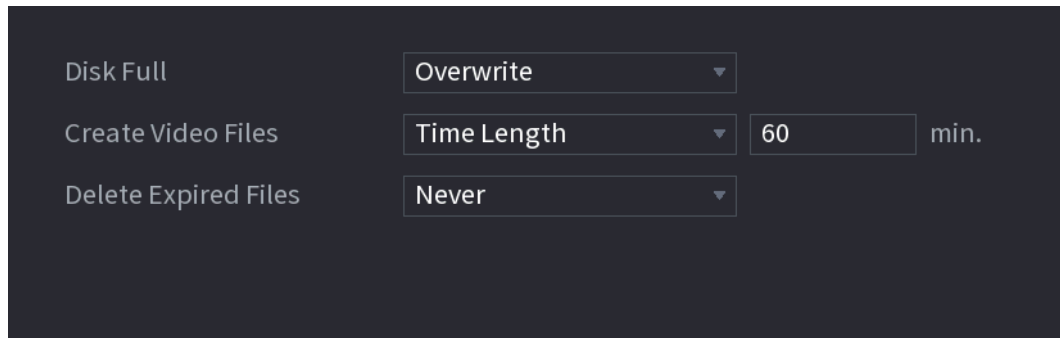

Step 2 Set parameters. See Table 4-80.

Table 4-80

Parameter	Description
Disk Full	Configure the settings for the situation all the read/write discs are full, and there is no more free disc. <ul style="list-style-type: none"> • Select Stop Record to stop recording • Select Overwrite to overwrite the recorded video files always from the earliest time.
Create Video Files	Configure the time length and file length for each recorded video.
Delete Expired Files	Configure whether to delete the old files and if yes, configure the days.  Deleted files cannot be recovered!

Step 3 Click **Apply** or **Save** to complete setup.

4.12.2 Schedule

You can set schedule record and schedule snapshot. NVR can record or snapshot as you specified. For detailed information, refer to "4.1.4.6.1 Recording Schedule" and "4.1.4.6.2 Snapshot Schedule".

4.12.3 Disk Manager

Background Information

You can view and sett HDD properties and format HDD.

You can view current HDD type, status, capacity and etc. The operation includes format HDD, and change HDD property (read and write/read-only/redundancy).

- To prevent files be overwritten in the future, you can set HDD as read-only.
- To backup recorded video file, you can set HDD as redundant HDD.

Procedure

Step 1 Select **Main Menu > Storage > Disk Manager**.

The **Disk Manager** interface is displayed. See Figure 4-246.

Figure 4-246

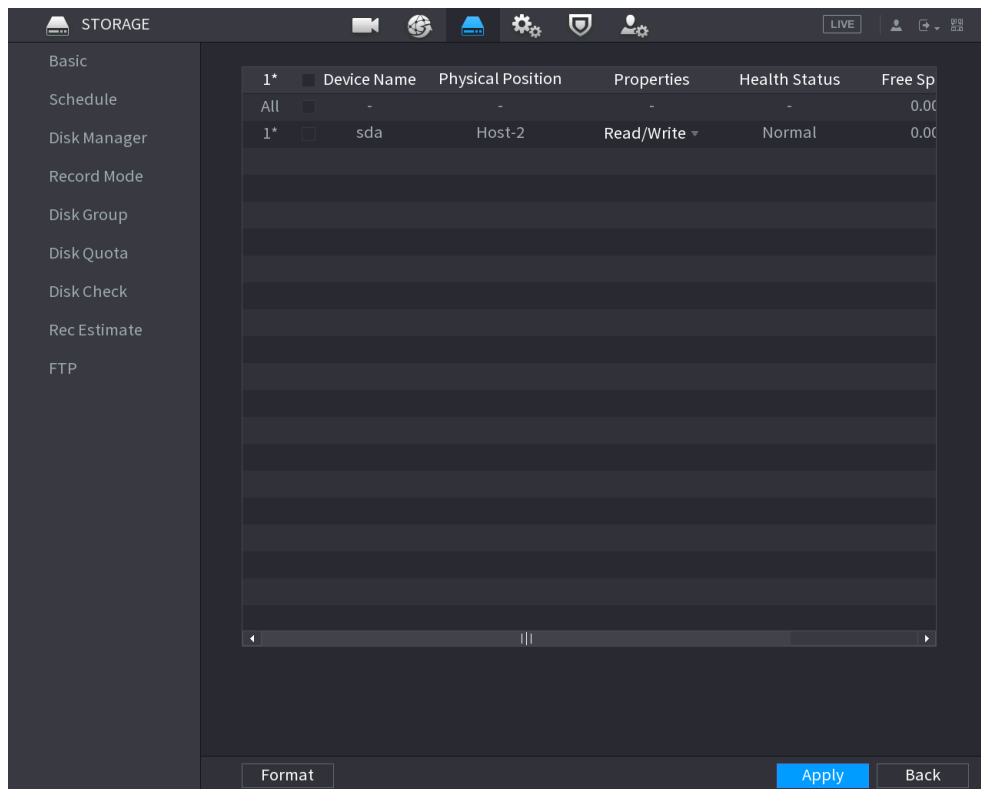

Step 2 Select a HDD and then select a time from the drop-down list.

Step 3 (Optional) Format a HDD.

- 1) Select a HDD and then click **Format**.
- 2) Click **OK**.
- 3) Enter the admin password and click **OK**.



- This operation will erase all data in the HDD, proceed with caution.
- If xxx is selected, database will also be cleaned.

Step 4 Click **Apply** button to complete the setup. System needs to restart to activate current setup if you want to format the HDD.

4.12.4 Record Control

After you set schedule record or schedule snapshot function, set auto record/snapshot function so that the NVR can automatically record or snapshot. For detailed information, refer to "4.1.4.6.3 Record Control".

4.12.5 Disk Group

Background Information

By default, the installed HDD and created RAID are in Disk Group 1. You can set HDD group, and HDD group setup for main stream, sub stream and snapshot operation.

Figure 4-248

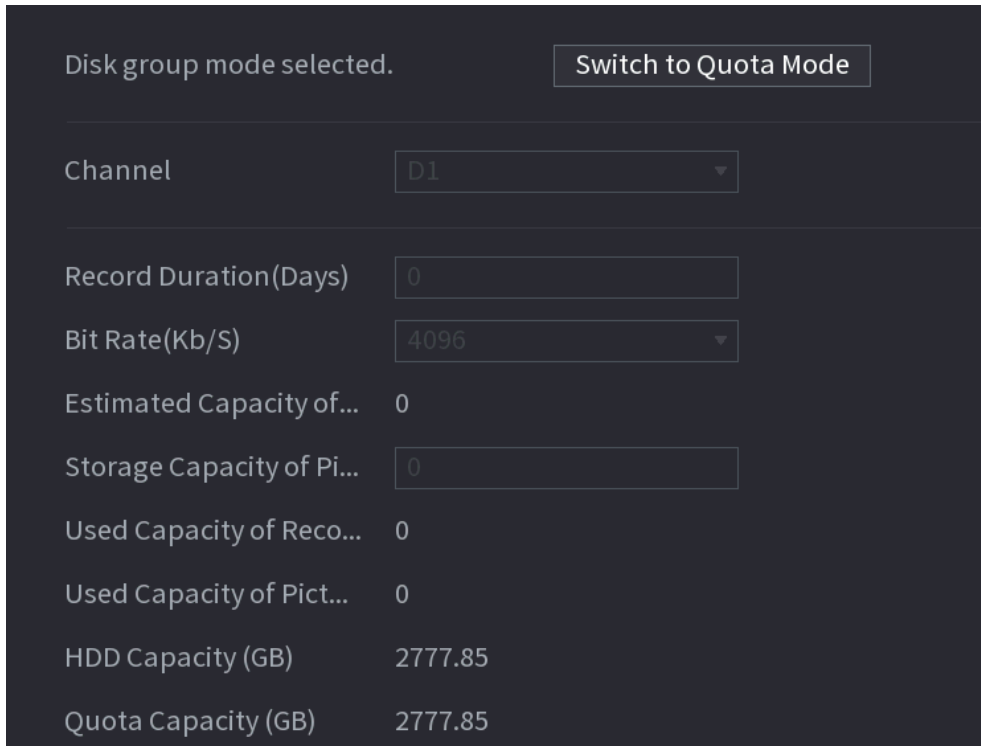

Disk group mode selected.		Switch to Quota Mode
Channel	D1	
Record Duration(Days)	0	
Bit Rate(Kb/S)	4096	
Estimated Capacity of...	0	
Storage Capacity of Pi...	0	
Used Capacity of Reco...	0	
Used Capacity of Pict...	0	
HDD Capacity (GB)	2777.85	
Quota Capacity (GB)	2777.85	

Step 2 Select a channel and set the values of record duration, bit rate and storage capacity of picture.

Step 3 Click **Apply**.

4.12.7 Disk Check

The HDD detect function is to detect HDD current status so that you can clearly understand the HDD performance and replace the malfunction HDD.

There are two detect types:

- Quick detect is to detect via the universal system files. System can quickly complete the HDD scan. If you want to use this function, make sure the HDD is in use now. If the HDD is removed from other device, make sure the HDD once storage the record files when installed on current device.
- Global detect adopts Windows mode to scan. It may take a long time and may affect the HDD that is recording.

4.12.7.1 Manual Check

Procedure

- Step 1** Select **Main Menu > STORAGE > Disk Check > Manual Check**.
The **Manual Check** interface is displayed. See Figure 4-249.

Figure 4-249

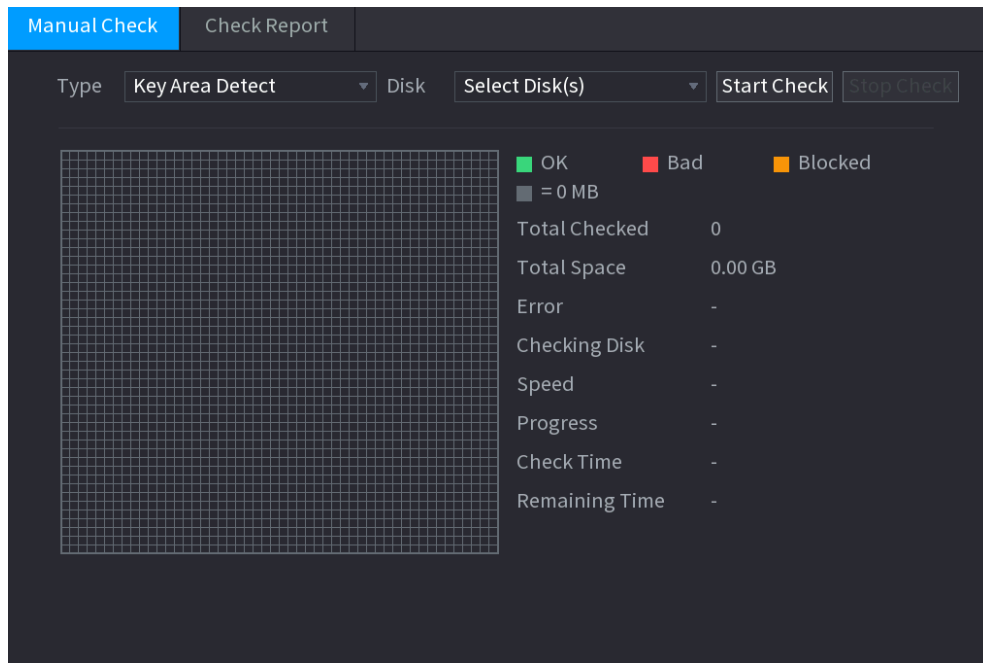

Step 2 In the **Type** list, select **Key Area Detect** or **Global Check**; and in the **Disk** list, select the HDD that you want to detect.

Step 3 Click **Start Check**.

The system starts detecting the HDD and displays the detection information.



When system is detecting HDD, click **Stop Check** to stop current detection. Click **Start Check** to detect again.

4.12.7.2 Detect Report

Background Information

After the detect operation, you can go to the detect report to view corresponding information. Replace the malfunction HDD in case there is data loss.

Procedure

Step 1 Select **Main Menu > STORAGE > Disk Check > Check Report**.

The **Check Report** interface is displayed. See Figure 4-250.

Figure 4-250

1	Disk No.	Check Type	Start Time	Total Space	Er
1	Host-2	Key Area Detect	2020-02-23 18:55:09	2794.52 GB	

Step 2 Click .

The Details interface is displayed. You can view detecting results and S.M.A.R.T reports. See Figure 4-251 and Figure 4-252. Figure 4-251

Details

Results S.M.A.R.T

Type Key Area Detect Export search results.

■ OK ■ Bad ■ Blocked
■ = 1244 MB

Total Checked 1
 Total Space 2794.52 GB
 Error 0
 Disk No. 2

Bad Sector List

No.	Sector No

Figure 4-252

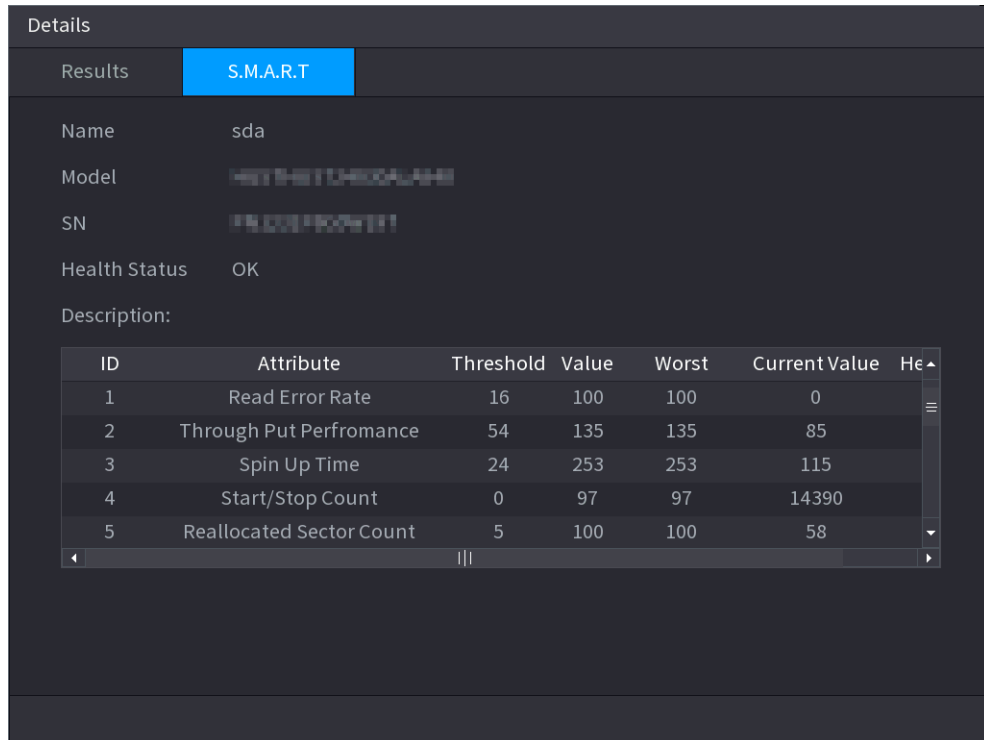

4.12.7.3 Disk Health Monitoring

Monitor health status of disks, and repair if any exceptions are found so as to avoid data loss. Select **Main Menu > STORAGE > Disk Check > Health Monitoring**. Click **i** to show disk details interface. Then select **Check Type**, set time period, and then click **Search**. The interface shows the details of disk monitoring status.

Figure 4-253 Disk details

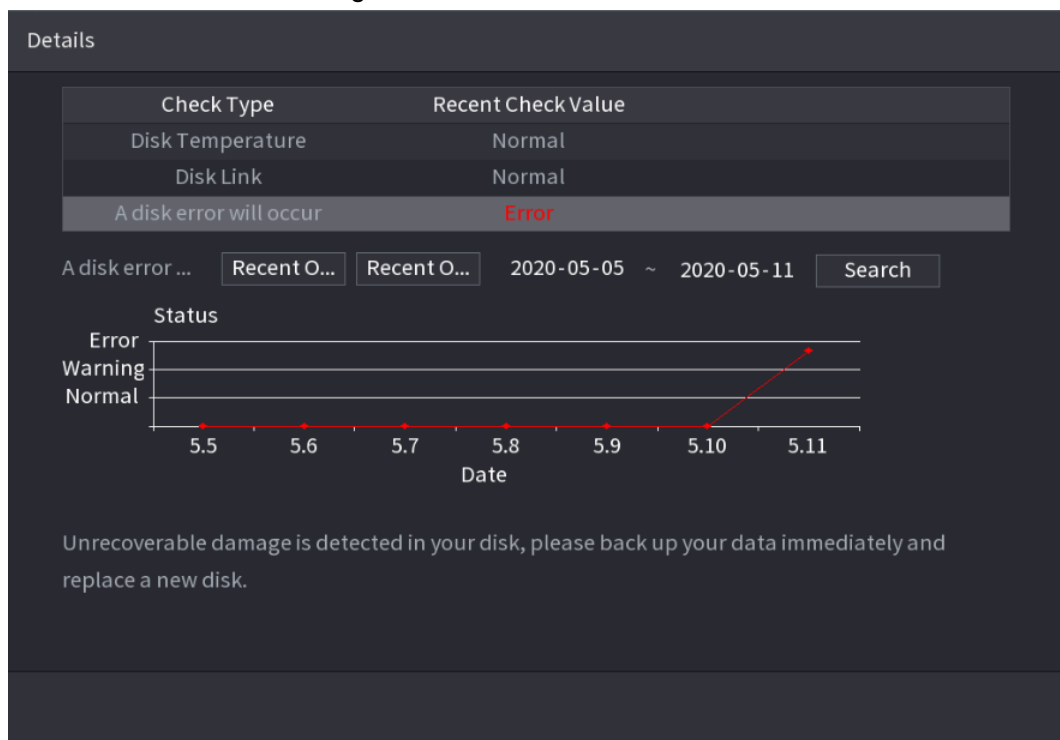

4.12.8 RAID

RAID (redundant array of independent disks) is a data storage virtualization technology that combines multiple physical HDD components into a single logical unit for the purposes of data redundancy, performance improvement, or both.



- RAID function is for some series products only. Slight difference may be found on the user interface.
- The NVR supports RAID0, RAID1, RAID5, RAID6, and RAID 10. Local hot spare supports RAID1, RAID5, RAID6, and RAID10.

For the disk quantity required for each RAID type. See Table 4-81.

Table 4-81

RAID type	Required disk quantity
RAID0	At least 2.
RAID1	Only 2.
RAID5	At least 3, and using 4 disks to 6 disks is recommended.
RAID6	At least 4.
RAID10	

4.12.8.1 Creating Manager

RAID has different levels (such as RAID5, RAID6). Each level has different data protection, data availability, and performance grade.

Background Information

You can manually create RAID or just one click one button to create RAID. For creating RAID function, you can select the physical HDD that does not included in the RAID group or the created disk array to create a RAID5. You can refer to the following situations:



- There is no RAID, no hotspare disk: System directly creates the RAID5 and creates one hotspare disk at the same time.
- There is no RAID, but there is a hotspare disk: System creates the RAID5 only. It uses previous hotspare disk.
- There is RAID: System cancel the previous RAID setup and then create the new RAID5. System creates the hotspare disk if there is no one. System uses previous hotspare disk if there is hotspare disk available.
- The background will format the virtual disk.

You can create different types of RAID as needed.

Procedure

- Step 1 Select **Main Menu > STORAGE > RAID > RAID**.
The RAID interface is displayed. See Figure 4-254.

Figure 4-254

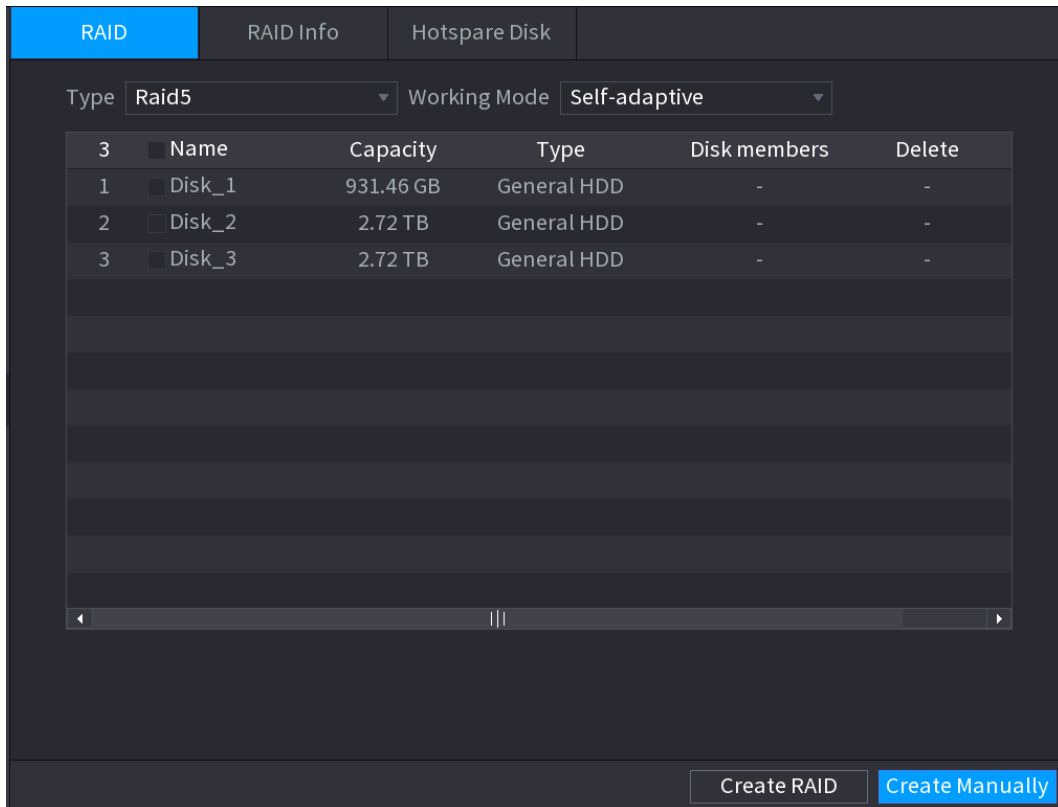

Step 2 You can click **Create RAID** or **Create Manually**, and all the disks involved will be formatted.

- Click **Create RAID**, the system will create RAID automatically.
 - ◇ If there is no existing RAID and no hot spare disk, the system will create RAID5 and a hot spare disk automatically.
 - ◇ If there is no existing RAID, but existing hot spare disk, the system will only create RAID5 and use the existing hot spare disk automatically.
 - ◇ If there is existing RAID and existing hot spare disk, the system will delete the original RAID and create RAID5 with all the disks and use the existing hot spare disk automatically.
- Click **Create Manually**.
 1. Select RAID type and disks as system instructed.
 2. Click **Create Manually**, and then the format disk notice is displayed.
 3. Click **OK**.

Step 3 After creating RAID, the disks need to sync with each other to finish the process. For RAID5 and RAID6, you can select different working mode.

- **Self-Adaptive**: Automatically adjust the RAID sync speed according to the business status.
 - ◇ When there is no business running, sync is performed at a high speed.
 - ◇ When there is business running, sync is performed at a low speed.
- **Sync First**: Resource priority is assigned to RAID sync.
- **Business First**: Resource priority is assigned to business operations.
- **Balance**: Resource is evenly distributed to RAID sync and business operations.

4.12.8.2 Raid Info

You can view the existing RAID information, including type, disk space, hot spare, and status. Select **Main Menu > STORAGE > RAID > RAID Info**.

The RAID Info interface is displayed. See Figure 4-255.

Figure 4-255

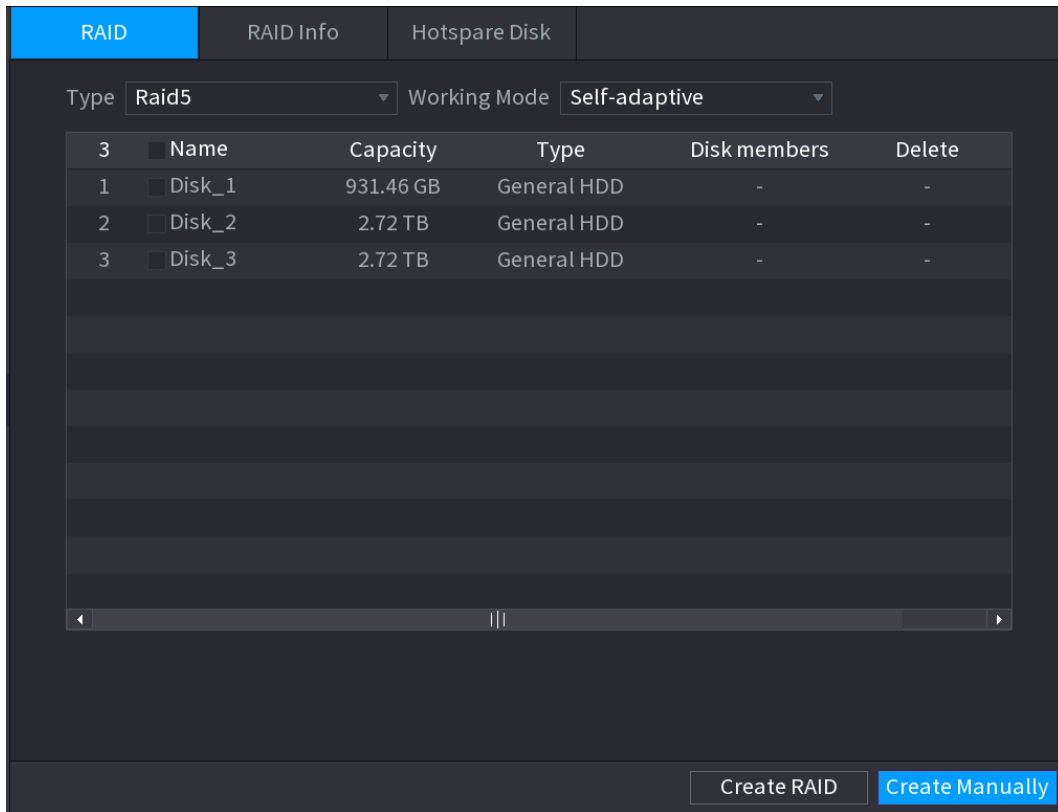

4.12.8.3 Hot Spare Disk



Background Information

You can add a hot spare disk to a specific disk in the RAID or to the entire RAID, and the hot spare disk is switched into operation if any disk fails.

Procedure

- Step 1 Select **Main Menu > STORAGE > RAID > Hotspare Disk**.
The **Hotspare Disk** interface is displayed. See Figure 4-256.

Figure 4-256

RAID	RAID Info	Hotspare Disk				
3	Name	Capacity	Type	RAID Name	Edit	Delete
1	Disk_1	931.46 GB	General HDD	-		-
2	Disk_2	2.72 TB	General HDD	-		-
3	Disk_3	2.72 TB	General HDD	-		-

Step 2 Click the  icon behind a disk.

Step 3 The **New Hotspare** interface is displayed. See Figure 4-257 (New hot spare (local) or Figure 4-258 (New hot spare (global)).

Figure 4-257

New Hotspare

Type Local Hotspare ▼ Add to md0 ▼

OK
Cancel

Figure 4-258

New Hotspare

Type Global Hotspare ▼

OK
Cancel

Step 4 You can select **Local Hotspare** or **Global Hotspare**.

- Local Hotspare: Select the target disk, and the new disk will serve as the hot spare disk of the selected disk.
- Global Hotspare: the new disk will serve as the hot spare disk of the entire RAID.

Step 5 Click **OK**.



Click  behind a hot spare disk to delete it.

4.12.9 Record Estimate

Background Information

Record estimate function can calculate how long you can record video according to the HDD capacity, and calculate the required HDD capacity according to the record period.

Procedure

Step 1 Select Main Menu > STORAGE > Rec Estimate.

The **Rec Estimate** interface is displayed. See Figure 4-259.

Figure 4-259

The screenshot shows the 'STORAGE' menu with 'Rec Estimate' selected. The interface displays a table of recording channels with the following data:

Cha...	Modify	Bit Rate(Kb/S)	Record Time	Resolution	Frame Rate(...)
<input checked="" type="checkbox"/> 1		4096	24	1920x1080(1080P)	25
<input checked="" type="checkbox"/> 2		2048	24	1920x1080(1080P)	25
<input checked="" type="checkbox"/> 3		8192	24	5120x1800(5120x...	25
<input type="checkbox"/> 4		6144	24	2560x1440	25
<input type="checkbox"/> 5		2048	24	720P	25
<input type="checkbox"/> 6		2048	24	720P	25
<input type="checkbox"/> 7		2048	24	720P	25
<input type="checkbox"/> 8		2048	24	720P	25
<input checked="" type="checkbox"/> 9		6144	24	4096x1800(4096x...	25
<input checked="" type="checkbox"/> 10		6144	24	2560x1440(2560x...	25
<input type="checkbox"/> 11		2048	24	720P	25
<input type="checkbox"/> 12		2048	24	720P	25
<input type="checkbox"/> 13		2048	24	720P	25
<input type="checkbox"/> 14		2048	24	720P	25
<input type="checkbox"/> 15		2048	24	720P	25
<input type="checkbox"/> 16		2048	24	720P	25
<input type="checkbox"/> 17		2048	24	720P	25

Below the table, there are two tabs: 'By Space' (selected) and 'By Time'. The 'By Space' tab shows 'Total Space' as 0 TB = 0 GB and a 'Select' button. The 'By Time' tab shows 'Time' as 0 Days. A note at the bottom states: 'Note: The record estimate data is for reference only. Please be cautious when evaluating record period.'

Step 2 Click .

The **Edit** dialogue box is displayed. See Figure 4-260. You can configure the **Resolution**, **Frame Rate**, **Bit Rate** and **Record Time** for the selected channel.

Figure 4-260

Step 3 Click **Apply** to save the settings.

Then the system will calculate the time period that can be used for storage according to the channels settings and HDD capacity.



Click **Copy to** to copy the settings to other channels.

4.12.9.1 Calculating Recording Time

Procedure

Step 1 On the **Rec Estimate** interface, click the **By Space** tab.
The **By Space** interface is displayed. See Figure 4-261.

Figure 4-261

Step 2 Click **Select**.

The **Select HDD(s)** interface is displayed.

Step 3 Select the check box of the HDD that you want to calculate.

In the Known Space tab, in the Time box, the recording time is displayed. See Figure 4-262.

Figure 4-262

4.12.9.2 Calculating HDD Capacity for Storage

Procedure

- Step 1** On the **Rec Estimate** interface, click the **By Time** tab. The **By Time** interface is displayed. See Figure 4-263.

Figure 4-263

- Step 2** In the **Time** box, enter the time period that you want to record. In the **Total Space** box, the required HDD capacity is displayed.

4.12.10 FTP

You can store and view the recorded videos and snapshots on the FTP server.

Background Information

Purchase or download a FTP (File Transfer Protocol) server and install it on your PC.



For the created FTP user, you need to set the write permission; otherwise the upload of recorded videos and snapshots will be failed.

Procedure

- Step 1** Select **Main Menu > STORAGE > FTP**. The **FTP** interface is displayed. See Figure 4-264.

Figure 4-264

Step 2 Configure the settings for the FTP settings parameters. See Table 4-82.

Table 4-82

Parameter	Description
Enable	Enable the FTP upload function.
FTP type	<ul style="list-style-type: none"> • Select FTP type. • FTP: Plaintext transmission. • SFTP: Encrypted transmission (recommended)
Server Address	IP address of FTP server.
Port	<ul style="list-style-type: none"> • FTP: The default is 21. • SFTP: The default is 22.
Anonymous	Enter the user name and password to log in to the FTP server.
User Name	Enable the anonymity function, and then you can login anonymously without entering the user name and password.
Password	

Parameter	Description
Storage Path	Create folder on FTP server. <ul style="list-style-type: none"> • If you do not enter the name of remote directory, system automatically creates the folders according to the IP and time. • If you enter the name of remote directory, the system creates the folder with the entered name under the FTP root directory first, and then automatically creates the folders according to the IP and time.
File Size	Enter the length of the uploaded recorded video. <ul style="list-style-type: none"> • If the entered length is less than the recorded video length, only a section of the recorded video can be uploaded. • If the entered length is more than the recorded video length, the whole recorded video can be uploaded. • If the entered length is 0, the whole recorded video will be uploaded.
Picture Upload Interval	<ul style="list-style-type: none"> • If this interval is longer than snapshot interval, the system takes the recent snapshot to upload. For example, the interval is 5 seconds, and snapshot interval is 2 seconds per snapshot, the system uploads the recent snapshot every 5 seconds. • If this interval is shorter than snapshot interval, the system uploads the snapshot per the snapshot interval. For example, the interval is 5 seconds, and snapshot interval is 10 seconds per snapshot, the system uploads the snapshot every 10 seconds. • To configure the snapshot interval, select Main Menu > CAMERA > Encode > Snapshot.
Channel	Select the channel that you want to apply the FTP settings.
Day	Select the week day and set the time period that you want to upload the recorded files. You can set two periods for each week day.
Period 1, Period 2	
Record type	Select the record type (Alarm, Intel, MD, and General) that you want to upload. The selected record type will be uploaded during the configured time period.

Step 3 Click **Test**.

The system pops up a message to indicate success or failure. If failed, check the network connection or configurations.

Step 4 Click **Apply** to complete the settings.

4.12.11 Setting iSCSI

Background Information

Internet Small Computer Systems Interface (iSCSI) is a transport layer protocol that works on top of the Transport Control Protocol (TCP), and enables block-level SCSI data transport between the iSCSI initiator and the storage target over TCP/IP networks. After the network disk is mapped to the NVR device through iSCSI, the data can be stored on the network disk.



This function is only supported by select models. The actual product shall prevail.

Procedure

Step 1 Select **Main Menu > STORAGE > iSCSI**.

Figure 4-265

No.	Status	IP Address	Port	Username	Storage Path
ISCSI1	×	192.168.1.100	3260	ryl13209	2211

Step 2 Set parameters.

Table 4-83

Parameter	Description
Server Address	Enter the server address of iSCSI server.
Port	Enter the port of iSCSI server, and the default value is 3260.
Storage Path	Click Storage Path to select a remote storage path. Each path represents an iSCSI shared disk and these paths are generated when created on the server
Username, Password	Enter the username and password of iSCSI server. If anonymous login is supported by iSCSI server, you can enable Anonymous to log in as an anonymous user.

Step 3 Click **Apply**.

4.13 System

4.13.1 General

You can set device general information. It includes device information, system date. Refer to "4.1.4.1 General" for detailed information.

4.13.2 Serial Port

Background Information

After setting RS-232 parameters, the NVR can use the COM port to connect to other device to debug and operate.

Procedure

- Step 1 Select **MAIN MENU > SYSTEM > Serial Port**.
- Step 2 The **Serial Port** interface is displayed. See Figure 4-266.

Figure 4-266

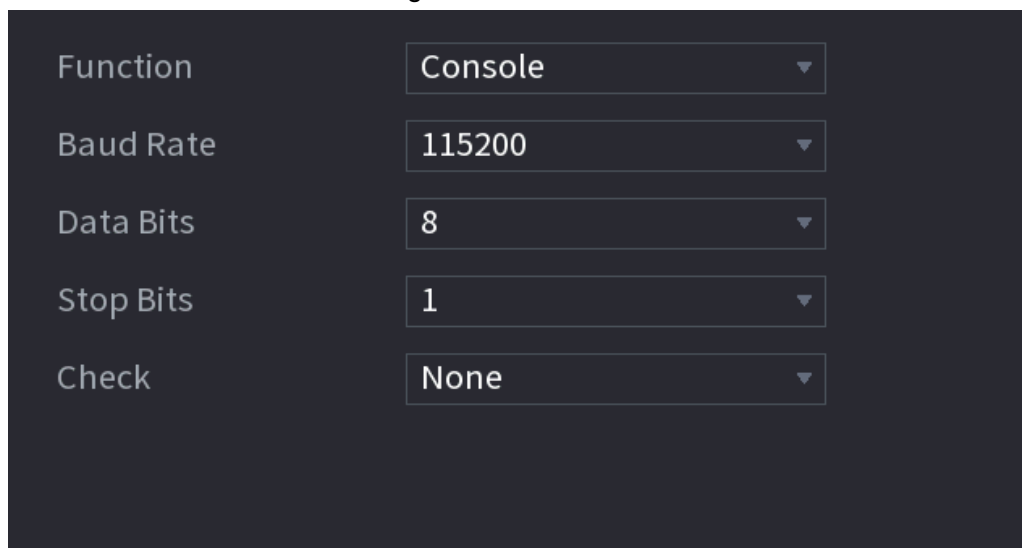

Function	Console
Baud Rate	115200
Data Bits	8
Stop Bits	1
Check	None

- Step 3 Configure parameters. See Table 4-84.

Table 4-84

Parameter	Description
Function	Select serial port control protocol. <ul style="list-style-type: none"> • Console: Upgrade the program and debug with the console and mini terminal software. • Keyboard: Control this Device with special keyboard. • Adapter: Connect with PC directly for transparent transmission of data. • Protocol COM: Configure the function to protocol COM, in order to overlay card number. • PTZ Matrix: Connect matrix control  <p>Different series products support different RS232 functions. The actual product shall prevail.</p>
Baud Rate	Select Baud rate, which is 115200 by default.
Data Bits	It ranges from 5 to 8, which is 8 by default.
Stop Bits	It includes 1 and 2.
Parity	It includes none, odd, even, mark and null.

Step 4 Click **Apply**.

4.14 Security

You can set security options to strengthen device security and use the device in a much safer way.

4.14.1 Security Status

Security scanning helps get a whole picture of device security status. You can scan user, service and security module status for detailed information about the security status of the device.

Detecting User and Service



Green icon represents a healthy status of the scanned item, and orange icon represents a risky status.

- Login authentication: When there's a risk in the device configuration, the icon will be in orange to warn risk. You can click **Details** to see the detailed risk description.
- User Status: When one of device users or Onvif users uses weak password, the icon will be in orange to warn risk. You can click **Details** to optimize or ignore the risk warning.

Figure 4-267

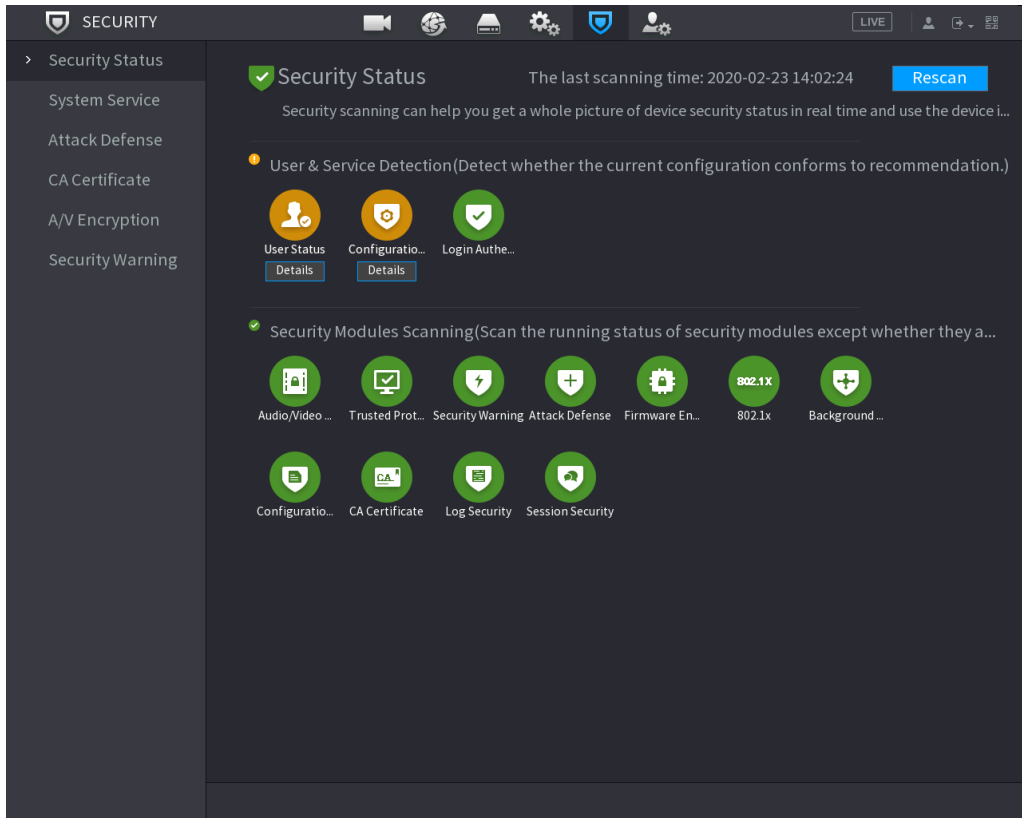
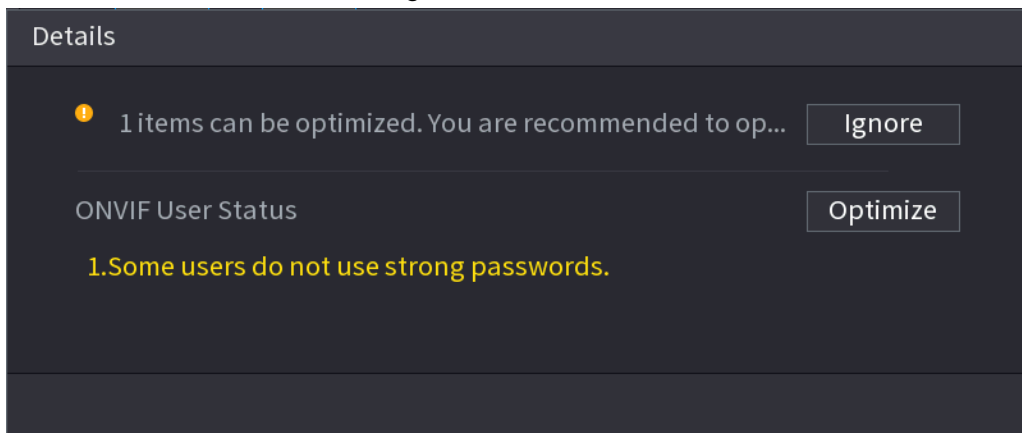
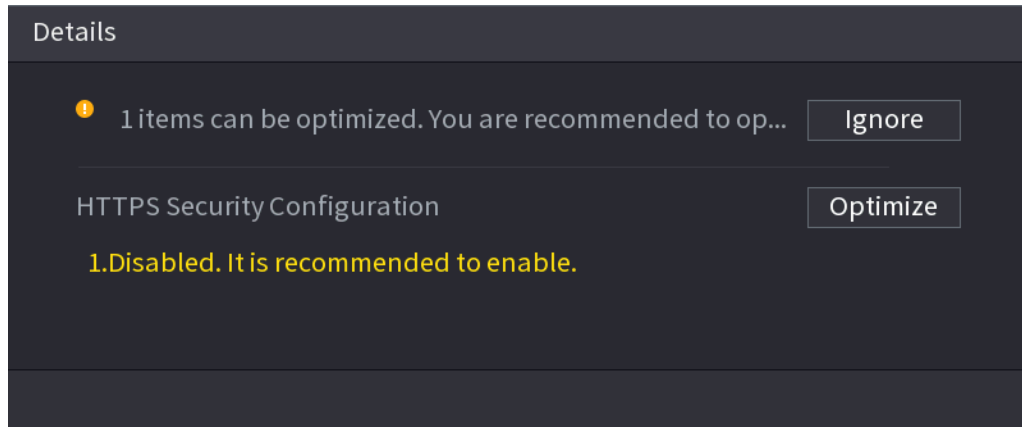

Figure 4-268



- Configuration Security: When there's a risk in the device configuration, the icon will be in orange to warn risk. You can click **Details** to see the detailed risk description. See Figure 4-269.

Figure 4-269



Scanning Security Modules

This area shows the running status of security modules. For details about the security modules, move mouse pointer on the icon to see the on-screen instructions.

Scanning Security Status

You can click **Rescan** to scan security status.

4.14.2 System Service

You can set NVR basic information such as basic services, 802.1x and HTTPS.

4.14.2.1 Basic Services

Procedure

- Step 1 Select **Main Menu > SECURITY > System Service > Basic Services**.
The **Basic Services** interface is displayed. See Figure 4-270.

Figure 4-270

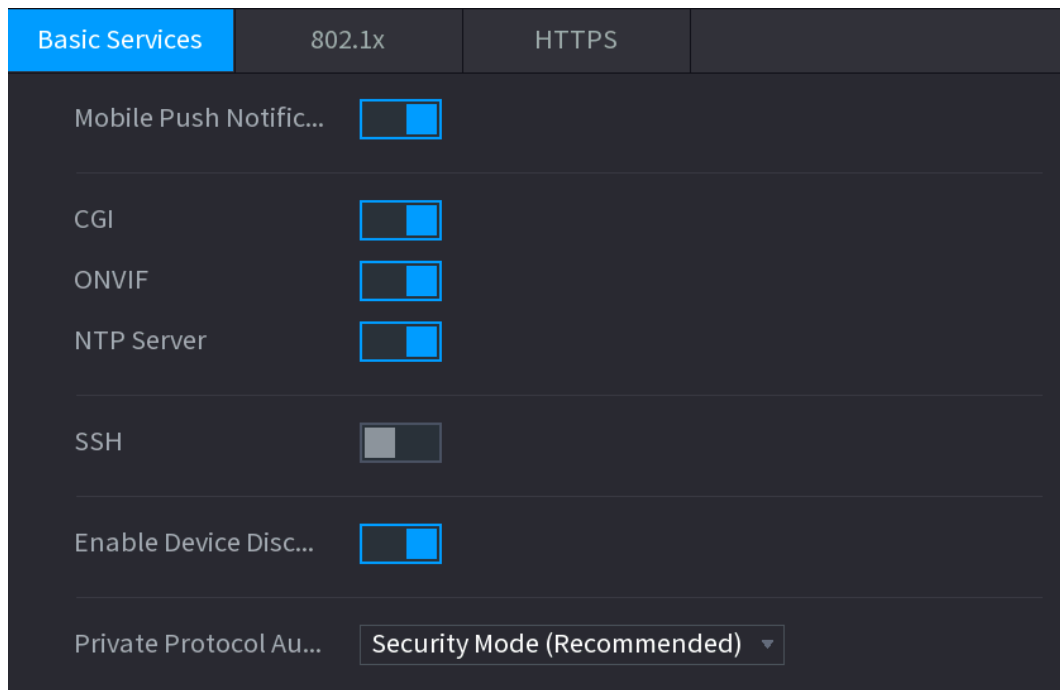

Step 2 Select **Basic Services** and configure parameters.

There might be safety risk when **Mobile Push Notifications**, **CGI**, **ONVIF**, **SSH** and **NTP Server** is enabled.

Table 4-85 Basic service parameters

Parameter	Description
Mobile Push Notifications	After enabling this function, the alarm triggered by the NVR can be pushed to a mobile phone. This function is enabled by default.
CGI	If this function is enabled, the remote devices can be added through the CGI protocol. This function is enabled by default.
ONVIF	If this function is enabled, the remote devices can be added through the ONVIF protocol. This function is enabled by default.
NTP Server	After enabling this function, a NTP server can be used to synchronize the device. This function is enabled by default.
SSH	After enabling this function, you can use SSH service. This function is disabled by default.
Enable Device Discovery	After enabling this function, the NVR can be found by other devices through searching.
Private Protocol Authentication Mode	<ul style="list-style-type: none"> Security Mode (Recommended): Uses Digest access authentication when connecting to NVR. Compatible Mode: Select this mode when the client does not support Digest access authentication.

Step 3 Click **Apply** to complete the settings.

4.14.2.2 802.1x

The device needs to pass 802.1x certification to enter the LAN.

Procedure

- Step 1** Select **Main Menu > SECURITY > System Service > 802.1x**.
The **802.1x** interface is displayed. See Figure 4-271

Figure 4-271

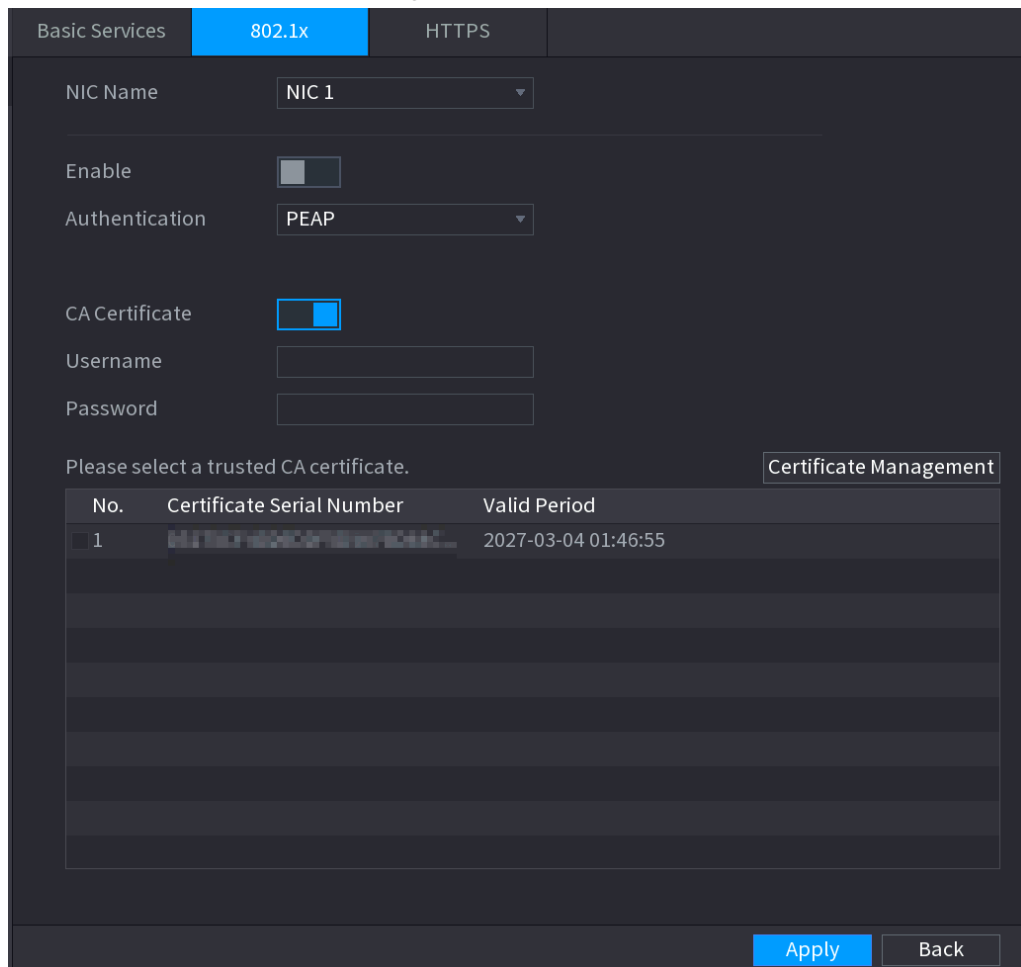

- Step 2** Select the Ethernet card you want to certify.
Step 3 Select **Enable** and configure parameters. See Table 4-86.

Table 4-86 802.1x parameters

Parameter	Description
Authentication	<ul style="list-style-type: none"> PEAP: protected EAP protocol. TLS: Transport Layer Security. Provide privacy and data integrity between two communications application programs.
CA Certificate	Enable it and click Browse to import CA certificate from flash drive. For details about importing and creating a certificate, see "4.14.4 CA Certificate".
Username	The username shall be authorized at server.
Password	Password of the corresponding username.

- Step 4** Click **Apply** to complete the settings.

4.14.2.3 HTTPS

Background Information

We recommend that you enable HTTPS function to enhance system security.

Procedure

- Step 1 Select **Main Menu > SECURITY > System Service > HTTPS**.
The **HTTPS** interface is displayed. See Figure 4-272.

Figure 4-272

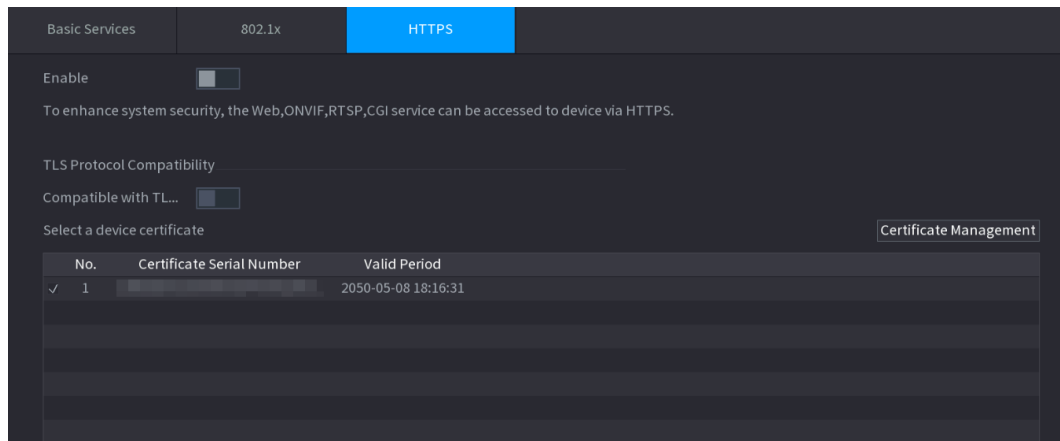

- Step 2 Enable HTTPS function.
- Step 3 (Optional) Enable **Compatible with TLSv1.1 and earlier versions** to allow protocol compatibility.
- Step 4 Click **Certificate Management** to create or import a HTTPS certificate from USB drive. For details about importing or creating a CA certificate, see "4.14.4 CA Certificate".
- Step 5 Select a HTTPS certificate.
- Step 6 Click **Apply** to complete the settings.

4.14.3 Attack Defense

4.14.3.1 Firewall

Procedure

- Step 1 Select **Main Menu > SECURITY > Attack Defense > Firewall**.
The **HTTPS** interface is displayed. See Figure 4-273.

Figure 4-273 Firewall

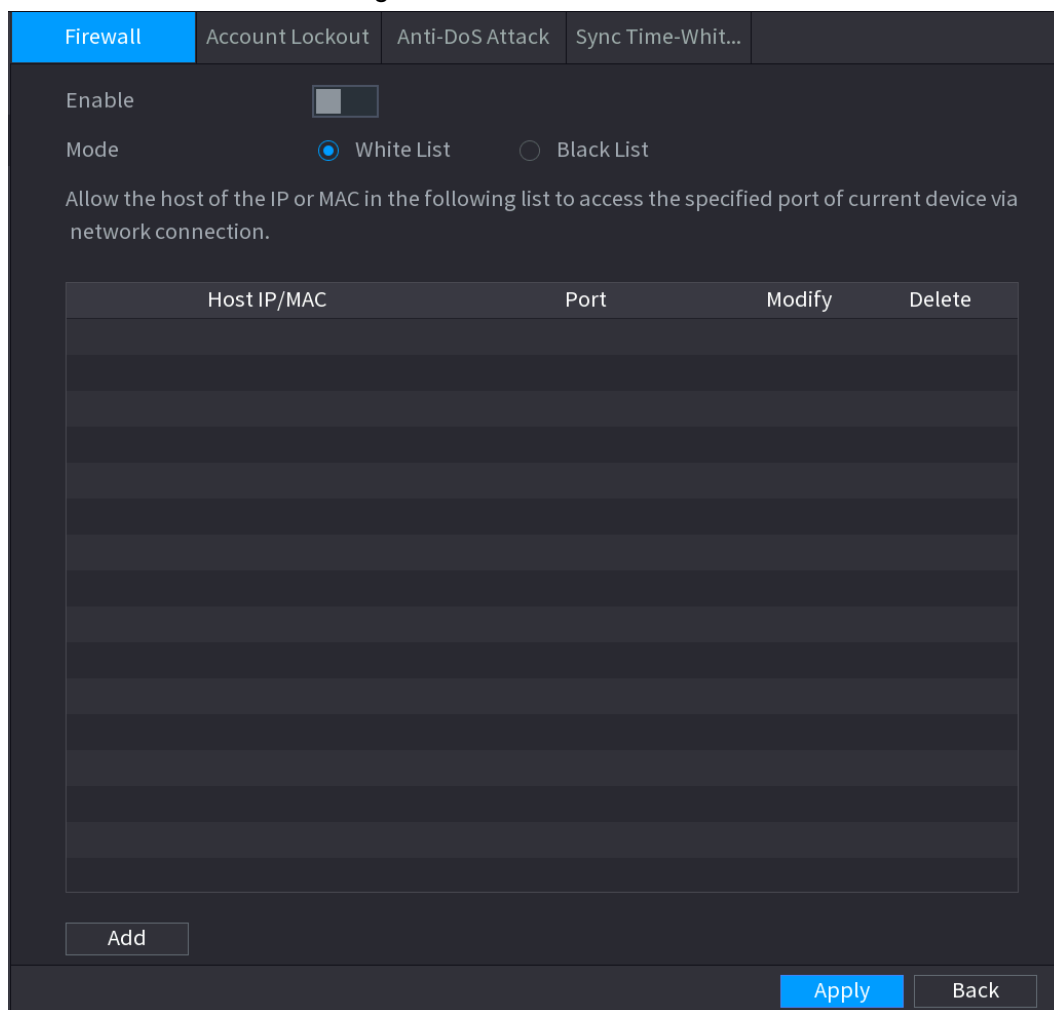



Step 2 Select **Enable** to enable firewall.

Step 3 Configure the parameters. See Table 4-87.

Table 4-87 Parameters

Parameter	Description
Mode	Mode can be configured when Type is Network Access. <ul style="list-style-type: none"> • If Trusted Sites is enabled, you can visit device port successfully with IP/MAC hosts in Trusted Sites. • If Blocked Sites is enabled, you cannot visit device port with IP/MAC hosts in Blocked Sites.
Add	When Type is Network Access, you can configure IP Address, IP Segment and MAC Address.
Type	You can select IP address, IP segment and MAC address.
IP Address	Enter IP Address, Start Port and End Port that is allowed or forbidden.
Start Port	
End Port	When Type is IP Address, they can be configured. Start Port and End Port can be configured only in Network Access Type.

Parameter	Description
Start Address	Enter Start Address and End Address of IP Segment.  When Type is IP Segment, they can be configured.
MAC Address	Enter MAC Address that is allowed or forbidden  When Type is MAC Address, they can be configured.

Step 4 Click **Apply** to complete the settings.

4.14.3.2 Account Lockout

Procedure

Step 1 Select **Main Menu > SECURITY > Attack Defense > Account Lockout**.
The **Account Lockout** interface is displayed. See Figure 4-274.

Figure 4-274 Account lockout

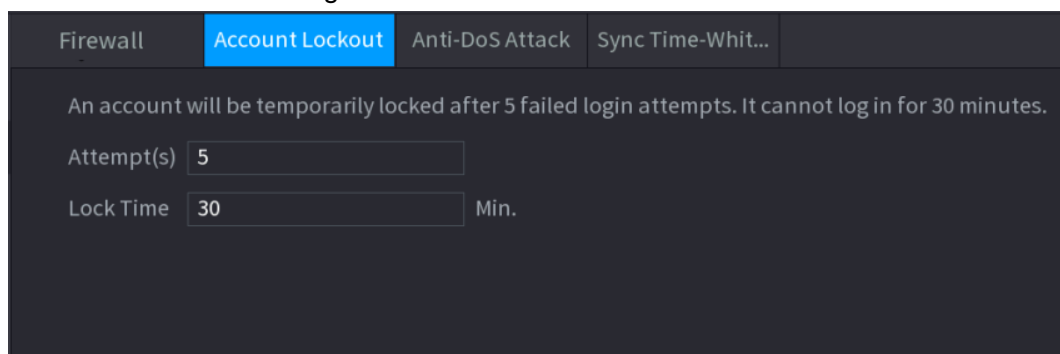

Step 2 Set parameters. See Table 4-88.

Table 4-88 Account lockout parameters

Parameter	Description
Attempt(s)	Set the maximum number of allowable wrong password entries. The account will be locked after your entries exceed the maximum number. Value range: 5–30. Default value: 5.
Lock Time	Set how long the account is locked for. Value range: 5–120 minutes. Default value: 30 minutes.

Step 3 Click **Apply** to complete the settings.

4.14.3.3 Anti-Dos Attack

You can enable **SYN Flood Attack Defense** and **ICMP Flood Attack Defense** to defend the device against Dos attack. See Figure 4-275.

Figure 4-275 Anti-Dos Attack

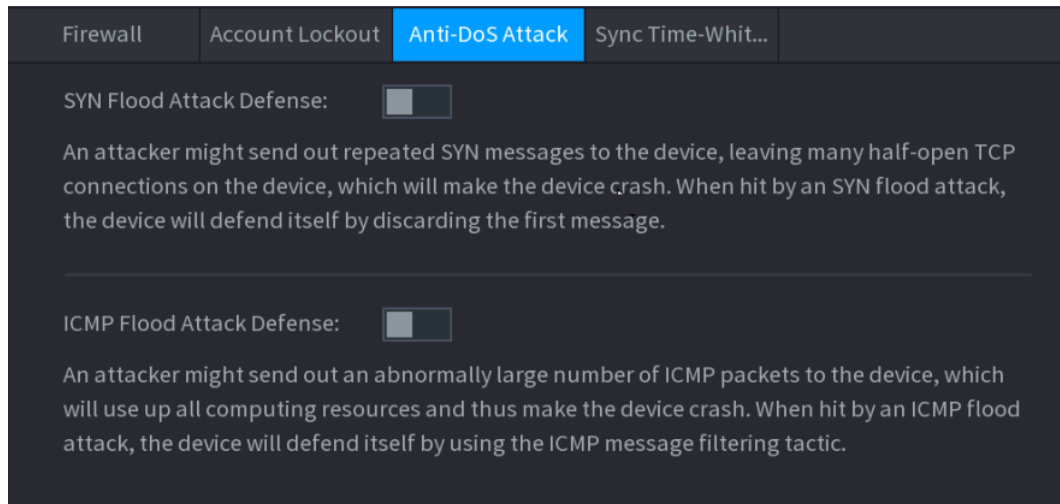

4.14.3.4 Sync Time-Allowlist



The synchronization is only allowed with hosts in the trusted list.

Procedure

- Step 1 Select **Main Menu > SECURITY > Attack Defense > Sync Time-Allowlist**.
The **Sync Time-Allowlist** interface is displayed. See Figure 4-276.

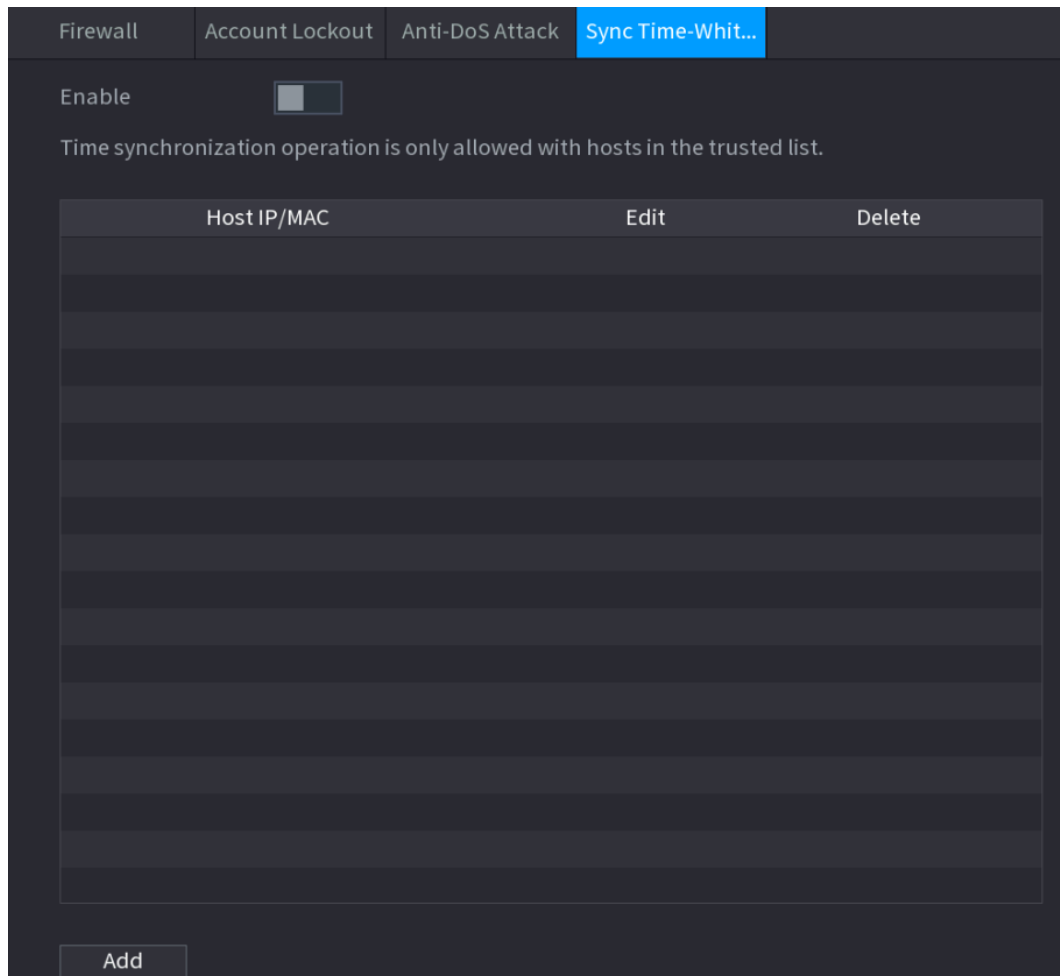

Figure 4-276 Sync Time-Allowlist



Step 2 Select **Enable** to enable **Sync Time-Allowlist** function.

Step 3 Configure the parameters. See Table 4-89.

Table 4-89 Sync Time-Allowlist parameters

Parameter	Description
Add	You can add trusted hosts for time synchronization.
Type	Select IP address or IP segment for hosts to be added.
IP Address	Input the IP address of a trusted host.  When Type is IP Address, it can be configured
Start Address	Input the start IP address of trusted hosts.  When Type is IP Segment, it can be configured
End Address	Input the end IP address of trusted hosts.  When Type is IP Segment, it can be configured

Step 4 Click **Apply** to complete the settings.

4.14.4 CA Certificate

4.14.4.1 Device Certificate

Create Certificate

1. Select **Main Menu > SECURITY > CA Certificate > Device Certificate**.
The **Device Certificate** interface is displayed. See Figure 4-277.

Figure 4-277 Device Certificate

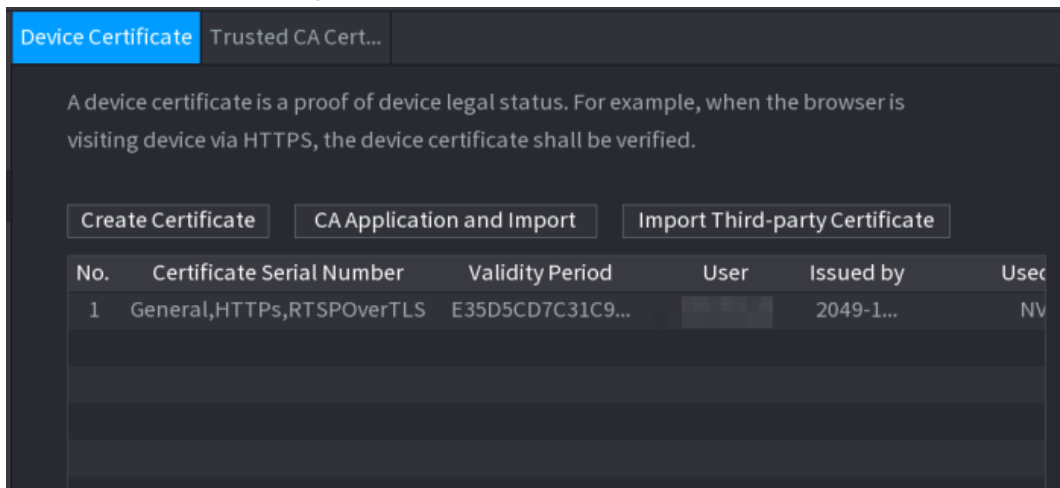

2. Configure parameters. See Table 4-90.

Table 4-90 Creating certificate

Parameter	Description
County	This parameter is user defined.
State	This parameter is user defined.
City Name	This parameter is user defined.
Valid Period	Input a valid period for the certificate.
Organization	This parameter is user defined.
Organization Unit	This parameter is user defined.
Domain Name	Input the domain name or IP address of the certificate.

3. Click **Create**.

CA Application and Import

Follow the on-screen instructions to finish CA application and import. See Figure 4-278.

Figure 4-278 CA application and import

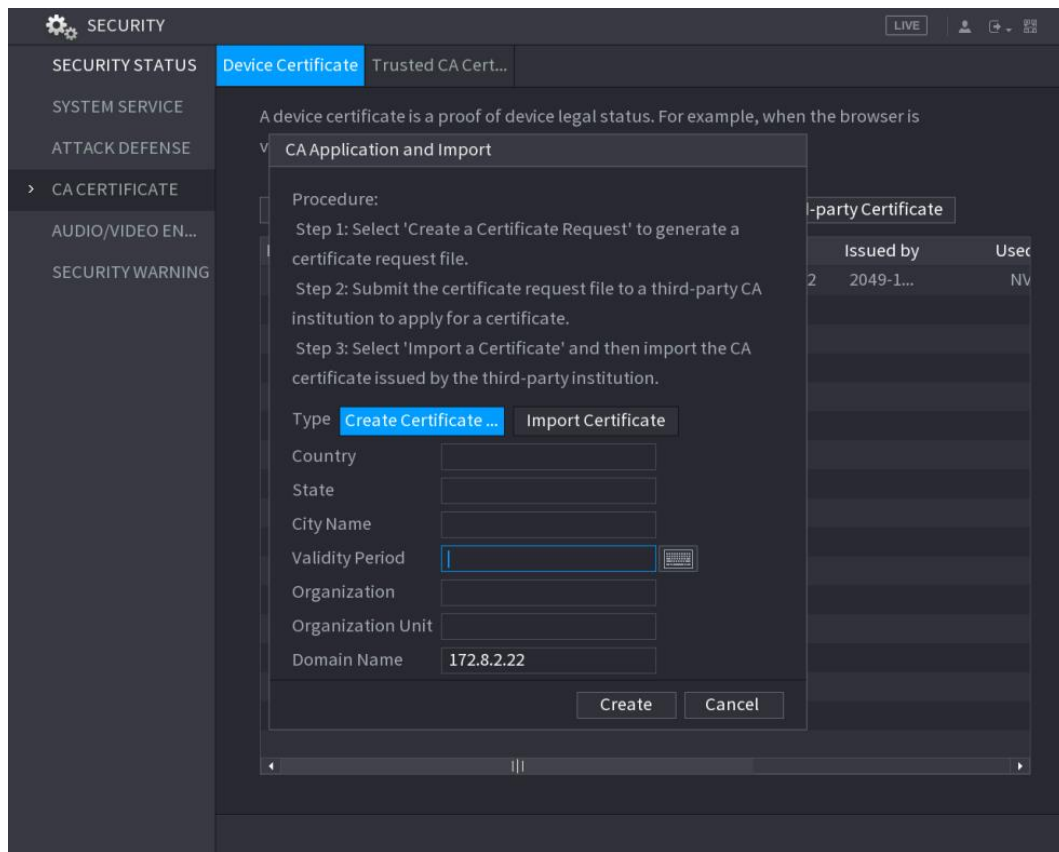

Import Third-Party Certificate

1. Configure Parameters. See Table 4-91.

Table 4-91 Importing third-party certificate

Parameter	Description
Path	Click Browse to find the third-party certificate path on the USB drive.
Private Key	Click Browse to find the third-party certificate private key on the USB drive.
Private Key Password	Input the private key password.

2. Click **Create**.

4.14.4.2 Trusted CA Certificate

Procedure

- Step 1 Select **Main Menu > SECURITY > CA Certificate > Trusted CA Certificate**.
- Step 2 Click **Install Trusted Certificate**.
The **Create Certificate** is displayed. See Figure 4-279.

Figure 4-279 Creating certificate

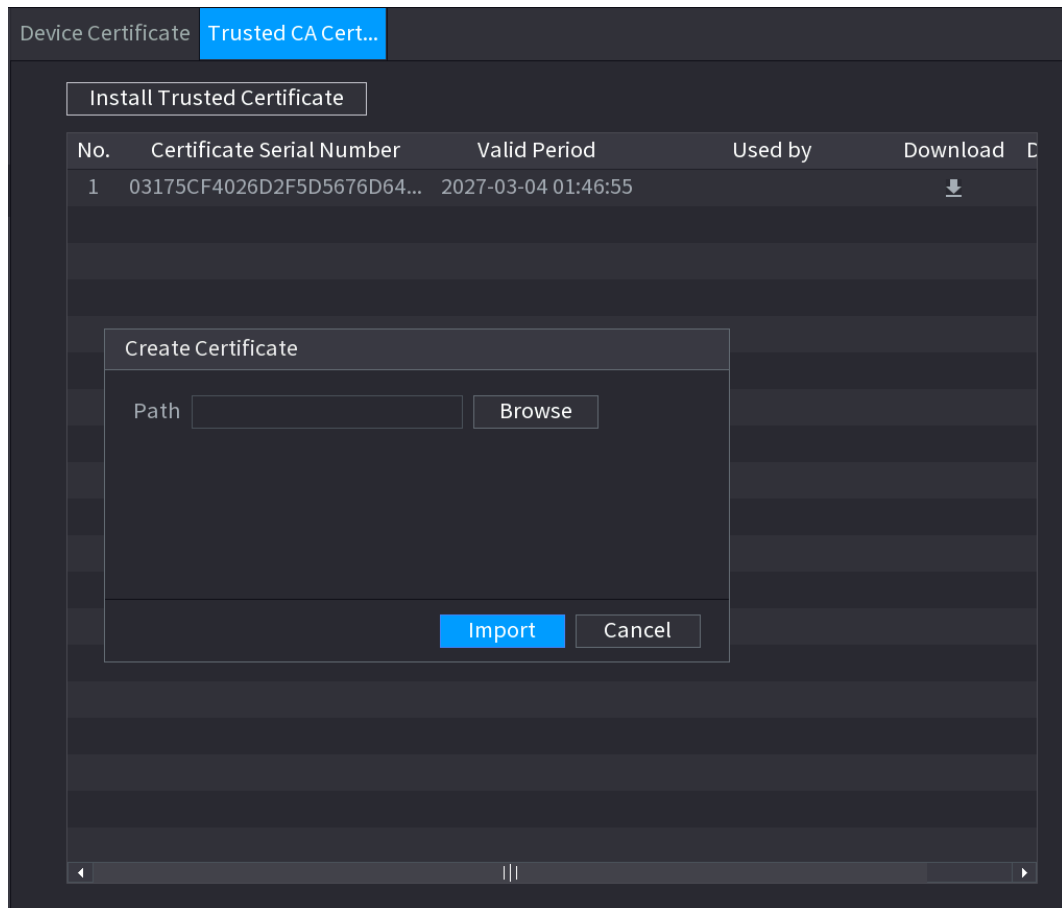

Step 3 Click **Browse** to select the certificate that you want to install.

Step 4 Click **Import**.

4.14.5 Audio/Video Encryption

Background Information

The device supports audio and video encryption during data transmission.

Procedure

Step 1 Select **Main Menu > SECURITY > AUDIO/VIDEO ENCRYPTION > Audio/Video Transmission**.

The **Audio/Video Transmission** interface is displayed. See Figure 4-280.

Figure 4-280 Audio and video transmission

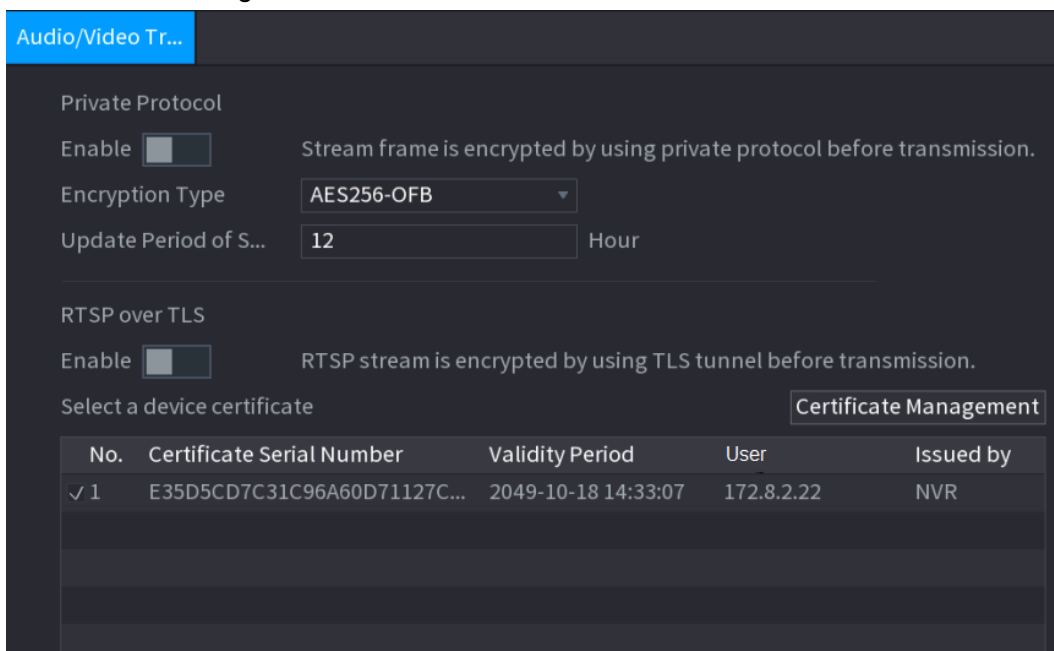

Step 2 Configure parameters. See Table 4-92.

Table 4-92 Audio and video transmission parameters

Area	Parameter	Description
Private Protocol	Enable	Enables stream frame encryption by using private protocol. There might be safety risk if this service is disabled.
	Encryption Type	Use the default setting.
	Update Period of Secret Key	Secret key update period. Value range: 0–720 hours. 0 means never update the secret key. Default value: 12.
RTSP over TLS	Enable	Enables RTSP stream encryption by using TLS. There might be safety risk if this service is disabled.
	Select a device certificate	Select a device certificate for RTSP over TLS.
	Certificate Management	For details about certificate management, see "4.14.4.1 Device Certificate".

Step 3 Click **Apply** to complete the settings.

4.14.6 Security Warning

4.14.6.1 Security Exception

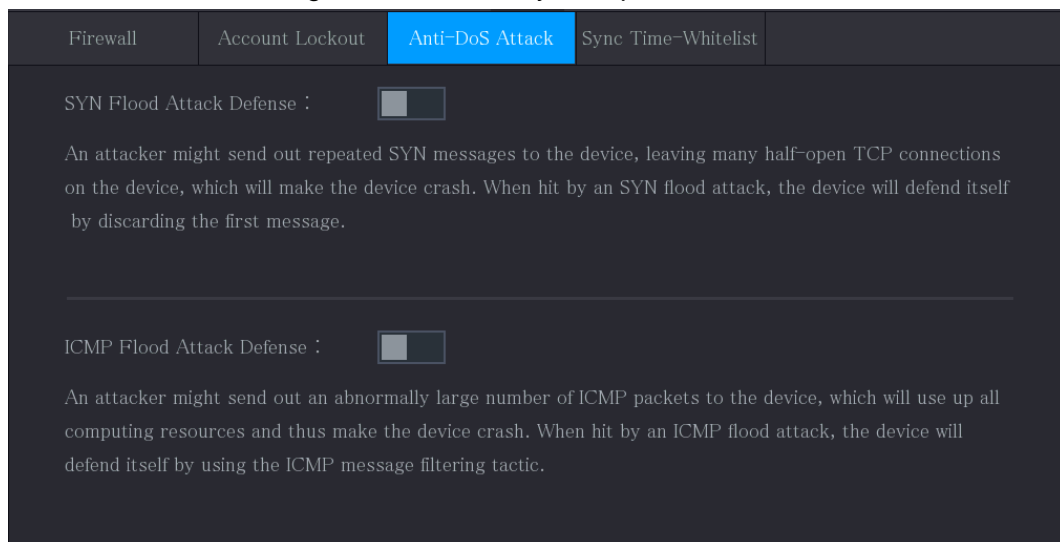

Step 1 Select **Main Menu > SECURITY > Security Warning > Security Exception**. The **Security Exception** interface is displayed. See Figure 4-281.

Figure 4-281 Security Exception



Step 2 Select **Enable** and configure parameters. See Table 4-93.

Table 4-93 Security exception parameters

Parameter	Description
Alarm-out Port	The alarm device (such as lights, sirens, etc.) is connected to the alarm output port. When an alarm occurs, the NVR device transmits the alarm information to the alarm device.
Post-Alarm	When the alarm ends, the alarm extended for a period of time. The time range is from 0 seconds to 300 seconds.
Show Message	Check box to enable a pop-up message in your local host PC.
Buzzer	Select the check box to activate the buzzer when an alarm occurs.
Alarm Tone	Check the box and then select the corresponding audio file from the dropdown list. System plays the audio file when the alarm occurs.  See "4.17.1 File Management" to add audio file first.
Log	Select the check box, the NVR device records the alarm information in the log when an alarm occurs.
Send Email	Select the check box. When an alarm occurs, the NVR device sends an email to the set mailbox to notify the user.  You need to set the email first. For details, see "4.11.11 Email".

Parameter	Description
②	<p>Security Event monitoring explanation. It indicates the type of attacks that can trigger security exception.</p> <ul style="list-style-type: none"> • Unauthorized executable program trying to run • Web URL brute-force attack • Session connection overload • Session ID brute-force attack

Step 3 Click **Apply** to complete the settings.

4.14.6.2 Illegal Login

Step 1 Select **Main Menu > SECURITY > Security Warning > Illegal Login**.
The **Illegal Login** interface is displayed. See Figure 4-282.

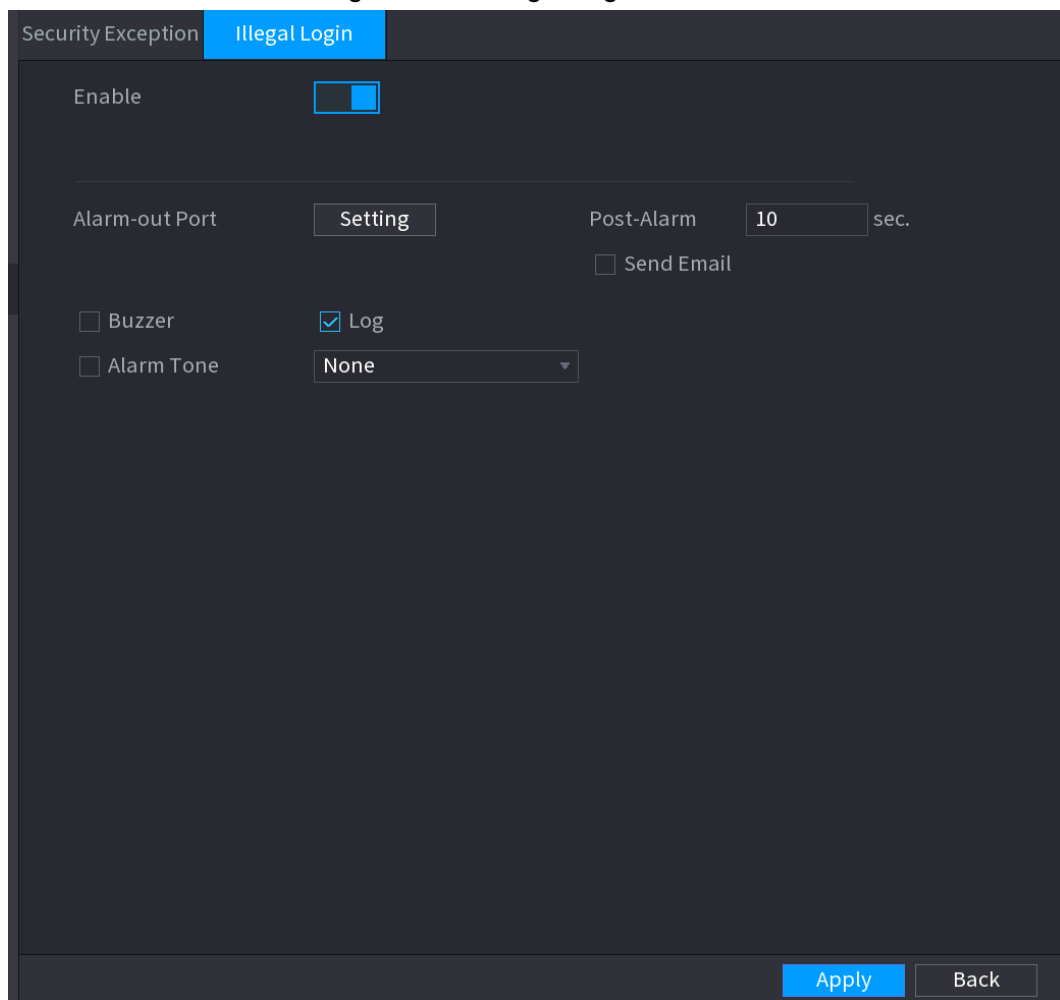

Figure 4-282 Illegal Login



Step 2 Select **Enable** and configure parameters. See Table 4-94.

Table 4-94 Illegal login parameters

Parameter	Description
Alarm-out Port	The alarm device (such as lights, sirens, etc.) is connected to the alarm output port. When an alarm occurs, the NVR device transmits the alarm information to the alarm device.

Parameter	Description
Post Alarm	When the alarm ends, the alarm extended for a period of time. The time range is from 0 seconds to 300 seconds.
Buzzer	Select the check box to activate the buzzer when an alarm occurs.
Alarm Tone	Check the box and then select the corresponding audio file from the dropdown list. System plays the audio file when the alarm occurs.  See "4.17.1 File Management" to add audio file first.
Log	Select the check box, the NVR device records the alarm information in the log when an alarm occurs.
Send Email	Select the check box. When an alarm occurs, the NVR device sends an email to the set mailbox to notify the user.  You need to set the email first. For details, see "4.11.11 Email".

4.15 Account

You can manage users, user group and ONVIF user, set admin security questions.



- For the user name, the string max length is 31-byte, and for the user group, the string max length is 15-byte. The user name can only contain English letters, numbers and “_”, “@”, “.”
- The default user amount is 64 and the default group amount is 20. System account adopts two-level management: group and user. The user authorities shall be smaller than group authorities (The admin user authorities are set by default).
- For group or user management, there are two levels: admin and user. The user name shall be unique and one user shall only belong to one group.

4.15.1 User

4.15.1.1 Add User

Procedure

- Step 1 Select **Main Menu > ACCOUNT > User**.
 The **User** interface is displayed. See Figure 4-283.

Figure 4-283

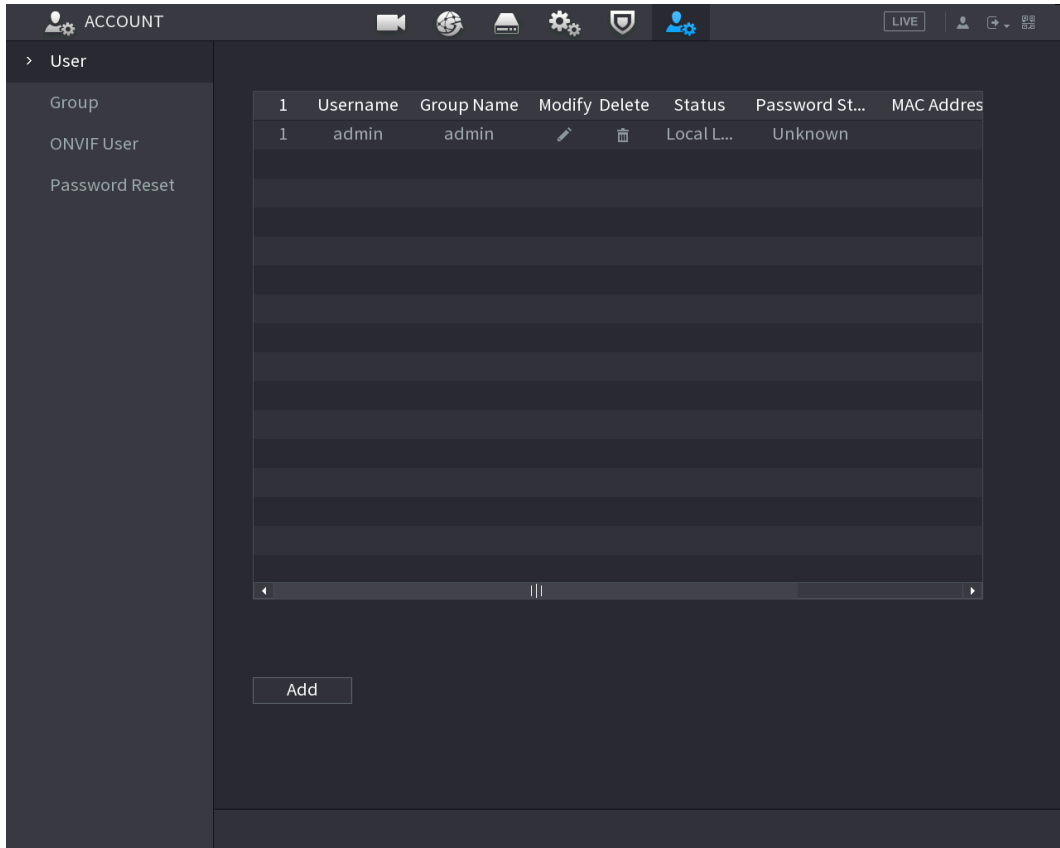

Step 2 Click **Add**.

The **Add** interface is displayed. See Figure 4-284.

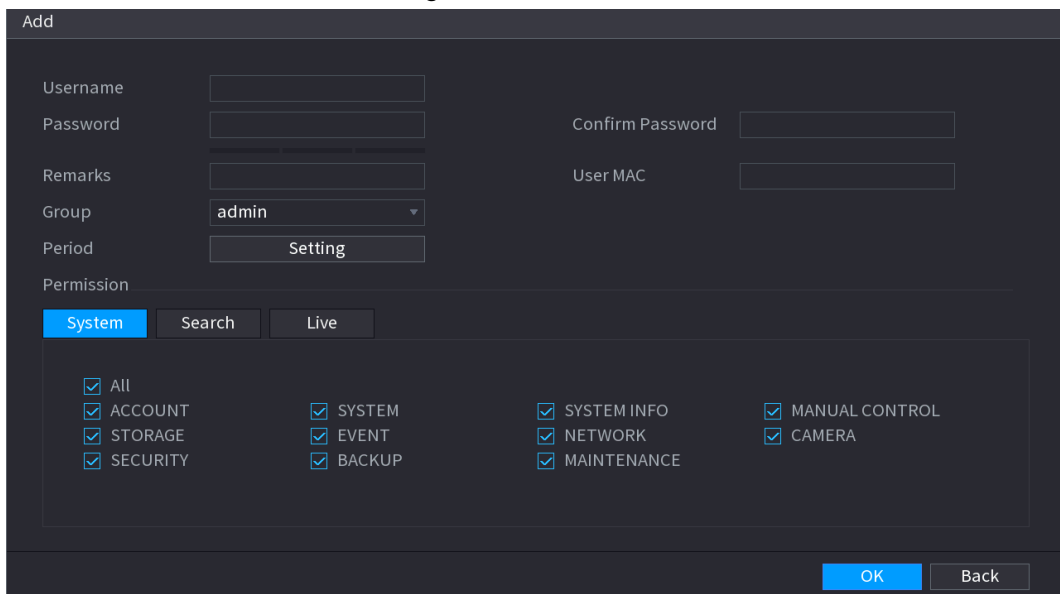

Figure 4-284



Step 3 Input the user name, password, select the group it belongs to from the drop-down list. Then you can check the corresponding rights for current user. See Table 4-95.

Table 4-95

Parameter	Description
Username	Enter a user name and password for the account.

Parameter	Description
Password	
Confirm Password	Re-enter the password.
Remarks	Optional. Enter a description of the account.
User MAC	Enter user MAC address
Group	Select a group for the account.  The user rights must be within the group permission.
Period	Click Setting to display Setting interface. Define a period during which the new account can login the device. The new account cannot login the device during the time beyond the set period.
Permission	In the Permission area, select the check boxes in the System tab, Search tab, and Live tab.  To manage the user account easily, when defining the user account authority, it is recommended not to give the authority to the common user account higher than the advanced user account.

Step 4 Click **OK** button.



Click  to modify the corresponding user information, click  to delete the user.

4.15.1.2 Modify Password

Procedure

Step 1 Select **Main Menu > ACCOUNT > User**, click  of the corresponding user.
The **Modify User** interface is displayed. See Figure 4-285.

Figure 4-285

Step 2 Check the box to enable **Modify Password** function. Enter old password and then enter new password twice.



- Password/confirm password: The password ranges from 8 to 32 digitals. It can contain letters, numbers and special characters (excluding “'” , “|” , “,” , “.” , “&”). The password shall contain at least two categories. Usually we recommend the strong password.
- For the user of account authority, it can modify the password of other user.
- STRONG PASSWORD RECOMMENDED-For your device own safety, create a strong password of your own choosing. We also recommend you change your password periodically especially in the high security system.
- Check the box to enable Unlock Pattern function, click

Step 3 Enter the **Unlock Pattern** interface to set. See Figure 4-286.

Figure 4-286

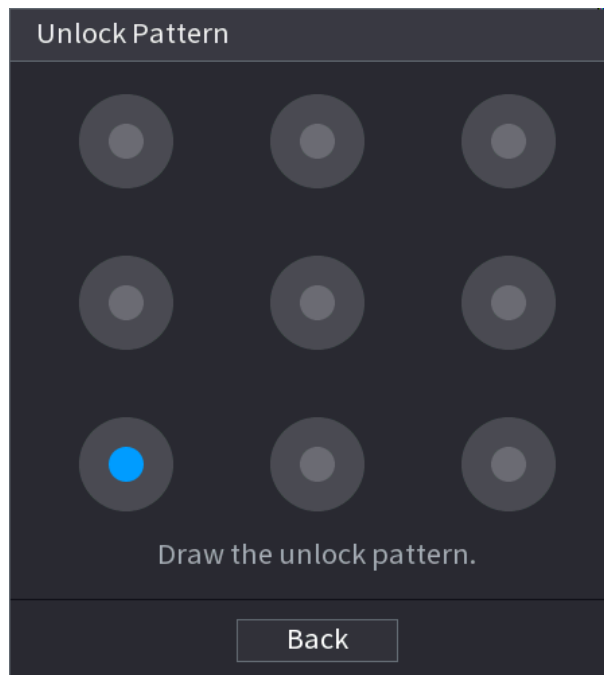

Step 4 Click **Back**.

4.15.2 Group

Procedure

Step 1 Select **Main Menu > ACCOUNT > Group**.
The **Group** interface is displayed. See Figure 4-287.



Click to modify the corresponding group information, click to delete the group.

4.15.3 Reset Password

Background Information

You can set security questions and answers. After you successfully answered security questions, you can reset admin account password.



This function is for **admin** user only.

Procedure

- Step 1** Select **Main Menu > ACCOUNT > Password Reset**.
The **Password Reset** interface is displayed. See Figure 4-289.

Figure 4-289

- Step 2** Check the box to enable Reset password function.



This function is enabled by default.

- Step 3** Input proper security questions and answers.

- Step 4** Click **OK**.

After you successfully set security questions, you can answer the security questions to reset **admin** password.

4.15.4 ONVIF User

Background Information

When the camera from the third party is connected with the NVR via the ONVIF user, use the verified ONVIF account to connect to the NVR. Here you can add/delete/modify user.





- The default ONVIF user is **admin**. It is created after you initialize the NVR.
- For some series product, the ONVIF user password is modified when you are initializing the admin password.

Procedure

- Step 1 Select **Main Menu > ACCOUNT > ONVIF User**.
The **ONVIF User** interface is displayed. See Figure 4-290

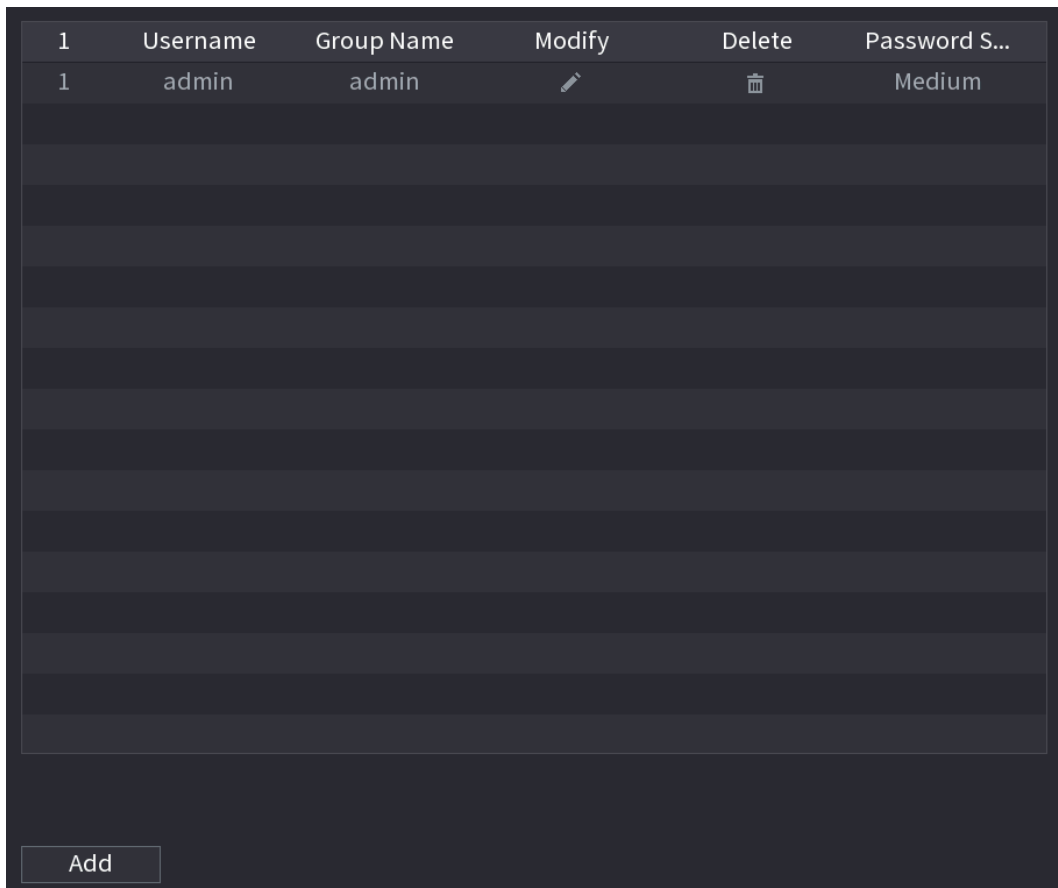
Figure 4-290



1	Username	Group Name	Modify	Delete	Password S...
1	admin	admin			Medium

Add

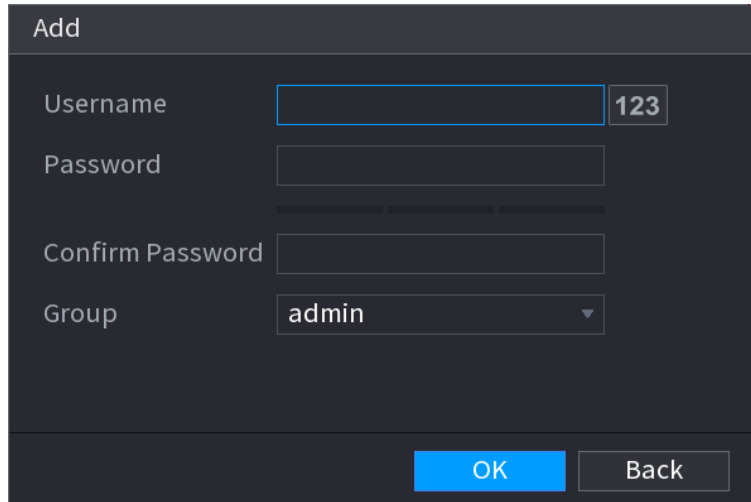

- Step 2 Click **Add**.
The **Add** interface is displayed. See Figure 4-291.

Figure 4-291



Step 3 Set user name, password and then select group from the drop-down list.

Step 4 Click **OK** to complete setup.

Click  to modify the corresponding user information, click  to delete current user.

4.16 Output and Display

4.16.1 Display

Background Information

You can configure the display effect such as displaying time title and channel title, adjusting image transparency, and selecting the resolution.

Procedure

Step 1 Select **Main Menu > DISPLAY > Display**.

The **Display** interface is displayed. See Figure 4-292.

Figure 4-292

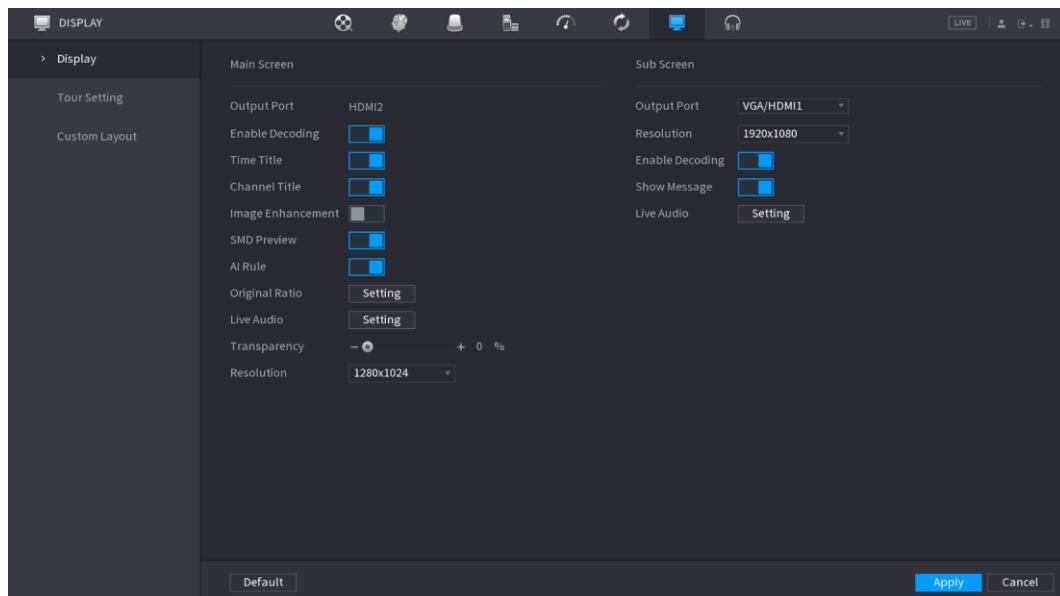

Step 2 Configure the settings for the display parameters.

Table 4-96

Parameter	Description
Main Screen/Sub Screen	Configure the output port format of both screens. <ul style="list-style-type: none"> When sub screen is disabled, the format of main screen is HDMI/VGA simultaneous output. When sub screen is enabled, the format of main screen and sub screen are non-simultaneous outputs. <ul style="list-style-type: none"> When output port of sub screen is set to HDMI, the output port of main screen is set to VGA by the device. When output port of sub screen is set to VGA, the output port of main screen is set to HDMI by the device.
Enable Decoding	After it is enabled, the device can normally decode.
Time Title/Channel Title	Select the check box and the date and time of the system will be displayed in the preview screen.
Transparency	Set the transparency of the local menu of the NVR device. The higher the transparency, the more transparent the local menu.
Time Title/Channel Title	Select the check box and the date and time of the system will be displayed in the preview screen.
Image Enhancement	Select the check box to optimize the preview image edges.
SMD Preview	Select the check box to display the SMD previews in the live view interface.
AI Rule	Select the check box to display the AI rules in the live view interface.  This function is for some series products only.
Original Ratio	Click Setting and select the channel to restore the corresponding channel image to the original scale.

Parameter	Description
Live Audio	Configure audio input on live view. You can select Audio 1 , Audio 2 , and Mixing . For example, if you select Audio 1 for D1 channel, the sound of audio input port 1 of camera is playing. If you select Mixing , the sound of all audio input ports are playing.
Resolution	Support 1920×1080, 1280×1024(default), 1280×720.

Step 3 Click **Apply**.

4.16.2 Tour

Background Information

You can configure a tour of selected channels to repeat playing videos. The videos display in turn according to the channel group configured in tour settings. The system displays one channel group for a certain period and then automatically changes to the next channel group.

Procedure

Step 1 Select **DISPLAY > Tour Setting > Main Screen**.
The **Tour** interface is displayed. See Figure 4-293.

Figure 4-293

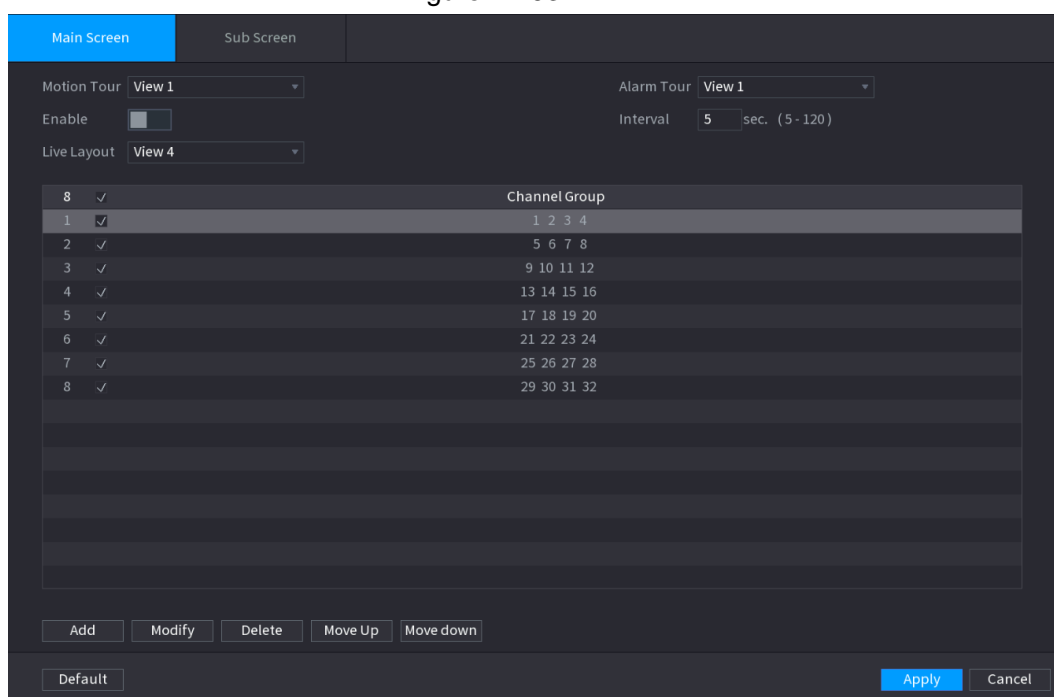

- On the top right of the live view screen, use the left mouse button or press Shift to switch between (image switching is allowed) and (image switching is not allowed) to turn on/off the tour function.
- On the navigation bar, click to enable the tour and click to disable it.

Step 2 Configure the tour setting parameters. See Table 4-97.

Table 4-97

Parameter	Description
Enable Tour	Enable tour function.
Interval	Enter the amount of time that you want each channel group displays on the screen. The value ranges from 5 seconds to 120 seconds, and the default value is 5 seconds.
Motion Tour, Alarm Tour	Select the View 1 or View 8 for Motion Tour and Alarm Tour (system alarm events).
Live Layout	In the Live Layout list, select View 1 , View 4 , View 8 , or other modes that are supported by the Device.
Channel Group	Display all channel groups under the current Window Split setting. <ul style="list-style-type: none"> • Add a channel group: Click Add, in the pop-up Add Group channel, select the channels to form a group, and then click Save. • Delete a channel group: Select the check box of any channel group, and then click Delete. • Edit a channel group: Select the check box of any channel group and then click Modify, or double-click on the group. The Modify Channel Group dialog box is displayed. You can regroup the channels. • Click Move up or Move down to adjust the position of channel group.

Step 3 Click **Apply** to save the settings.

4.16.3 Custom Layout

Background Information

You can set customized video split mode.



- This function is for some series products. Refer to the actual product for detailed information.
- Device max. supports 5 customized videos.

Procedure

- Step 1 Select **Main Menu > DISPLAY > Custom Split**.
The **Custom Split** interface is displayed. See Figure 4-294.

Figure 4-294

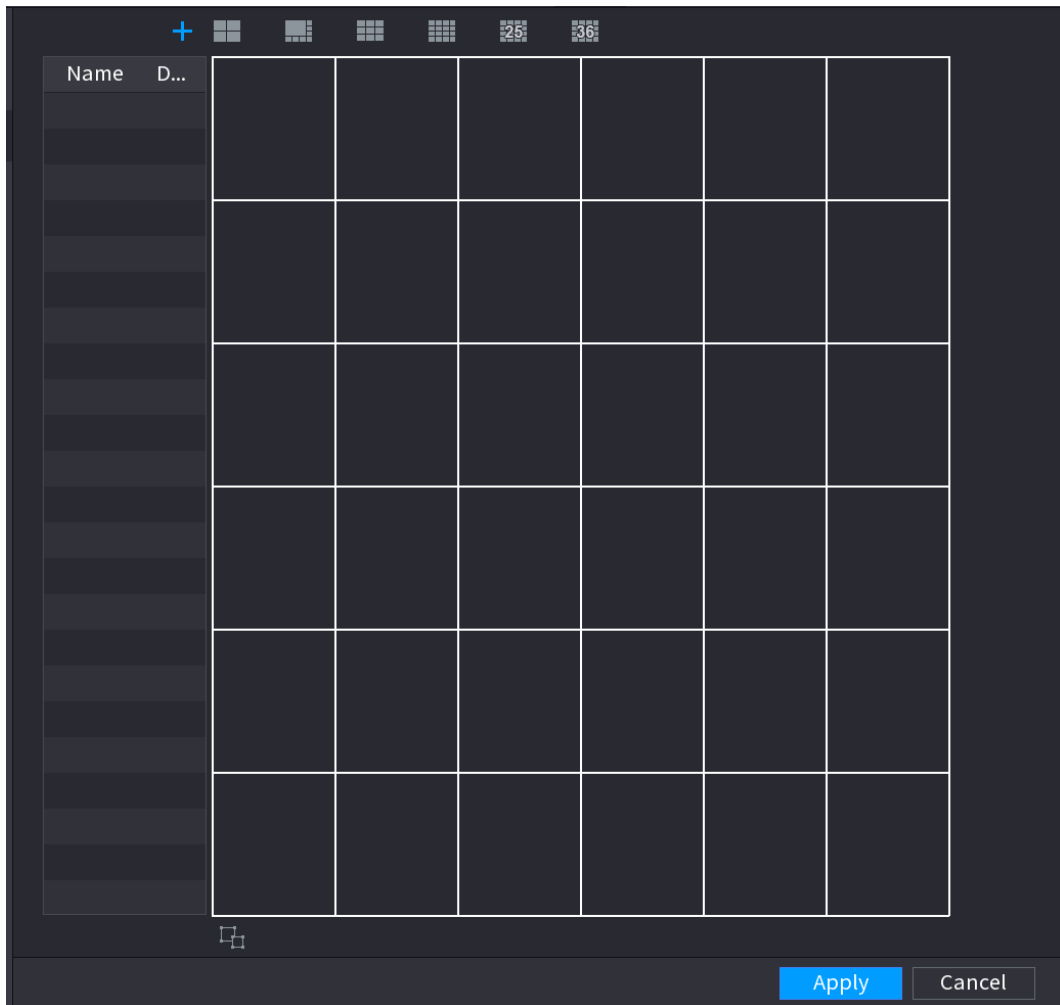

- Step 2** Click **+** and then click **[2x2 grid]** to select basic mode. System adopts the basic window mode as the new window name. For example, if you select the 8 display mode, the default name is Split8. In regular mode, drag the mouse in the preview frame; you can merge several small windows to one window so that you can get your desired split mode. See Figure 4-295.



- After merge the window, system adopts the remaining window amount as the new name such as Split6.
- Select the window you want to merge (red highlighted), click to cancel the merge to restore the basic mode.
- Click to delete the customized window mode.

Figure 4-295

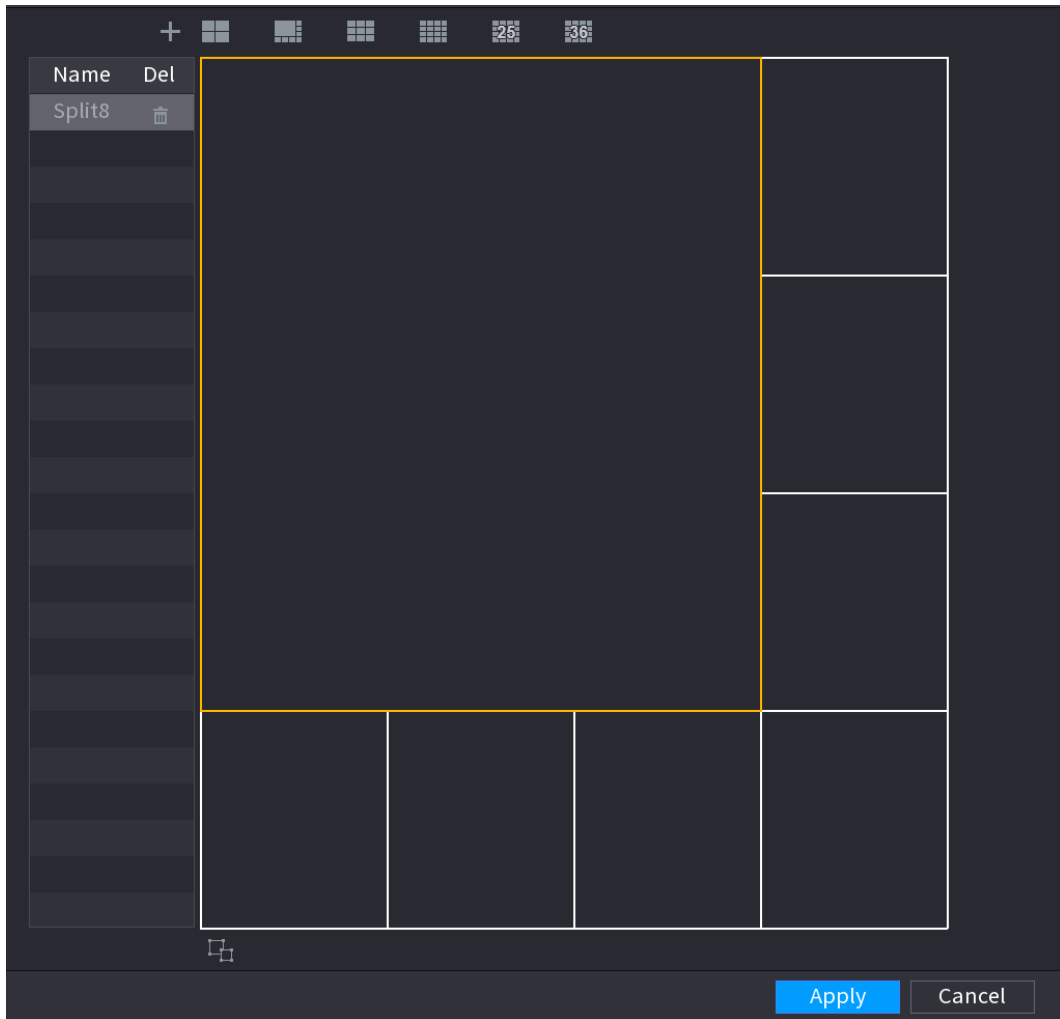

Step 3 Click **Apply** to exit.

After the setup, you can go to the preview window, right click mouse and then select Custom Split. See Figure 4-296.

Figure 4-296

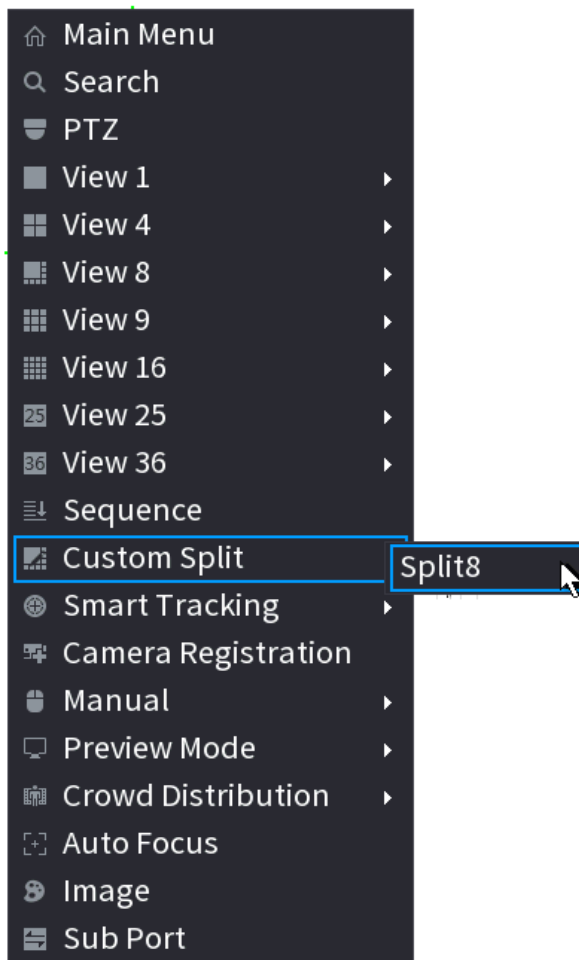

4.17 Audio

The audio function is to manage audio files and set schedule play function. It is to realize audio broadcast activation function.



This function is for some series product only.

4.17.1 File Management

Background Information

You can add audio files, listen to audio files, rename and delete audio files, and configure the audio volume.

Procedure

- Step 1** Select **Main Menu > AUDIO > File Management**.
The **File Management** interface is displayed. See Figure 4-297.

Figure 4-297 File management

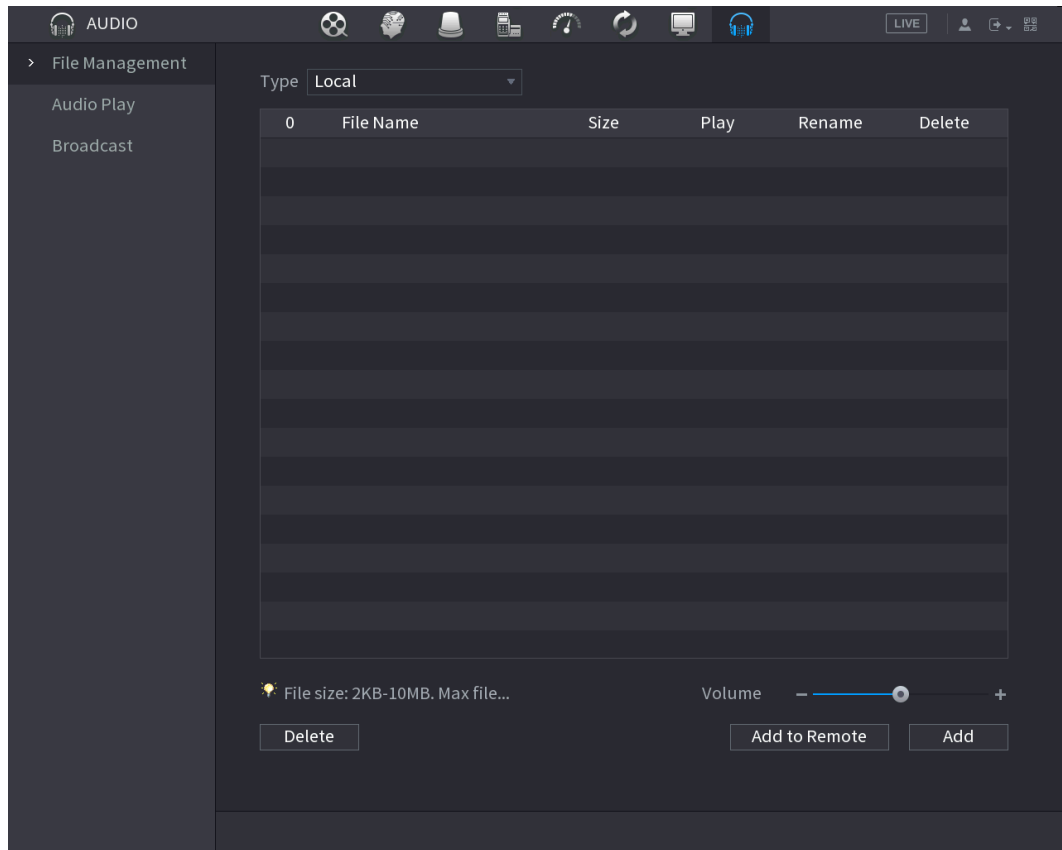

- Step 2** Click **Add**.
The **Add** interface is displayed. See Figure 4-298.



NVR supports USB port to import audio file only.

Figure 4-298 Add file

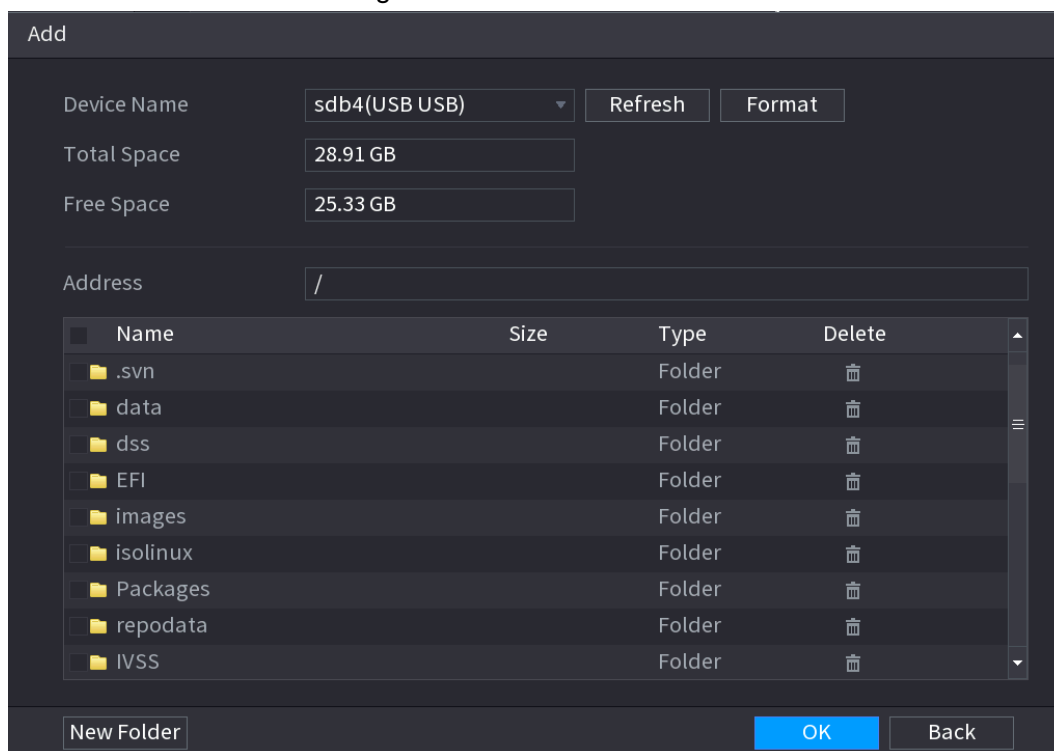

Step 3 Select the audio file and then click **Import**.

System supports MP3 and PCM audio format.

Step 4 Click **OK** to start importing audio files from the USB storage device.

If the importing is successful, the audio files will display in the **File Management** interface.

4.17.2 Audio Play

Background Information

You can configure the settings to play the audio files during the defined time period.

Procedure

Step 1 Select **Main Menu > AUDIO > Schedule**.

The **Schedule** interface is displayed. See Figure 4-299.

Figure 4-299 Schedule

Period	File Name	Interval	Loop	Output...
<input type="checkbox"/> 00 : 00 - 24 : 00	None	60 min.	0	Mic
<input type="checkbox"/> 00 : 00 - 24 : 00	None	60 min.	0	Mic
<input type="checkbox"/> 00 : 00 - 24 : 00	None	60 min.	0	Mic
<input type="checkbox"/> 00 : 00 - 24 : 00	None	60 min.	0	Mic
<input type="checkbox"/> 00 : 00 - 24 : 00	None	60 min.	0	Mic
<input type="checkbox"/> 00 : 00 - 24 : 00	None	60 min.	0	Mic

Step 2 Configure the settings for the schedule parameters. See Table 4-98.

Table 4-98 Schedule parameters

Parameter	Description
Period	In the Period box, enter the time. Select the check box to enable the settings. You can configure up to six periods.
File Name	In the File Name list, select the audio file that you want to play for this configured period.
Interval	In the Interval box, enter the time in minutes for how often you want to repeat the playing.
Loop	Configure how many times you want to repeat the playing in the defined period.
Output	Includes two options: MIC and Audio. It is MIC by default. The MIC function shares the same port with talkback function and the latter has the priority.  Some series products do not have audio port. The actual product shall prevail.



- The finish time for audio playing depends on audio file size and the configured interval.
- Playing priority: Alarm event > Audio talk > Trial listening > Schedule audio file.

Step 3 Click **Apply** to complete the settings.

4.17.3 Broadcast

Background Information

System can broadcast to the camera, or broadcast to a channel group.

Procedure

Step 1 Select **Mani Menu > AUDIO > Broadcast**.

The **Broadcast** interface is displayed. See Figure 4-300.



- On the broadcast interface, click to change group setup, click to delete group.
- After complete broadcast setup, on the preview interface and then click on the navigation bar, device pops up broadcast dialogue box. Select a group name and then click to begin broadcast. See Figure 4-302.

Figure 4-302 Add group (2)

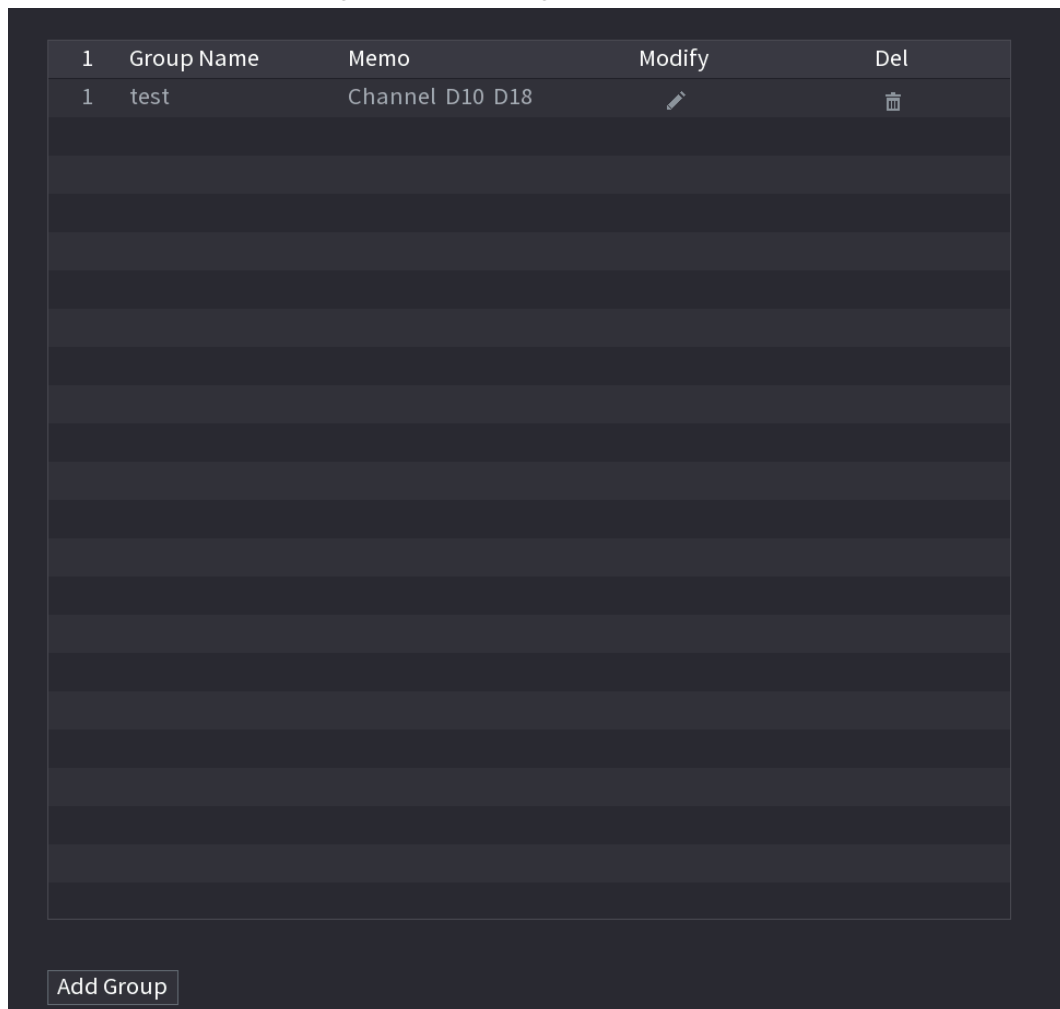

4.18 USB Device Auto Pop-up

After you inserted the USB device, system can auto detect it and pop up the following dialogue box. It allows you to conveniently backup file, log, configuration or update system. See Figure 4-303.

Refer to "4.17.1 File Management", "4.10.1 Log", IMP/EXP, and "4.10.4.4 System Update" for detailed information.



You can add a USB keyboard through USB port, and it can input characters limited to soft keyboard.

Figure 4-303 USB device prompt

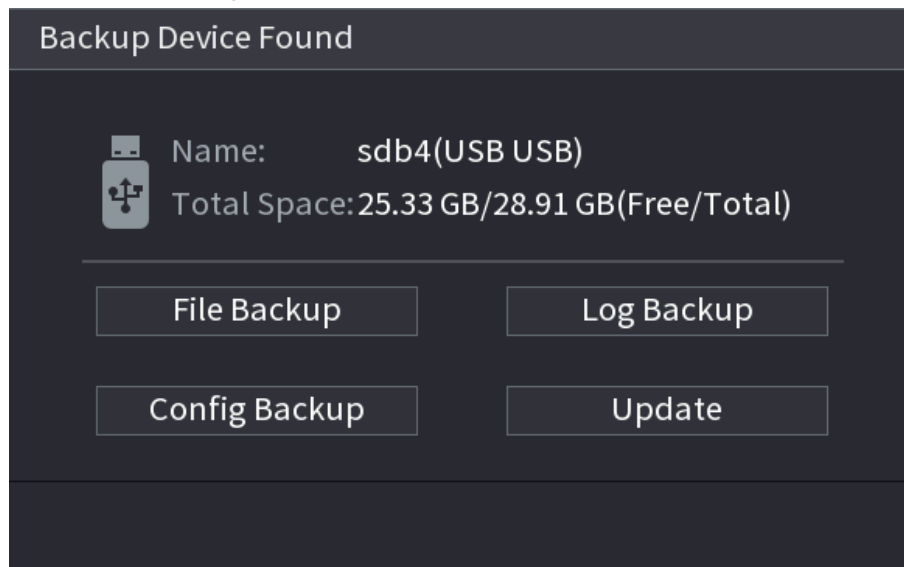

4.19 Shutdown



- When you see corresponding dialogue box "System is shutting down..." Do not click power on-off button directly.
- Do not unplug the power cable or click power on-off button to shutdown device directly when device is running (especially when it is recording.)
- Shut down the device and then unplug the power cable before you replace the HDD.

Procedure

- From the main menu (Recommended)
 1. Click  at the top right corner. See Figure 4-304.

Figure 4-304 Shutdown (1)



2. Select **Shutdown**.

Draw the unlock pattern or input password first if you have no authority to shut down.
See Figure 4-305 or Figure 4-306

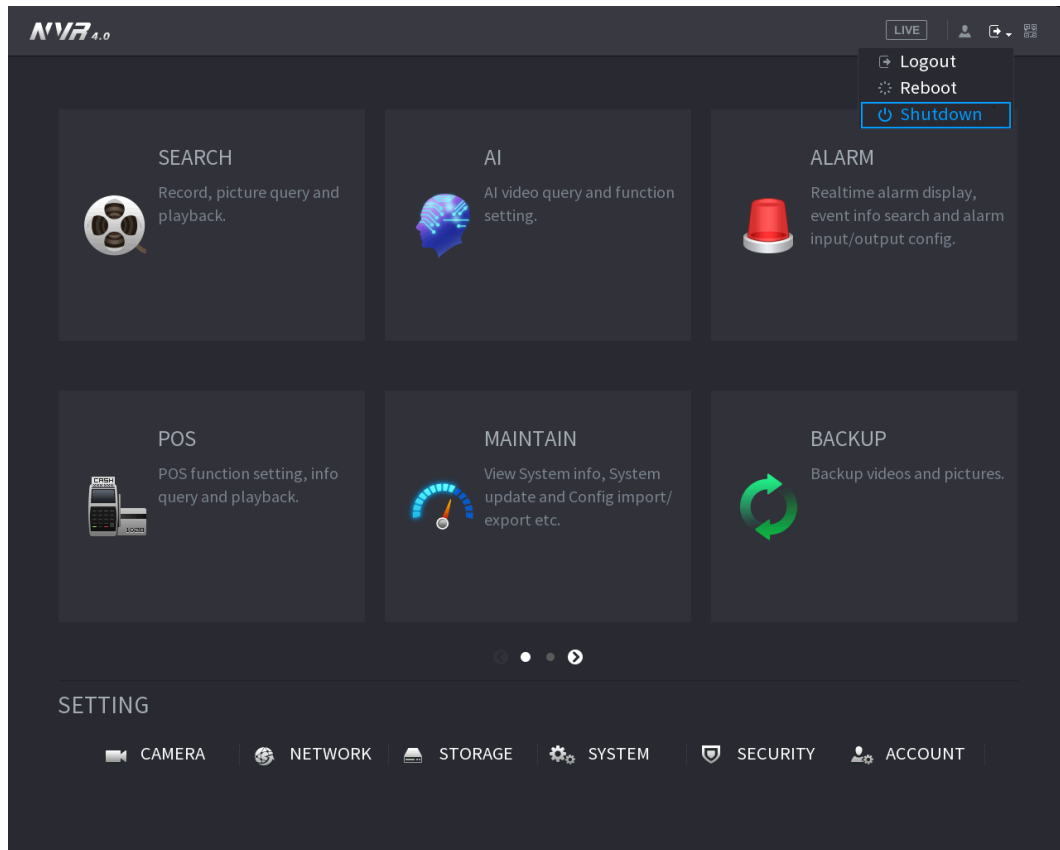
Figure 4-305 Shutdown (2)

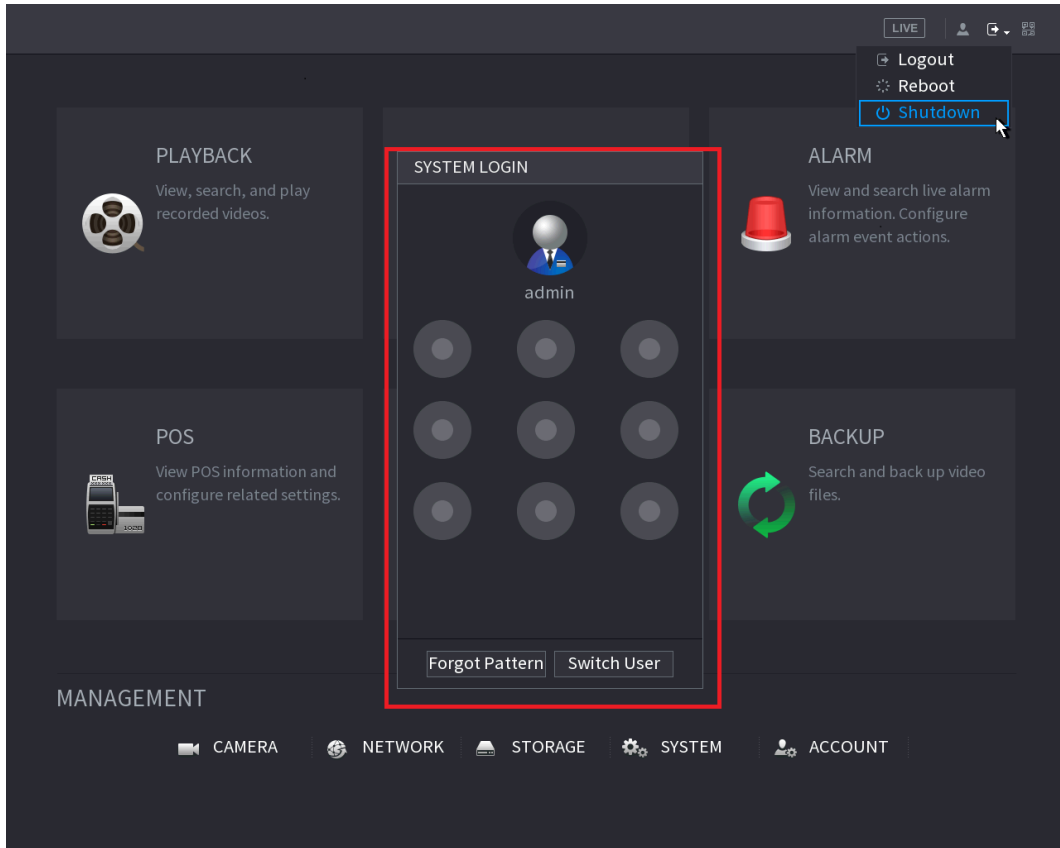
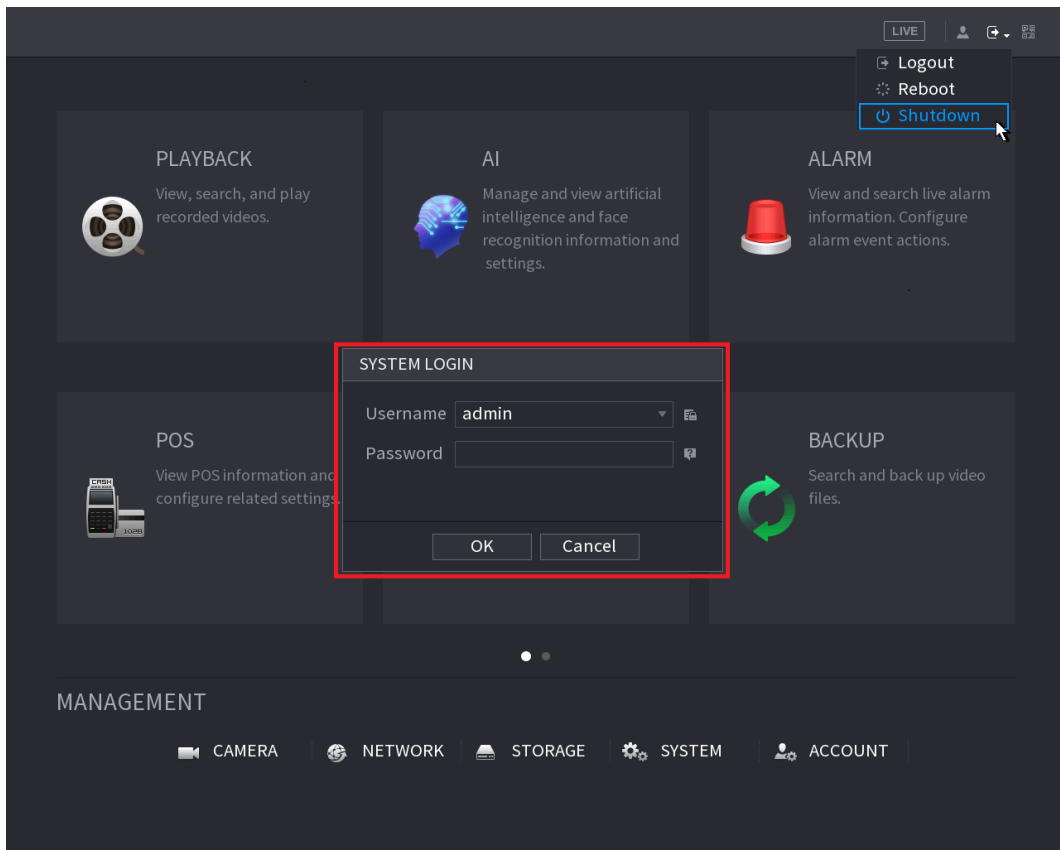

Figure 4-306 Shutdown (3)



- Remote Control
Press the power button on the remote for at least 3 seconds.

- Press the power button at the rear panel of the device.

Auto Resume after Power Failure

The system can automatically backup video file and resume previous working status after power failure.

5 Web Operation



- The interfaces in the Manual are used for introducing the operations and only for reference. The actual interface might be different dependent on the model you purchased. If there is inconsistency between the Manual and the actual product, the actual product shall govern.
- The Manual is a general document for introducing the product, so there might be some functions described for the Device in the Manual not apply to the model you purchased.
- Besides Web, you can use our Smart PSS to login the device. For detailed information, refer to Smart PSS user's manual.

5.1 Network Connection

Background Information



- The factory default IP of the Device is 192.168.1.108.
- The Device supports monitoring on different browsers such as Safari, Firefox, Google to perform the functions such as multi-channel monitoring, PTZ control, and device parameters configurations.

Procedure

- Step 1 Check to make sure the Device has connected to the network.
- Step 2 Configure the IP address, subnet mask and gateway for the PC and the Device. For details about network configuration of the Device, refer to "4.10.3 Network".
- Step 3 On your PC, check the network connection of the Device by using "ping ***.***.***.***". Usually the return value of TTL is 255.

5.2 Web Login

Procedure

- Step 1 Open the browser, enter the IP address of the Device, and then press Enter. The Login in dialog box is displayed. See Figure 5-1.

Figure 5-1 Login page

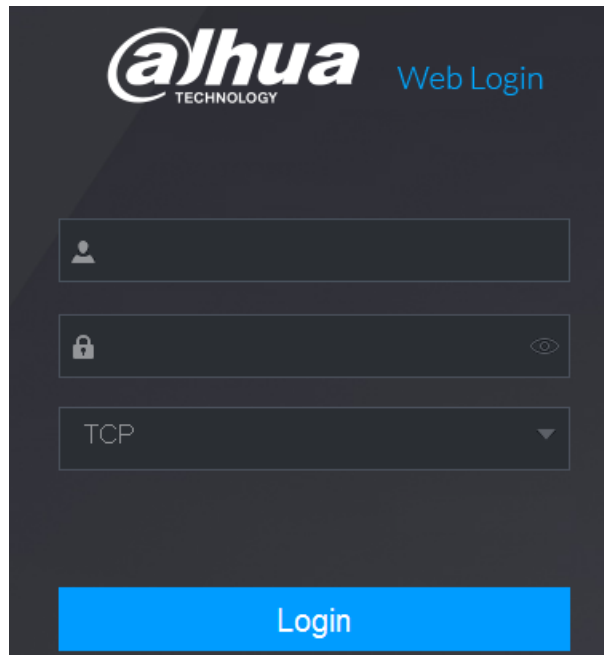

Step 2 Enter the user name and password.



- The default administrator account is **admin**. The password is the one that was configured during initial settings. To security your account, it is recommended to keep the password properly and change it regularly.
- Click  to display the password.

Step 3 Click **Login**.

5.3 Web Main Menu

After you have logged in the Web, the main menu is displayed. See Figure 5-2. For detailed operations, you can refer to "4 Local Basic Operation".

Figure 5-2 Main menu

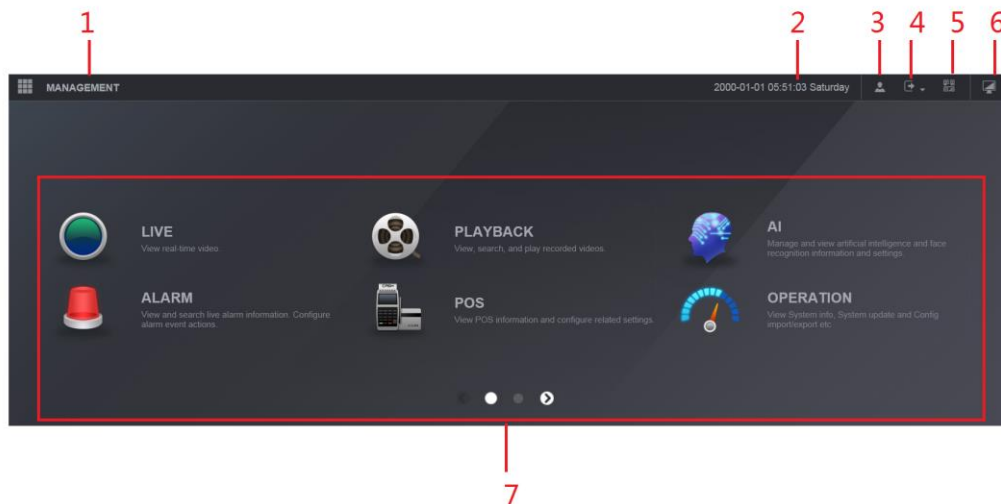

Table 5-1 Main menu symbols

No.	Icon	Description
1		Includes configuration menu through which you can configure camera settings, network settings, storage settings, system settings, account settings, and view information.
2	None	Displays system date and time.
3		When you point to , the current user account is displayed.
4		Click , select Logout, Reboot, or Shutdown according to your actual situation.
5		Displays Cell Phone Client and Device SN QR Code. <ul style="list-style-type: none"> Cell Phone Client: Use your mobile phone to scan the QR code to add the device into the Cell Phone Client, and then you can start accessing the Device from your cell phone. Device SN: Obtain the Device SN by scanning the QR code. Go to the P2P management platform and add the Device SN into the platform. Then you can access and manage the device in the WAN. For details, refer to the P2P operation manual. You can also configure P2P function in the local configurations, refer to "4.11.17 P2P".
6		Displays the web main menu.

No.	Icon	Description
7	None	<p>Includes eight function tiles: LIVE, PLAYBACK, AI, ALARM, POS, OPERATION, BACKUP, DISPLAY, and AUDIO. Click each tile to open the configuration interface of the tile.</p> <ul style="list-style-type: none"> ● LIVE: You can perform the operations such as viewing real-time video, configuring channel layout, setting PTZ controls, and using smart talk and instant record functions if needed. ● PLAYBACK: Search for and play back the recorded video saved on the Device. ● ALARM: Search for alarm information and configure alarm event actions. ● AI: Configure and manage artificial intelligent events. It includes smart search, parameters, and database. ● POS: View POS information and configure related settings. ● OPERATION: View system information, import/export system configuration files, or update system. ● BACKUP: Search and back up the video files to the local PC or external storage device such as USB storage device. ● DISPLAY: Configure the display effect such as displaying content, image transparency, and resolution, and enable the zero-channel function. ● AUDIO: Manage audio files and configure the playing schedule. The audio file can be played in response to an alarm event if the voice prompts function is enabled.

5.4 Cluster Service

The Cluster service is a system component used to control activities on a single node.

In a cluster, there can be N master devices and M slave devices (i.e., N+M mode).

When the master device fails, the slave device will replace the master device according to its configuration and cluster IP address, and the slave device will automatically send the video back to the master device after the master device is restored.

There are two standards when the master device is in malfunction: 1) Device is offline. 2) Device storage is damaged.



This function is only supported by select models. The actual product shall prevail.

5.4.1 Cluster IP

Background Information

About Cluster service: when master device is in malfunction, the slave device can use the

master device configuration and virtual IP address to replace the work (monitor or record) accordingly. When you use the virtual IP to access the device, he can still view the real-time video and there is no risk of record loss. Once the master device becomes properly, the slave can still work until you use the web to fix manually.

During the whole process (the master device is working properly > master device is in malfunction > master device becomes working properly again), you can use this virtual IP to access the device all the time.

Procedure

Step 1 Log in to the web as the admin user.

Step 2 Select **SETTING** > **Cluster Service** > **CLUSTER IP**.

Figure 5-3

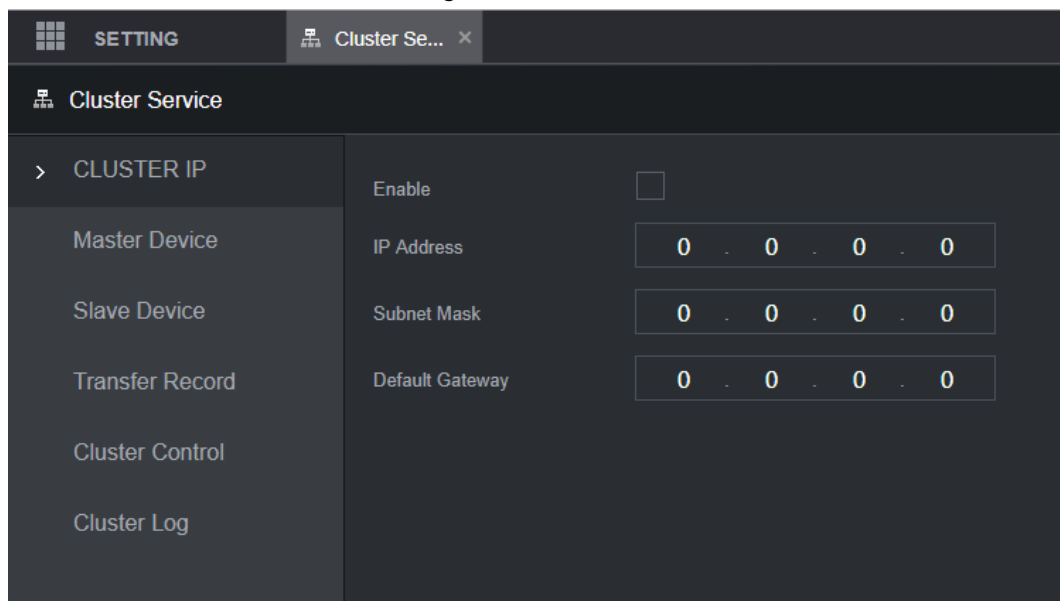

Step 3 Configure **IP Address**, **Subnet Mask** and **Default Gateway**.



The first IP is for cluster internal control (For interactive communications between the master device and slave device .), the virtual IP address is for cluster external control (For external network connection).

Step 4 Click **OK**.

5.4.2 Master Device

Background Information

From **SETTING** > **Cluster Service** > **Master Device**, you can go to the following interface. See Figure 5-4.

Figure 5-4

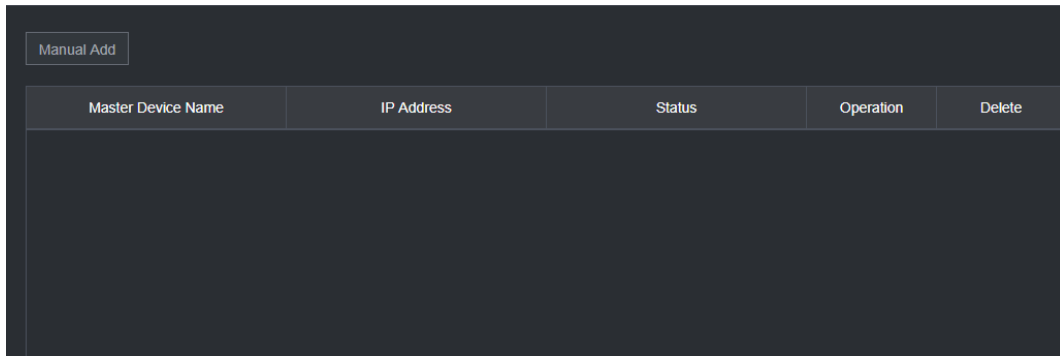

On this interface, you can add several master devices manually. After you enable the cluster function, you can view device IP, work status. Click operation, you can view the connection log of the main device.

Procedure

Step 1 Click **Manual Add**.

Figure 5-5

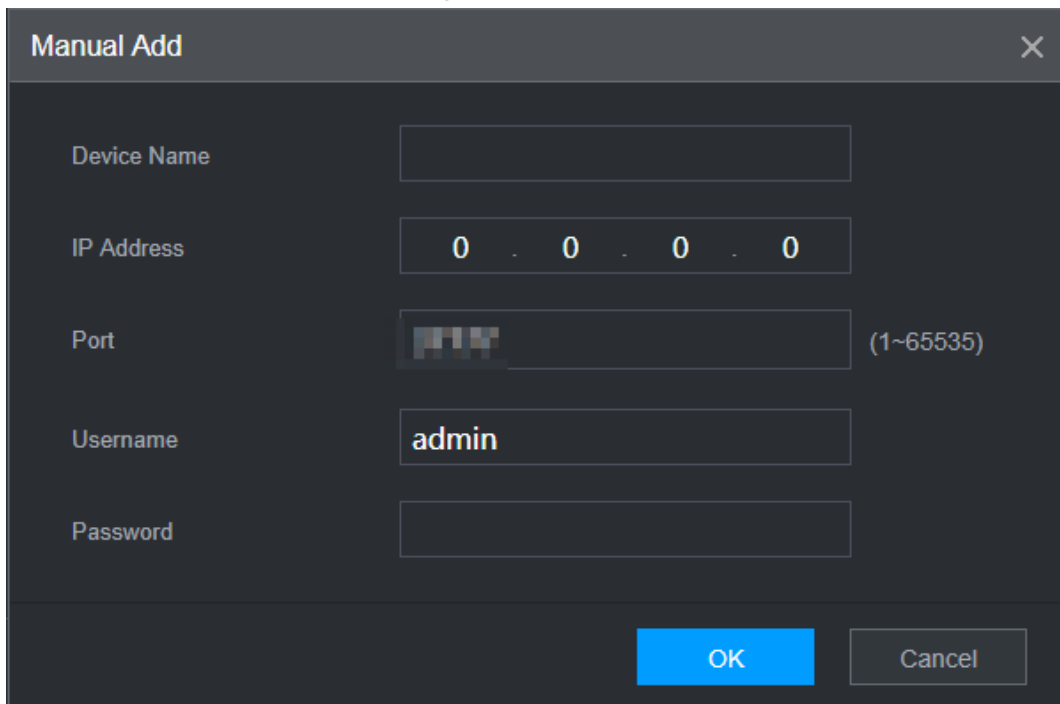

Step 2 Configure parameters.

Table 5-2

Parameter	Description
Device Name	This parameter is user defined.
IP Address	Enter the IP address of the NVR.
Port	Set the TCP port number of the server. The default vaule is 37777.  You can view the current TCP port number in SETTING > Network > Port
Username/Password	Enter the username and password of the NVR.

Step 3 Click **OK**.

Step 4 (Optional) Click  to view event occurrence time, name, operation and reason.

Figure 5-6



5.4.3 Slave Device

Background Information

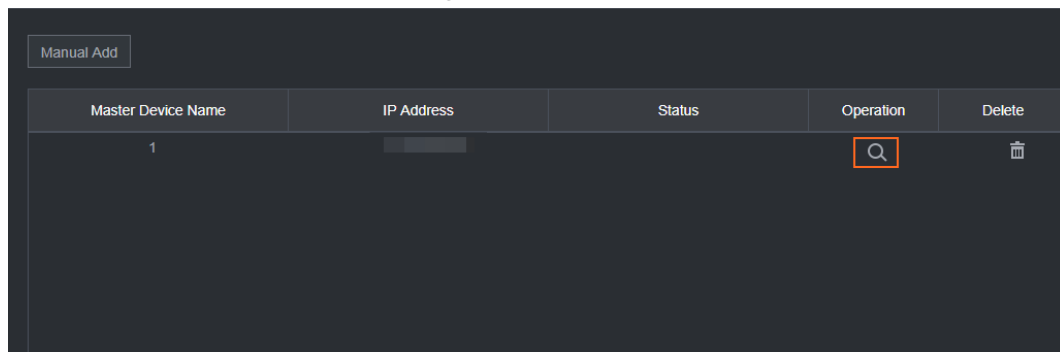
When you add the first slave device, the default IP is the device IP address that logs on the web.

From **SETTING > Cluster Service > Master Device**, you can go to the following interface. See Figure 5-7.

Figure 5-7

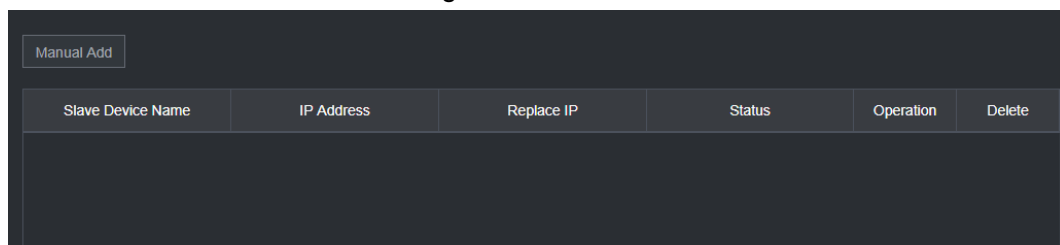

See "5.4.2 Master Device" to add slave device.

After you added master device and slave device , you need to enable cluster function. Otherwise, cluster function is null. See "5.4.5 Cluster Control" for more information.

5.4.4 Transfer Record

When the master device is in malfunction and the slave device starts to record. The NVR automatically transfers video records from slave device when the main device is working normally. You can also manually transfer video records from slave device to the main device.

Prerequisites

The master device works normally.

Procedure

Step 1 Select **SETTING > Cluster Service > Transfer Recorder**.

Step 2 Click **Add Task**.

Step 3 Configure parameters.

Figure 5-8

Step 4 Click **OK**.

You can click  to view the transfer information.

5.4.5 Cluster Control

5.4.5.1 Cluster Control

Background Information

From **SETTING > Cluster Service > Cluster Control**, you can go to the **Cluster Control** interface. It is to enable/disable cluster. See Figure 5-9.

Figure 5-9

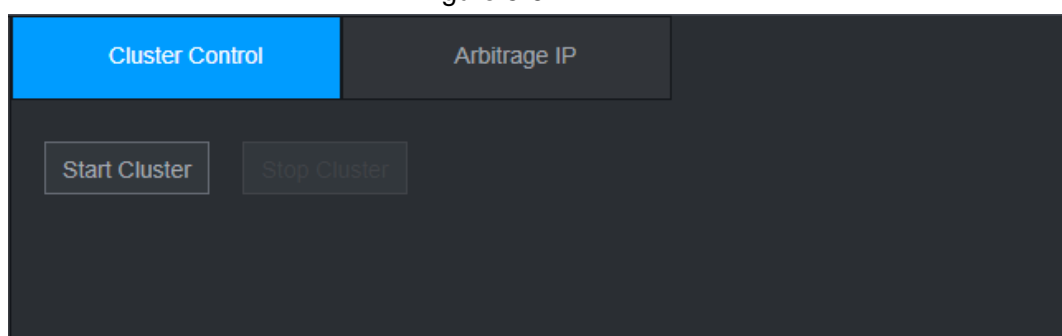

You can see the corresponding prompt if you successfully enabled cluster service.

5.4.5.2 Arbitrage IP

Background Information

When there is only two NVRs in the cluster, you can set the arbitration IP to change the cluster

accordingly. The arbitration IP is the IP address of other device/PC/gateway that can connect to the NVR.

From **SETTING > Cluster Service > Arbitrage IP**, you can see the following interface. See Figure 5-10.

Figure 5-10

Cluster Control	Arbitrage IP
Preferred IP	0 . 0 . 0 . 0
Alternate IP	0 . 0 . 0 . 0

5.4.6 Cluster Log

Background Information

From **SETTING > Cluster Service > Cluster Log**, you can go to the **Cluster Log** interface. The Cluster log interface is shown as in Figure 5-11.

Figure 5-11

No.	Time	Event	Details

Here you can search and view the Cluster log.

6 Glossary

- **DHCP:** DHCP (Dynamic Host Configuration Protocol) is a network protocol. It is one of the TCP/IP protocol cluster. It is principally used to assign temporary IP addresses to computers on a network.
- **DDNS:** DDNS (Dynamic Domain Name Server) is a service that maps Internet domain names to IP addresses. This service is useful to anyone who wants to operate a server (web server, mail server, ftp server and etc) connected to the internet with a dynamic IP or to someone who wants to connect to an office computer or server from a remote location with software.
- **eSATA:** eSATA(External Serial AT) is an interface that provides fast data transfer for external storage devices. It is the extension specifications of a SATA interface.
- **GPS:** GPS (Global Positioning System) is a satellite system, protected by the US military, safely orbiting thousands of kilometers above the earth.
- **PPPoE:** PPPoE (Point to Point Protocol over Ethernet) is a specification for connecting multiple computer users on an Ethernet local area network to a remote site. Now the popular mode is ADSL and it adopts PPPoE protocol.
- **Wi-Fi:** Wi-Fi is the name of a popular wireless networking technology that uses radio waves to provide wireless high-speed Internet and network connections. The standard is for wireless local area networks (WLANs). It is like a common language that all the devices use to communicate to each other. It is actually IEEE802.11, a family of standard The IEEE (Institute of Electrical and Electronics Engineers Inc.)
- **3G:** 3G is the wireless network standard. It is called 3G because it is the third generation of cellular telecom standards. 3G is a faster network for phone and data transmission and speed is over several hundred kbps. Now there are four standards: CDMA2000, WCDMA, TD-SCDMA and WiMAX.
- **Dual-stream:** The dual-stream technology adopts high-rate bit stream for local HD storage such as QCIF/CIF/2CIF/DCIF/4CIF encode and one low-rate bit stream for network transmission such as QCIF/CIF encode. It can balance the local storage and remote network transmission. The dual-stream can meet the difference band width requirements of the local transmission and the remote transmission. In this way, the local transmission using high-bit stream can achieve HD storage and the network transmission adopting low bit stream suitable for the fluency requirements of the 3G network such as WCDMA, EVDO, TD-SCDMA..
- **On-off value:** It is the non-consecutive signal sampling and output. It includes remote sampling and remote output. It has two statuses: 1/0.

7 FAQ

Questions	Solutions
NVR cannot boot up properly.	<ul style="list-style-type: none"> ● Input power is not correct. ● Power connection is not correct. ● Power switch button is damaged. ● Program upgrade is wrong. ● HDD malfunction or something wrong with HDD ribbon. ● Seagate DB35.1, DB35.2, SV35 or Maxtor 17-g has compatibility problem. Upgrade to the latest version to solve this problem. ● Front panel error. ● Main board is damaged.
NVR often automatically shuts down or stops running.	<ul style="list-style-type: none"> ● Input voltage is not stable or it is too low. ● HDD malfunction or something wrong with the ribbon. ● Button power is not enough. ● Front video signal is not stable. ● Working environment is too harsh, too much dust. ● Hardware malfunction.
System cannot detect hard disk.	<ul style="list-style-type: none"> ● HDD is broken. ● HDD ribbon is damaged. ● HDD cable connection is loose. ● Main board SATA port is broken.
There is no video output whether it is one-channel, multiple-channel or all-channel output.	<ul style="list-style-type: none"> ● Program is not compatible. Upgrade to the latest version. ● Brightness is 0. Restore factory default setup. ● Check your screen saver. ● NVR hardware malfunctions.
I cannot search local records.	<ul style="list-style-type: none"> ● HDD ribbon is damaged. ● HDD is broken. ● Upgraded program is not compatible. ● The recorded file has been overwritten. ● Record function has been disabled.
Video is distorted when searching local records.	<ul style="list-style-type: none"> ● Video quality setup is too low. ● Program read error, bit data is too small. There is mosaic in the full screen. Restart the NVR to solve this problem. ● HDD data ribbon error. ● HDD malfunction. ● NVR hardware malfunctions.
Time display is not correct.	<ul style="list-style-type: none"> ● Setup is not correct. ● Battery contact is not correct or voltage is too low. ● Crystal is broken.

Questions	Solutions
NVR cannot control PTZ.	<ul style="list-style-type: none"> ● Front panel PTZ error ● PTZ decoder setup, connection or installation is not correct. ● Cable connection is not correct. ● PTZ setup is not correct. ● PTZ decoder and NVR protocol is not compatible. ● PTZ decoder and NVR address is not compatible. ● When there are several decoders, add 120 Ohm between the PTZ decoder A/B cables furthest end to delete the reverberation or impedance matching. Otherwise the PTZ control is not stable. ● The distance is too far.
I cannot log in client-end or web.	<ul style="list-style-type: none"> ● For Windows 98 or Windows ME user, update your system to Windows 2000 sp4. Or you can install client-end software of lower version. Please note right now, our NVR is not compatible with Windows VISTA control. ● ActiveX control has been disabled. ● No dx8.1 or higher. Upgrade display card driver. ● Network connection error. ● Network setup error. ● Password or user name is invalid. ● Client-end is not compatible with NVR program.
There is only mosaic no video when preview or playback video file remotely.	<ul style="list-style-type: none"> ● Network fluency is not good. ● Client-end resources are limit. ● Current user has no right to monitor.
Network connection is not stable.	<ul style="list-style-type: none"> ● Network is not stable. ● IP address conflict. ● MAC address conflict. ● PC or device network card is not good.
Burn error /USB back error.	<ul style="list-style-type: none"> ● Burner and NVR are in the same data cable. ● System uses too much CPU resources. Stop record first and then begin backup. ● Data amount exceeds backup device capacity. It may result in burner error. ● Backup device is not compatible. ● Backup device is damaged.
Keyboard cannot control NVR.	<ul style="list-style-type: none"> ● NVR serial port setup is not correct. ● Address is not correct. ● When there are several switchers, power supply is not enough. ● Transmission distance is too far.

Questions	Solutions
Alarm signal cannot be disarmed.	<ul style="list-style-type: none"> ● Alarm setup is not correct. ● Alarm output has been open manually. ● Input device error or connection is not correct. ● Some program versions may have this problem. Upgrade your system.
Alarm function is null.	<ul style="list-style-type: none"> ● Alarm setup is not correct. ● Alarm cable connection is not correct. ● Alarm input signal is not correct. ● There are two loops connect to one alarm device.
Record storage period is not enough.	<ul style="list-style-type: none"> ● Camera quality is too low. Lens is dirty. Camera is installed against the light. Camera aperture setup is not correct. ● HDD capacity is not enough. ● HDD is damaged.
Cannot playback the downloaded file.	<ul style="list-style-type: none"> ● There is no media player. ● No DXB8.1 or higher graphic acceleration software. ● There is no DivX503Bundle.exe control when you play the file transformed to AVI via media player. ● No DivX503Bundle.exe or ffdshow-2004 1012 .exe in Windows XP OS.
Forgot local menu operation password or network password	Contact your local service engineer or our sales person for help. We can guide you to solve this problem.
There is no video. The screen is in black.	<ul style="list-style-type: none"> ● IPC IP address is not right. ● IPC port number is not right. ● IPC account (user name/password) is not right. ● IPC is offline.
The displayed video is not full in the monitor.	Check current resolution setup. If the current setup is 1920*1080, then you need to set the monitor resolution as 1920*1080.
There is no HDMI output.	<ul style="list-style-type: none"> ● Displayer is not in HDMI mode. ● HDMI cable connection is not right.
The video is not fluent when I view in multiple-channel mode from the client-end.	<ul style="list-style-type: none"> ● The network bandwidth is not sufficient. The multiple-channel monitor operation needs at least 100M or higher. ● Your PC resources are not sufficient. For 16-ch remote monitor operation, the PC shall have the following environment: Quad Core, 2G or higher memory, independent displayer, display card memory 256M or higher.

Questions	Solutions
I cannot connect to the IPC	<ul style="list-style-type: none"> • Make sure that the IPC has booted up. • IPC network connection is right and it is online • IPC IP is in the blacklist. • The device has connected to the too many IPC. It cannot transmit the video. • Check the IPC port value and the time zone is the same as the NVR. • Make sure current network environment is stable.
After I set the NVR resolution as 1080P, my monitor cannot display.	Shut down the device and then reboot. When you reboot, press the Fn button at the same time and then release after 5 seconds. You can restore NVR resolution to the default setup.
My admin account has been changed and I cannot log in.	Use telnet and then input the following command: <pre>cd /mnt/mtd/Config/ rm -rf group rm -rf password</pre> Reboot the device to restore the default password.
After I login the Web, I cannot find the remote interface to add the IPC.	Clear the Web controls and load again.
There is IP and gateway, I can access the internet via the router. But I cannot access the internet after I reboot the NVR.	Use command PING to check you can connect to the gateway or not. Use telnet to access and then use command "ifconfig -a" to check device IP address. If you see the subnet mask and the gateway has changed after the reboot. Upgrade the applications and set again.
I use the VGA monitor. I want to know if I use the multiple-window mode, I see the video from the main stream or the sub stream?	<ul style="list-style-type: none"> • For 32-channel series product, the 9/16-window is using the sub stream. • For 4/8/16 series product, system is using the main stream no matter you are in what display mode.

Daily Maintenance

- Use the brush to clean the board, socket connector and the chassis regularly.
- The device shall be soundly earthed in case there is audio/video disturbance. Keep the device away from the static voltage or induced voltage.
- Unplug the power cable before you remove the audio/video signal cable, RS-232 or RS-485 cable.
- Do not connect the TV to the local video output port (VOUT).It may result in video output circuit.
- Always shut down the device properly. Use the shutdown function in the menu, or you can press the power button in the rear pane for at least three seconds to shut down the device. Otherwise it may result in HDD malfunction.
- Make sure the device is away from the direct sunlight or other heating sources. Keep the sound ventilation.
- Check and maintain the device regularly.

Appendix 1 Cybersecurity Recommendations

Cybersecurity is more than just a buzzword: it's something that pertains to every device that is connected to the internet. IP video surveillance is not immune to cyber risks, but taking basic steps toward protecting and strengthening networks and networked appliances will make them less susceptible to attacks. Below are some tips and recommendations on how to create a more secured security system.

Mandatory actions to be taken for basic equipment network security

1. Use Strong Passwords

Please refer to the following suggestions to set passwords:

- The length should not be less than 8 characters;
- Include at least two types of characters; character types include upper and lower case letters, numbers and symbols;
- Do not contain the account name or the account name in reverse order;
- Do not use continuous characters, such as 123, abc, etc.;
- Do not use overlapped characters, such as 111, aaa, etc.;

2. Update Firmware and Client Software in Time

- According to the standard procedure in Tech-industry, we recommend to keep your equipment (such as NVR, DVR, IP camera, etc.) firmware up-to-date to ensure the system is equipped with the latest security patches and fixes. When the equipment is connected to the public network, it is recommended to enable the "auto-check for updates" function to obtain timely information of firmware updates released by the manufacturer.
- We suggest that you download and use the latest version of client software.

"Nice to have" recommendations to improve your equipment network security

1. Physical Protection

We suggest that you perform physical protection to equipment, especially storage devices. For example, place the equipment in a special computer room and cabinet, and implement well-done access control permission and key management to prevent unauthorized personnel from carrying out physical contacts such as damaging hardware, unauthorized connection of removable equipment (such as USB flash disk, serial port), etc.

2. Change Passwords Regularly

We suggest that you change passwords regularly to reduce the risk of being guessed or cracked.

3. Set and Update Passwords Reset Information Timely

The equipment supports password reset function. Please set up related information for password reset in time, including the end user's mailbox and password protection questions. If the information changes, please modify it in time. When setting password protection questions, it is suggested not to use those that can be easily guessed.

4. Enable Account Lock

The account lock feature is enabled by default, and we recommend you to keep it on to guarantee the account security. If an attacker attempts to log in with the wrong password several times, the corresponding account and the source IP address will be locked.

5. Change Default HTTP and Other Service Ports

We suggest you to change default HTTP and other service ports into any set of numbers between 1024~65535, reducing the risk of outsiders being able to guess which ports you are using.

6. Enable HTTPS

We suggest you to enable HTTPS, so that you visit Web service through a secure communication channel.

7. Enable Allowlist

We suggest you to enable allowlist function to prevent everyone, except those with specified IP addresses, from accessing the system. Therefore, please be sure to add your computer's IP address and the accompanying equipment's IP address to the allowlist.

8. MAC Address Binding

We recommend you to bind the IP and MAC address of the gateway to the equipment, thus reducing the risk of ARP spoofing.

9. Assign Accounts and Privileges Reasonably

According to business and management requirements, reasonably add users and assign a minimum set of permissions to them.

10. Disable Unnecessary Services and Choose Secure Modes

If not needed, it is recommended to turn off some services such as SNMP, SMTP, UPnP, etc., to reduce risks.

If necessary, it is highly recommended that you use safe modes, including but not limited to the following services:

- SNMP: Choose SNMP v3, and set up strong encryption passwords and authentication passwords.
- SMTP: Choose TLS to access mailbox server.
- FTP: Choose SFTP, and set up strong passwords.
- AP hotspot: Choose WPA2-PSK encryption mode, and set up strong passwords.

11. Audio and Video Encrypted Transmission

If your audio and video data contents are very important or sensitive, we recommend that you use encrypted transmission function, to reduce the risk of audio and video data being stolen during transmission.

Reminder: encrypted transmission will cause some loss in transmission efficiency.

12. Secure Auditing

- Check online users: we suggest that you check online users regularly to see if the device is logged in without authorization.
- Check equipment log: By viewing the logs, you can know the IP addresses that were used to log in to your devices and their key operations.

13. Network Log

Due to the limited storage capacity of the equipment, the stored log is limited. If you need to save the log for a long time, it is recommended that you enable the network log function to ensure that the critical logs are synchronized to the network log server for tracing.

14. Construct a Safe Network Environment

In order to better ensure the safety of equipment and reduce potential cyber risks, we recommend:

- Disable the port mapping function of the router to avoid direct access to the intranet

devices from external network.

- The network should be partitioned and isolated according to the actual network needs. If there are no communication requirements between two sub networks, it is suggested to use VLAN, network GAP and other technologies to partition the network, so as to achieve the network isolation effect.
- Establish the 802.1x access authentication system to reduce the risk of unauthorized access to private networks.
- It is recommended that you enable your device's firewall or blacklist and allowlist feature to reduce the risk that your device might be attacked.

Appendix 2 HDD Capacity Calculation

Calculate total capacity needed by each device according to video recording (video recording type and video file storage time).

1. According to Formula (1) to calculate storage capacity q_i that is the capacity of each channel needed for each hour, unit Mbyte.

$$q_i = d_i \div 8 \times 3600 \div 1024 \quad (1)$$

In the formula: d_i means the bit rate, unit Kbit/s

2. After video time requirement is confirmed, according to Formula (2) to calculate the storage capacity m_i , which is storage of each channel needed unit Mbyte.

$$m_i = q_i \times h_i \times D_i \quad (2)$$

In the formula:

h_i means the recording time for each day (hour)

D_i means number of days for which the video shall be kept

3. According to Formula (3) to calculate total capacity (accumulation) q_T that is needed for all channels in the device during **scheduled video recording**.

$$q_T = \sum_{i=1}^c m_i \quad (3)$$

In the formula:

c means total number of channels in one device

4. According to Formula (4) to calculate total capacity (accumulation) q_T that is needed for all channels in device during **alarm video recording (including motion detection)**.

$$q_T = \sum_{i=1}^c m_i \times a\% \quad (4)$$

In the formula: $a\%$ means alarm occurrence rate

Appendix 3 Compatible Network Camera List

Please note all the models in the following list for reference only. For those products not included in the list, please contact your local retailer or technical supporting engineer for detailed information.

Appendix Table 3-1

Manufacturer	Model	Version	Video Encode	Audio/Video	Protocol
AXIS	P1346	5.40.9.2	H264	√	ONVIF/Private
	P3344/P3344-E	5.40.9.2	H264	√	ONVIF/Private
	P5512	—	H264	√	ONVIF/Private
	Q1604	5.40.3.2	H264	√	ONVIF/Private
	Q1604-E	5.40.9	H264	√	ONVIF/Private
	Q6034E	—	H264	√	ONVIF/Private
	Q6035	5.40.9	H264	√	ONVIF/Private
	Q1755	—	H264	√	ONVIF/Private
	M7001	—	H264	√	Private
	M3204	5.40.9.2	H264	√	Private
	P3367	HEAD LFP4_0 130220	H264	√	ONVIF
	P5532-P	HEAD LFP4_0 130220	H264	√	ONVIF
	ACTi	ACM-3511	A1D-220-V3 .12.15-AC	MPEG4	√
ACM-8221		A1D-220-V3 .13.16-AC	MPEG4	√	Private
Arecont	AV1115	65246	H264	√	Private
	AV10005DN	65197	H264	√	Private
	AV2115DN	65246	H264	√	Private
	AV2515DN	65199	H264	√	Private
	AV2815	65197	H264	√	Private
	AV5115DN	65246	H264	√	Private
	AV8185DN	65197	H264	√	Private

Manufacturer	Model	Version	Video Encode	Audio/Video	Protocol
Bosch	NBN-921-P	—	H264	√	ONVIF
	NBC-455-12P	—	H264	√	ONVIF
	VG5-825	9500453	H264	√	ONVIF
	NBN-832	66500500	H264	√	ONVIF
	VEZ-211-IWTEIVA	—	H264	√	ONVIF
	NBC-255-P	15500152	H264	√	ONVIF
	VIP-X1XF	—	H264	√	ONVIF
Brikcom	B0100	—	H264	√	ONVIF
	D100	—	H264	√	ONVIF
	GE-100-CB	—	H264	√	ONVIF
	FB-100A	v1.0.3.9	H264	√	ONVIF
	FD-100A	v1.0.3.3	H264	√	ONVIF
Cannon	VB-M400	—	H264	√	Private
CNB	MPix2.0DIR	XNETM1120111229	H264	√	ONVIF
	VIPBL1.3MIRVF	XNETM2100111229	H264	√	ONVIF
	IGC-2050F	XNETM2100111229	H264	√	ONVIF
CP PLUS	CP-NC9-K	6.E.2.7776	H264	√	ONVIF/Private
	CP-NC9W-K	6.E.2.7776	H264	√	Private
	CP-ND10-R	cp20111129ANS	H264	√	ONVIF
	CP-ND20-R	cp20111129ANS	H264	√	ONVIF
	CP-NS12W-CR	cp20110808NS	H264	√	ONVIF
	VS201	cp20111129NS	H264	√	ONVIF
	CP-NB20-R	cp20110808BNS	H264	√	ONVIF
	CP-NT20VL3-R	cp20110808BNS	H264	√	ONVIF
	CP-NS36W-AR	cp20110808NS	H264	√	ONVIF
	CP-ND20VL2-R	cp20110808BNS	H264	√	ONVIF

Manufacturer	Model	Version	Video Encode	Audio/Video	Protocol
	CP-RNP-1820	cp20120821NSA	H264	√	Private
	CP-RNC-TP20FL3C	cp20120821NSA	H264	√	Private
	CP-RNP-12D	cp20120828ANS	H264	√	Private
	CP-RNC-DV10	cp20120821NSA	H264	√	Private
	CP-RNC-DP20FL2C	cp20120821NSA	H264	√	Private
Dyncolor	ICS-13	d20120214NS	H264	√	ONVIF/Private
	ICS-20W	vt20111123NSA	H264	√	ONVIF/Private
	NA222	—	H264	√	ONVIF
	MPC-IPVD-0313	k20111208ANS	H264	√	ONVIF/Private
	MPC-IPVD-0313AF	k20111208BNS	H264	√	ONVIF/Private
Honeywell	HIDC-1100PT	h.2.2.1824	H264	√	ONVIF
	HIDC-1100P	h.2.2.1824	H264	√	ONVIF
	HIDC-0100P	h.2.2.1824	H264	√	ONVIF
	HIDC-1300V	2.0.0.21	H264	√	ONVIF
	HICC-1300W	2.0.1.7	H264	√	ONVIF
	HICC-2300	2.0.0.21	H264	√	ONVIF
	HDZ20HDX	H20130114NSA	H264	√	ONVIF
LG	LW342-FP	—	H264	√	Private
	LNB5100	—	H264	√	ONVIF
Imatek	KNC-B5000	—	H264	√	Private
	KNC-B5162	—	H264	√	Private
	KNC-B2161	—	H264	√	Private
Panasonic	NP240/CH	—	MPEG4	√	Private
	WV-NP502	—	MPEG4	√	Private
	WV-SP102H	1.41	H264	√	ONVIF/Private
	WV-SP105H	—	H264	√	ONVIF/Private

Manufacturer	Model	Version	Video Encode	Audio/Video	Protocol
	WV-SP302H	1.41	H264, MPEG4	√	ONVIF/Private
	WV-SP306H	1.4	H264, MPEG4	√	ONVIF/Private
	WV-SP508H	—	H264, MPEG4	√	ONVIF/Private
	WV-SP509H	—	H264, MPEG4	√	ONVIF/Private
	WV-SF332H	1.41	H264, MPEG4	√	ONVIF/Private
	WV-SW316H	1.41	H264, MPEG4	√	ONVIF/Private
	WV-SW355H	1.41	H264, MPEG4	√	ONVIF/Private
	WV-SW352H	—	H264, MPEG4	√	ONVIF/Private
	WV-SW152E	1.03	H264, MPEG4	√	ONVIF/Private
	WV-SW558H	—	H264, MPEG4	√	ONVIF/Private
	WV-SW559H	—	H264, MPEG4	√	ONVIF/Private
	WV-SP105H	1.03	H264, MPEG4	√	ONVIF/Private
	WV-SW155E	1.03	H264, MPEG4	√	ONVIF/Private
	WV-SF336H	1.44	H264, MPEG4	√	ONVIF/Private
	WV-SF332H	1.41	H264, MPEG4	√	ONVIF/Private
	WV-SF132E	1.03	H264, MPEG4	√	ONVIF/Private
	WV-SF135E	1.03	H264, MPEG4	√	ONVIF/Private
	WV-SF346H	1.41	H264, MPEG4	√	ONVIF/Private
	WV-SF342H	1.41	H264, MPEG4	√	ONVIF/Private
	WV-SC385H	1.08	H264, MPEG4	√	ONVIF/Private
	WV-SC386H	1.08	H264, MPEG4	√	ONVIF/Private
	WV-SP539	1.66	H264, MPEG4	√	ONVIF

Manufacturer	Model	Version	Video Encode	Audio/Video	Protocol
	DG-SC385	1.66	H264, MPEG4	√	ONVIF
PELCO	IXSOLW	1.8.1-20110912-1.9082-A1.6617	H264	√	Private
	IDE20DN	1.7.41.9111-O3.6725	H264	√	Private
	D5118	1.7.8.9310-A1.5288	H264	√	Private
	IM10C10	1.6.13.9261-O2.4657	H264	√	Private
	DD4N-X	01.02.0015	MPEG4	√	Private
	DD423-X	01.02.0006	MPEG4	√	Private
	D5220	1.8.3-FC2-20120614-1.9320-A1.8035	H264	√	Private
Samsung	SNB-3000P	2.41	H264, MPEG4	√	ONVIF/Private
	SNP-3120	1.22_110120_1	H264, MPEG4	√	ONVIF/Private
	SNP-3370	1.21_110318	MPEG4	√	Private
	SNB-5000	2.10_111227	H264, MPEG4	√	ONVIF/Private
	SND-5080	—	H264, MPEG4	√	Private
	SNZ-5200	1.02_110512	H264, MPEG4	√	ONVIF/Private
	SNP-5200	1.04_110825	H264, MPEG4	√	ONVIF/Private
	SNB-7000	1.10_110819	H264	√	ONVIF/Private
	SNB-6004	V1.0.0	H264	√	ONVIF
Sony	SNC-DH110	1.50.00	H264	√	ONVIF/Private
	SNC-CH120	1.50.00	H264	√	ONVIF/Private
	SNC-CH135	1.73.01	H264	√	ONVIF/Private
	SNC-CH140	1.50.00	H264	√	ONVIF/Private
	SNC-CH210	1.73.00	H264	√	ONVIF/Private

Manufacturer	Model	Version	Video Encode	Audio/Video	Protocol
	SNC-DH210	1.73.00	H264	√	ONVIF/Private
	SNC-DH240	1.50.00	H264	√	ONVIF/Private
	SNC-DH240-T	1.73.01	H264	√	ONVIF/Private
	SNC-CH260	1.74.01	H264	√	ONVIF/Private
	SNC-CH280	1.73.01	H264	√	ONVIF/Private
	SNC-RH-124	1.73.00	H264	√	ONVIF/Private
	SNC-RS46P	1.73.00	H264	√	ONVIF/Private
	SNC-ER550	1.74.01	H264	√	ONVIF/Private
	SNC-ER580	1.74.01	H264	√	ONVIF/Private
	SNC-ER580	1.78.00	H264	√	ONVIF
	SNC-VM631	1.4.0	H264	√	ONVIF
	WV-SP306	1.61.00	H264, MPEG4	√	SDK
	WV-SP306	1.61.00	H264	√	ONVIF
	SNC-VB600	1.5.0	H264	√	Private
	SNC-VM600	1.5.0	H264	√	Private
	SNC-VB630	1.5.0	H264	√	Private
	SNC-VM630	1.5.0	H264	√	Private
SANYO	VCC-HDN4000PC	—	H264	√	ONVIF

ENABLING A SAFER SOCIETY AND SMARTER LIVING

ZHEJIANG DAHUA VISION TECHNOLOGY CO., LTD.

Address: No.1199 Bin'an Road, Binjiang District, Hangzhou, P. R. China | Website: www.dahuasecurity.com | Postcode: 310053

Email: overseas@dahuatech.com | Fax: +86-571-87688815 | Tel: +86-571-87688883